



A Living Brand

LifeCare
Surgical





Main office and factory:

Area No. 3, Block B,
Free Zone , Nasr city ,
Cairo - Egypt.

Phone: +202 672 03 14
 +202 672 03 15

Fax : +202 672 03 16
www.lifecaresi.com

6th October Factory:

6th October city .
Industrial Zone No. 3,
Carnival Industrial compaond
Giza - Egypt.

Phone: +202 672 03 15
Fax : +202 672 03 16



Chairman Word:

*T*o our country, to all the world and to the future, we founded lifeCare Surgical.

Starting from where others ended, adding the value of 30 years experience in the field of instrumentation.

Offering products with the best quality that appreciate health care and doctors needs.

Sherif Ezzat

Different type of finishing:

Black Finish:

Black instruments are recommended for use in Micro Surgeries, under microscope, as well as in large operating fields using large instruments such as big retractor. The black finish is very effective in preventing light reflection during surgeries and making them convenient for surgeons.



Extra Finish:

In this way we satisfy our customers who would like to make special marks or images on their own instruments. Upon special request we can make one instrument with two types of finishing. In this way one part of the instrument will be in mirror finish and the other part will be satin, Black or gold finish.



Mirror Finish:

Instruments made of high quality stainless steel provided in a shiny mirror finish. Those instruments are made upon customer request to this unique image and shine of silver. It gives the instrument a shape of dignity.



Electro Surgical:

Different types of electro surgical isolated instruments are available including standard electro surgery instruments as well as special electro surgery instruments according to your request and experience.





Production:

A complete chain of highly skilled technical experts working on up to date technology of machinery, using high grades of raw materials companied together in one place.

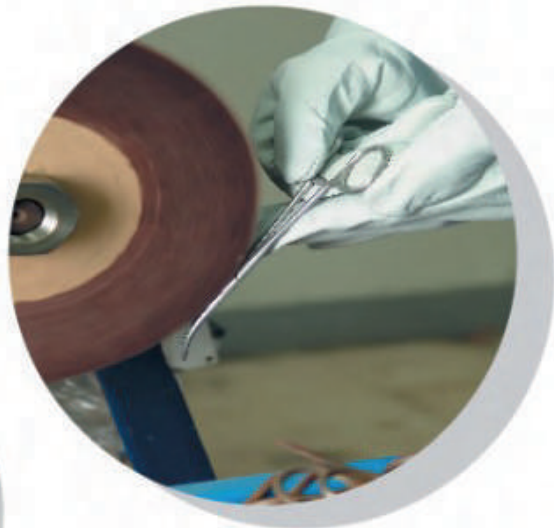

Quality Control:

We manufacture our products according to European standards.



We also enhanced our quality with high quality certificates ISO 14385/2003



Packing:

Using the EAN 128 international coding in a packing designed to take care of the safety of delicate instruments.

Delicate instruments packing

Regular packing



Certificate of CE-Registration



MDSS

Medical Device Safety Service

This is to certify that, in accordance with the Medical Device Directive 93/42/EEC, Medical Device Safety Service GmbH (MDSS) agrees to perform all duties and responsibilities as the Authorized Representative for:

**LifeCare Surgical Instruments
Area No. 3, Block B
Free Zone, Nasr City
11816 Cairo
EGYPT**

as stipulated and demanded by the aforementioned Directive. The German Competent Authority has allocated the medical devices of the Manufacturer registration numbers as foreseen in:

Annex A dated November 04, 2019

The Manufacturer has provided MDSS with the appropriate Declaration(s) of Conformity confirming that the medical devices fulfill the applicable requirements of Directive 93/42/EEC. In compliance with German law, a safety officer has been appointed for Germany.

2019-11-04



Dr. Philipp Hohenbrink
Senior Consultant
MDSS GmbH

Certificate of Registration

This certificate of Registration certifies that:

LIFECARE SURGICAL

**Carnaval Industrial Compound, 3rd Industrial Zone, 6th of October City,
Post code: 12563, Cairo - Egypt**

has registered with the US Food and Drug Administration pursuant to Title 21 of the United States Code of Federal Regulations.

**US FDA Registration Number: 3004577006
Owner Operator Number: 9063680**

**US Agent: Willow Glen Consultancy LLC
Willow Glen Number: WG1910MR2428
Expiration Date: December 30, 2020**

This certificate affirms that the above named facility is registered with the US FDA pursuant to the regulations required by the US laws. This registration has been verified as effective by Willow Glen Consultancy as of the date below, unless such registration has been terminated after issuance of this Certificate. Willow Glen Consultancy makes no additional representations or warranties, nor does this certificate carry any to any person or entity other than the named certificate holder, for whose sole benefit it is issued. Willow Glen Consultancy assumes no liability to any person or entity in connection with the foregoing, nor does the U.S. FDA recognize a certificate of registration issued by Willow Glen Consultancy.

Willow Glen Consultancy is a private agent not affiliated with the U.S. Food and Drug Administration.



**Amanda Ou, Operation Director
Willow Glen Consultancy LLC
+1-619-869-0249
Date: October 30, 2019**



Willow Glen

**WillowGlenFDA.com
Info@WillowGlenFDA.com
3755 Avocado Blvd, Suite 208
La Mesa, CA 91941, USA**



CERTIFICATE

This is to Certify that the Management System of

LIFE CARE SURGICAL INSTRUMENTS

FACTORY: AREA NO. 3, BLOCK B, FREE ZONE NASR CITY, CAIRO - EGYPT

WAREHOUSE: 6TH OF OCTOBER CITY, CARNIVAL INDUSTRIAL COMPOUND
CAIRO, GIZA - EGYPT

has been found to conform to the Medical Devices – Quality Management System standard:

ISO 13485:2016

This certificate is valid for the following scope of operations:

MANUFACTURING AND SALES OF SURGICAL INSTRUMENTS

Certificate No.: EG92109H

<u>Date of initial registration</u>	<u>Date of this Certificate</u>	<u>Surv. audit on or before/ Certificate expiry</u>	<u>Recertification Due</u>
30 April 2019*	20 March 2021	29 April 2022	29 April 2024

This Certificate remains valid subject to satisfactory surveillance audits.

*(Note:- Certification Registration is Transferred from Staunchly Management & System Services Pvt. Ltd.
So Date of Initial Registration is Subject to previous Registrar.



Director

For verification and updated information concerning the present certificate visit to www.lmscert.com

This Certificate is the property of LMS Certifications Private Limited and shall be returned immediately when demanded.



LMS Certifications Private Limited
1, Ananddham, Opp. Kukrail Picnic Spot Gate,
Faridi Nagar, Lucknow - 226015, U.P. (INDIA).
Phone : +91-9554645464
Visit :- www.lmscert.com
E-mail :- info@lmscert.com



INDEX

	Page
 A - Knives, scalpels 1 - Couteaux, bistouris - Cuchillos, bisturios	1
 B - Probes, spatulas, cotton carriers, suction tube and trocars 31 - Sondes, spatules, porte-cotons, canules aspiratoires, trocars - Sondas, espátulas, portaalgodones, cánulas de aspiración, trócares	31
 C - Forceps 58 - Pincers - Pinzas	58
 D - Clamps and forceps 78 - Pincers et pincers-clamps - Pinzas y pinzas-clamps	78
 E - Suture 200 - Suture - Sutura	200
 F - Scissors 221 - Ciseaux - Tijeras	221
 G - Retractors 270 - Ecarteurs - Separadores	270
 TC - Instruments with tungsten carbide inserts 372 - Instruments avec carbure de tungsten inséré - Instrumentos con inserciones de tungsteno	372
 H - Gynecology, obstetrics 410 - Gynécologie, obstétrique - Ginecología, obstetricia	410
 I - Stomach, intestine, rectum 438 - Estomac, intestin, rectum - Estómago, intestino, recto	438
 J - Mallets, chisels, gouges, osteotomes, curettes, rasps, elevators, dissectors 450 - Maillets, ciseaux-burins, gouges, ostéotomes, curettes tranchantes, limes et râpes à os, rugines, élévateurs, dissecteurs - Martillos y mazos, cucharillas cortantes, limas para huesos, escofinas, periostótomos, elevadores, disecadores	450
 K - Rongeurs 488 - Pincers-gouges - Pinzas gubias	488
 L - Bone surgery, orthopedics 534 - Chirurgie osseuse, orthopédie - Cirugía ósea, ortopedia	534
 N - Otology, rhinology, tonsillectomy 548 - Otologie, rhinologie, amygdalotomie - Otología, rinología, amigdalotomía	548
 O - Diagnostics 599 - Diagnostic - Diagnostico	599



- Knives, scalpels
- Couteaux, bistouris
- Cuchillos, bisturios



A-0020.##



Fig. 1
A-0020.01



Fig. 2
A-0020.02



Fig. 3
A-0020.03



Fig. 4
A-0020.04



Fig. 5
A-0020.05



Fig. 6
A-0020.06



Fig. 7
A-0020.07



Fig. 8
A-0020.08



Fig. 9
A-0020.09



Fig. 10
A-0020.10

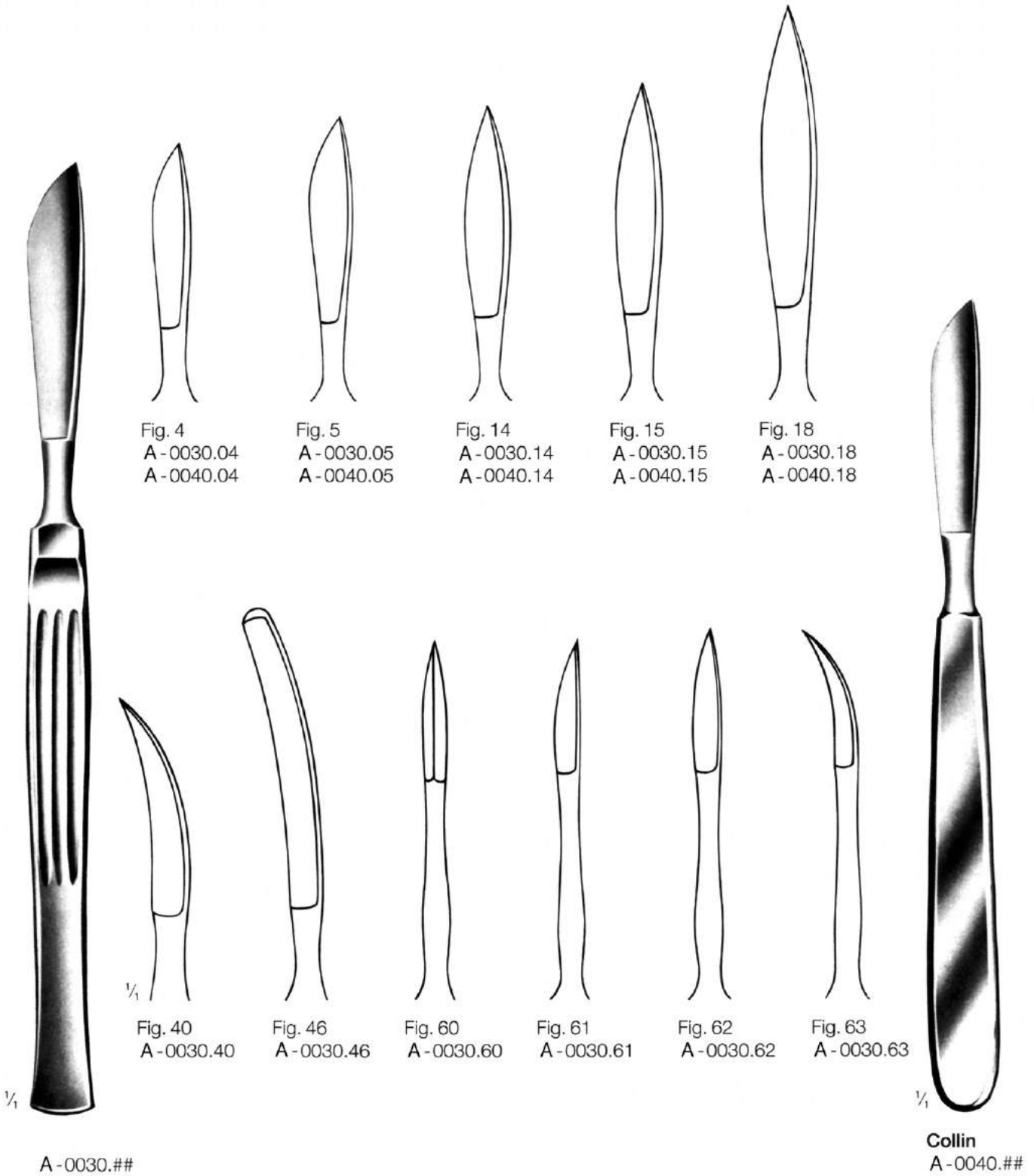



1/4

Dieffenbach



Fig. 1
A-0056.01



Fig. 2
A-0056.02



Fig. 3
A-0056.03



Fig. 4
A-0056.04



Fig. 5
A-0056.05



1/4
Fig. 6
A-0056.06



Fig. 7
A-0056.07



Fig. 8
A-0056.08



Fig. 9
A-0056.09

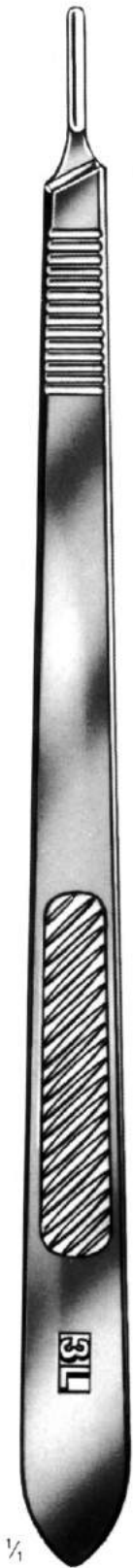

Fig. 15
A-0056.15



Fig. 16
A-0056.16

for blades
 A-0105.10 A-0106.15



No. 3L
 A-0100.13



No. 3
 A-0100.03



No. 7
 A-0100.17



No. 7K
 A-0100.07

for blades
 A-0112.18 – A-0113.36

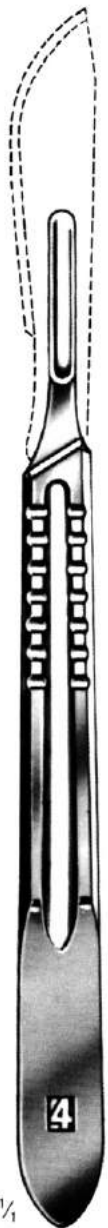

No. 4
 A-0102.04

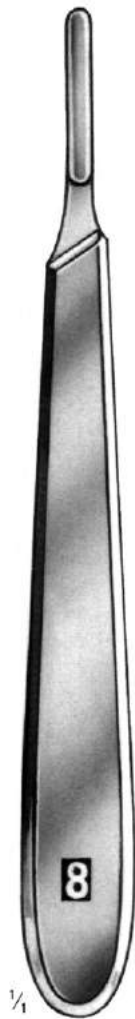

No. 8H
 A-0102.08



No. 4L
 A-0102.14



Kling-Ex
 A-0108.05

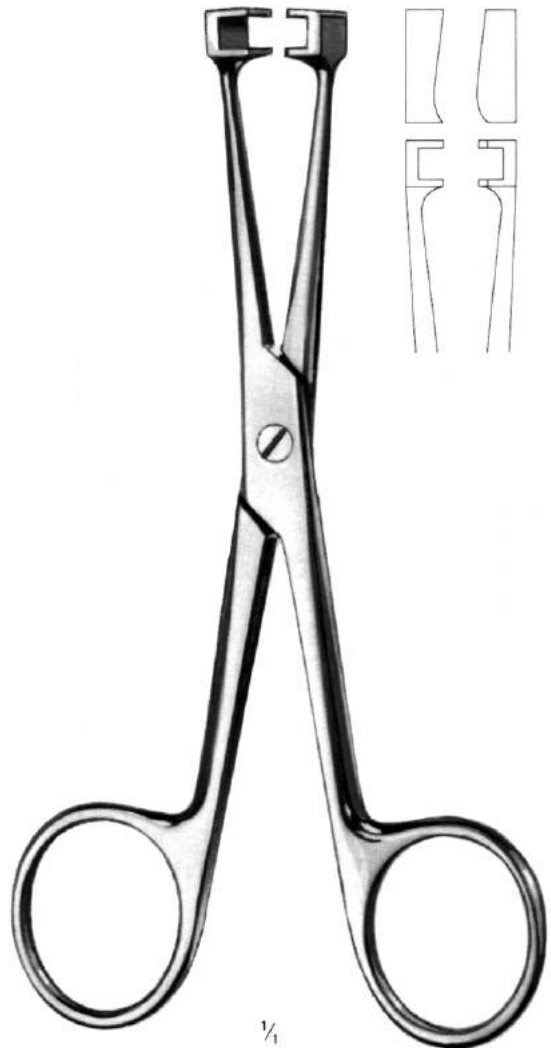

Dutch Pattern
 14 cm, 5 1/2"
 A-0108.14

for handles
A-0100.03, A-0100.07
A-0100.13, A-0100.17

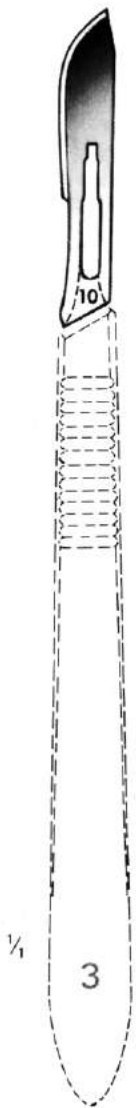

Fig.	10	11	12	13	14
steril	A-0105.10	A-0105.11	A-0105.12	A-0105.13	A-0105.14



Fig.	15	16	17	12d	15c
steril	A-0105.15	A-0105.16	A-0105.17	A-0106.12	A-0106.15

for handles
A-0102.04 – A-0102.14

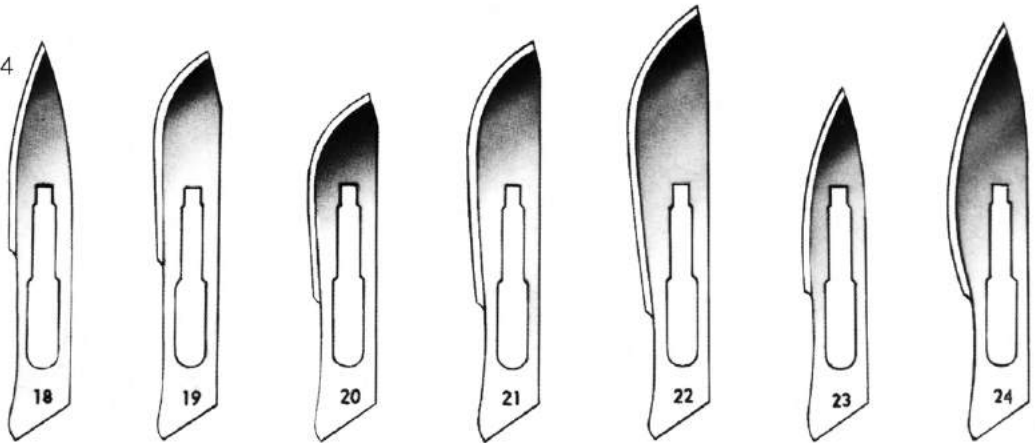
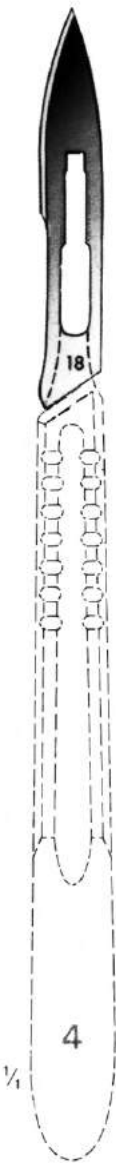

Fig.	18	19	20	21	22	23	24
steril	A-0112.18	A-0112.19	A-0112.20	A-0112.21	A-0112.22	A-0112.23	A-0112.24

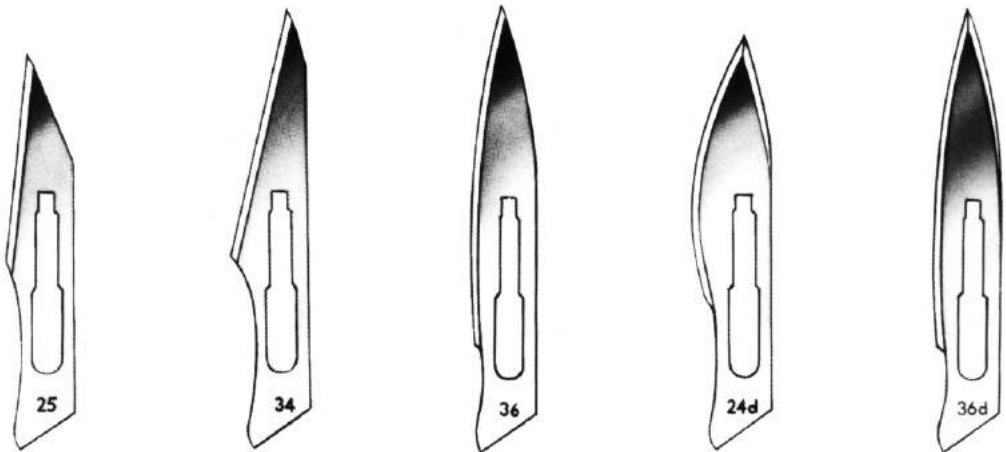
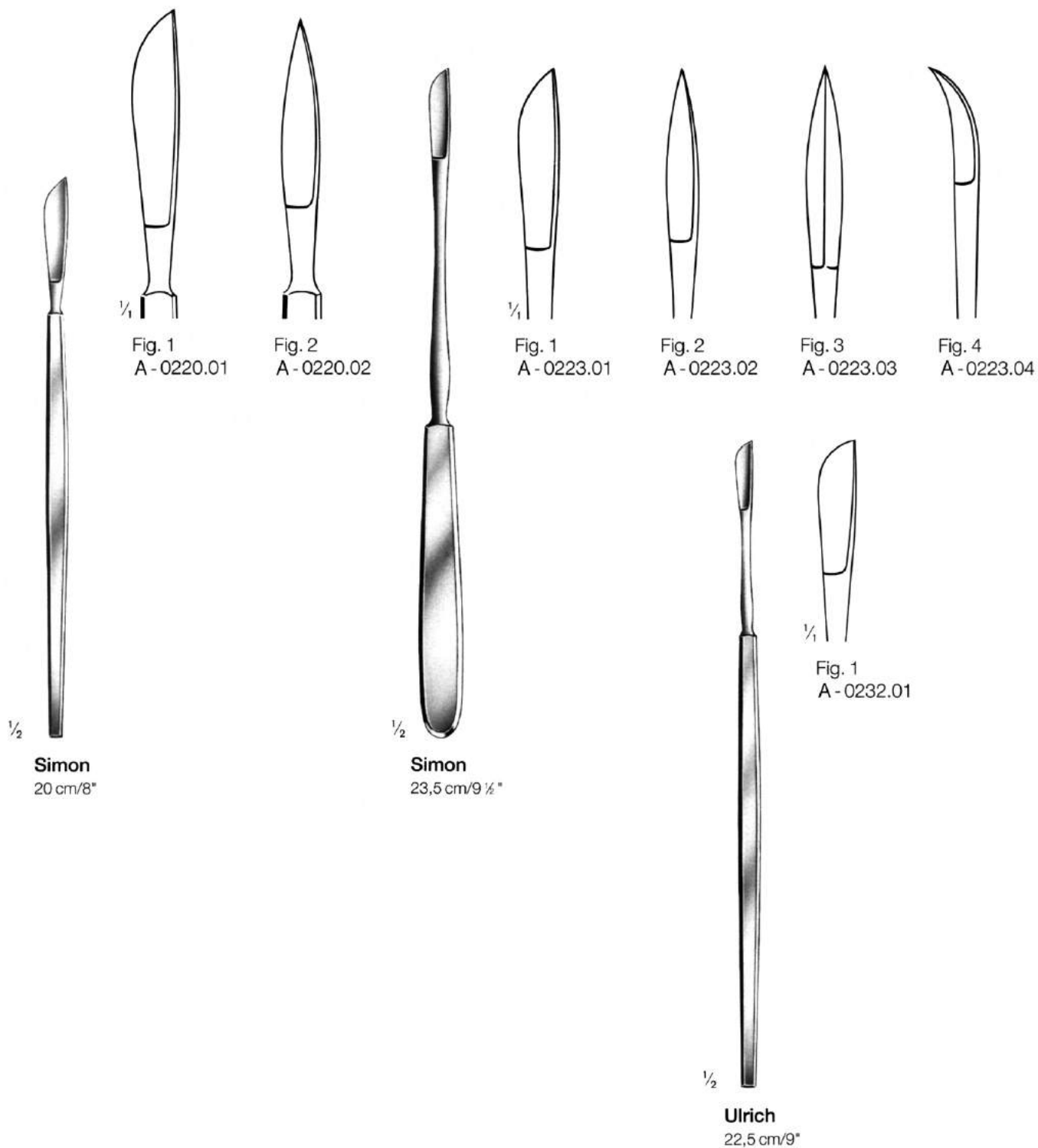
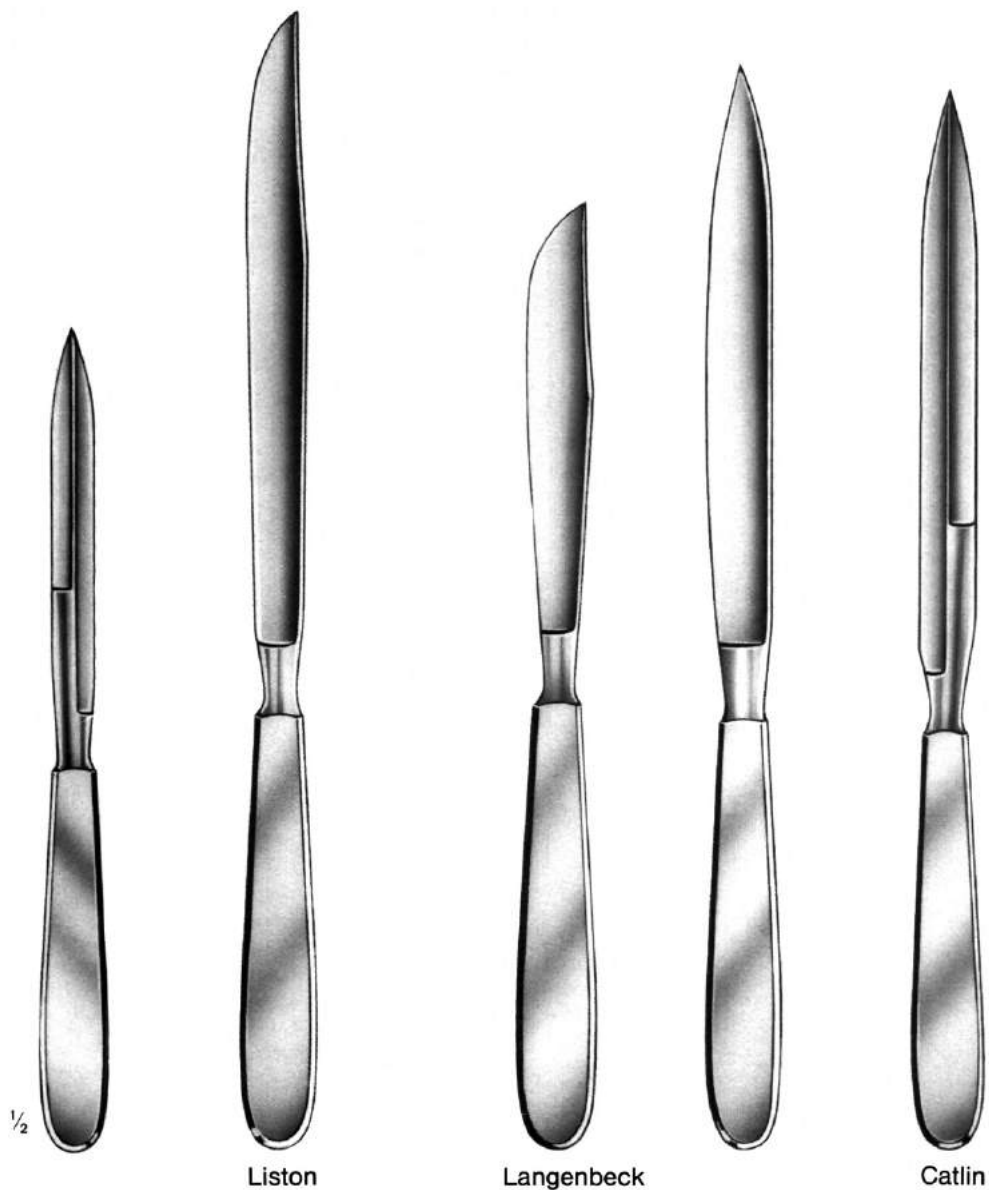

Fig.	25	34	36	24d	36d
steril	A-0112.25	A-0112.34	A-0112.36	A-0113.24	A-0113.36





Length of cut

cm	inch.			
11	4 $\frac{1}{2}$	A - 0300.11		
12	4 $\frac{3}{4}$		A - 0316.12	
13	5		A - 0316.13	A - 0318.13
16	6 $\frac{1}{4}$			A - 0318.16
17	6 $\frac{3}{4}$	A - 0310.17		A - 0320.16
19	7 $\frac{1}{2}$			A - 0318.19
20	8	A - 0310.20		A - 0320.19
22	8 $\frac{3}{4}$			A - 0318.22
				A - 0320.22

Cartilage Knife



1/4

A - 0402.05

Resection Knives



1/4

Langenbeck
A - 0406.05



A - 0408.05

Transplantation Knives

Cone Knives

Myoma Knife



Thiersch
20 cm/8"
A-0331.20



Rehn
23 cm/9"
A-0336.23

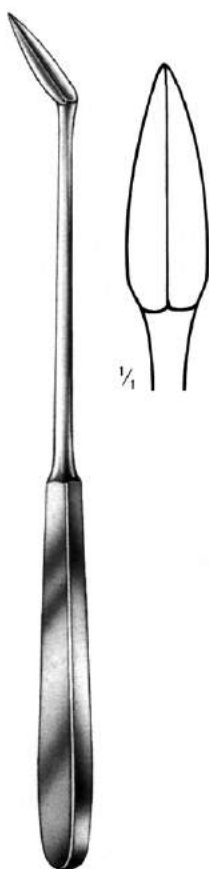

23 cm/9"
A-0361.23



Ayre
23.5 cm/9 1/4"
A-0361.24



Segond
27 cm/10 3/4"
A-0380.27

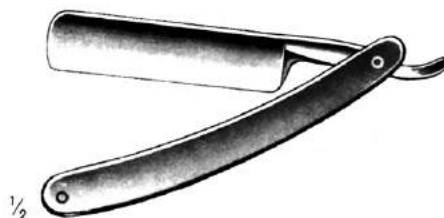

A-0340.06

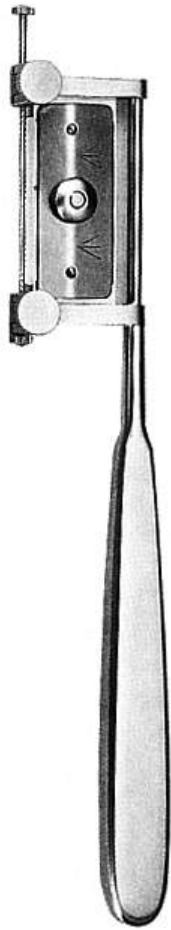

SILVER
19,0 cm, 7 1/2"
A-0020.19



SCHINK
30,0 cm, 12"
A-0022.30



A-0020.20
Spare blade



HUMBY
35,0 cm, 14"
A-0020.35

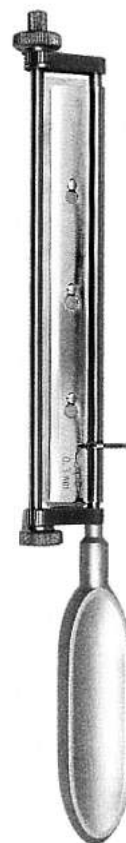

WATSON
30,0 cm, 12"
A-0020.30

Periosteal Knife



Muck
 13,5 cm/5 1/2"
 A - 2010.13

Mastoid Knife



Politzer
 13,5 cm/5 1/2"
 A - 2012.13



Brühl
 15 cm/6"
 A - 2020.15



Brühl
 15 cm/6"
 A - 2021.15

Furuncle Knife



Politzer
 16 cm/6 1/4"
 A - 2028.16

Tympanum Knives



Jacobson
 15,5 cm/6 1/4"
 A - 2030.15



Buck
 15 cm/6"
 A - 2032.15



Fig. 1
 Fig. 2



Fig. 1
 Fig. 2

Sexton

straight	Fig.	curved
A - 2040.01	1	A - 2041.01
A - 2040.02	2	A - 2041.02

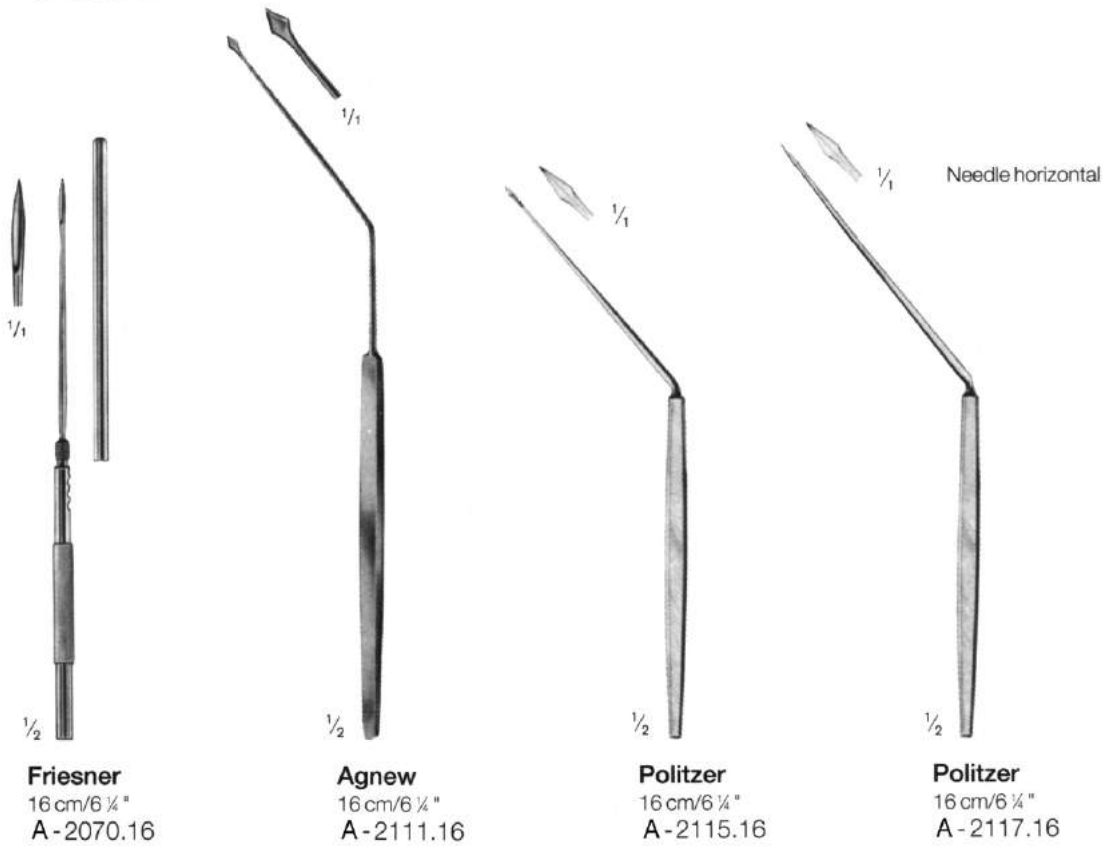
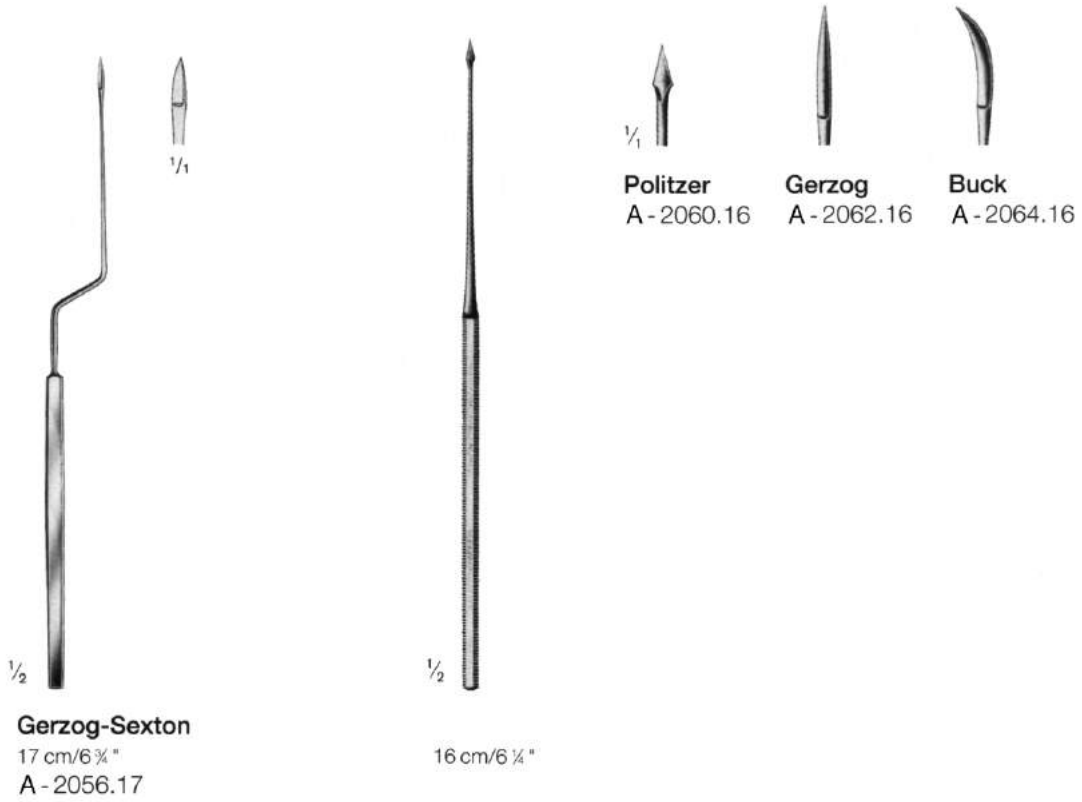



Lucae
 18 cm/7 1/4"
 A - 2125.18

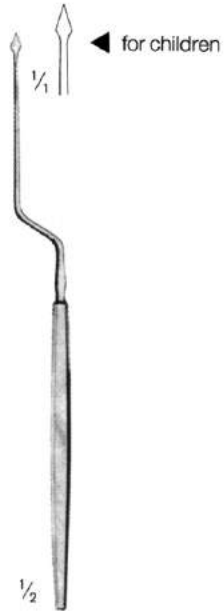

Lucae
 16 cm/6 1/4"
 A - 2127.16



Lucae
 18 cm/7 1/4"
 A - 2129.18



Bayer
 10 cm/4"
 A - 2135.10

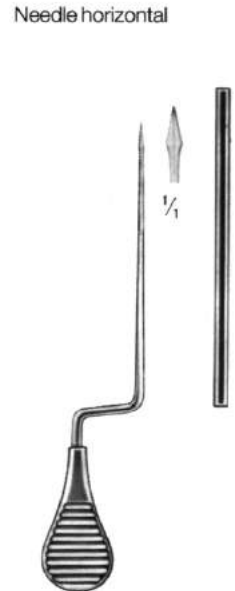

Bayer
 10 cm/4"
 A - 2137.10

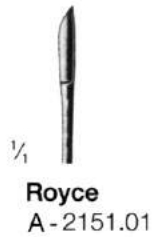

Royce
 A - 2151.01



Royce
 A - 2151.02



Sexton
 A - 2151.03



Politzer
 A - 2151.05

Handle only

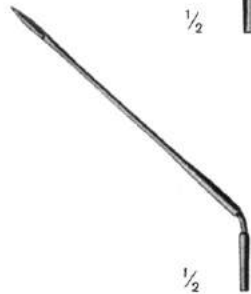

Royce
 A - 2150.00

Tip only



Royce
 A - 2153.11



Royce
 A - 2153.12



Sexton
 A - 2153.13



Politzer
 A - 2153.15

Rhinoplastic Knives

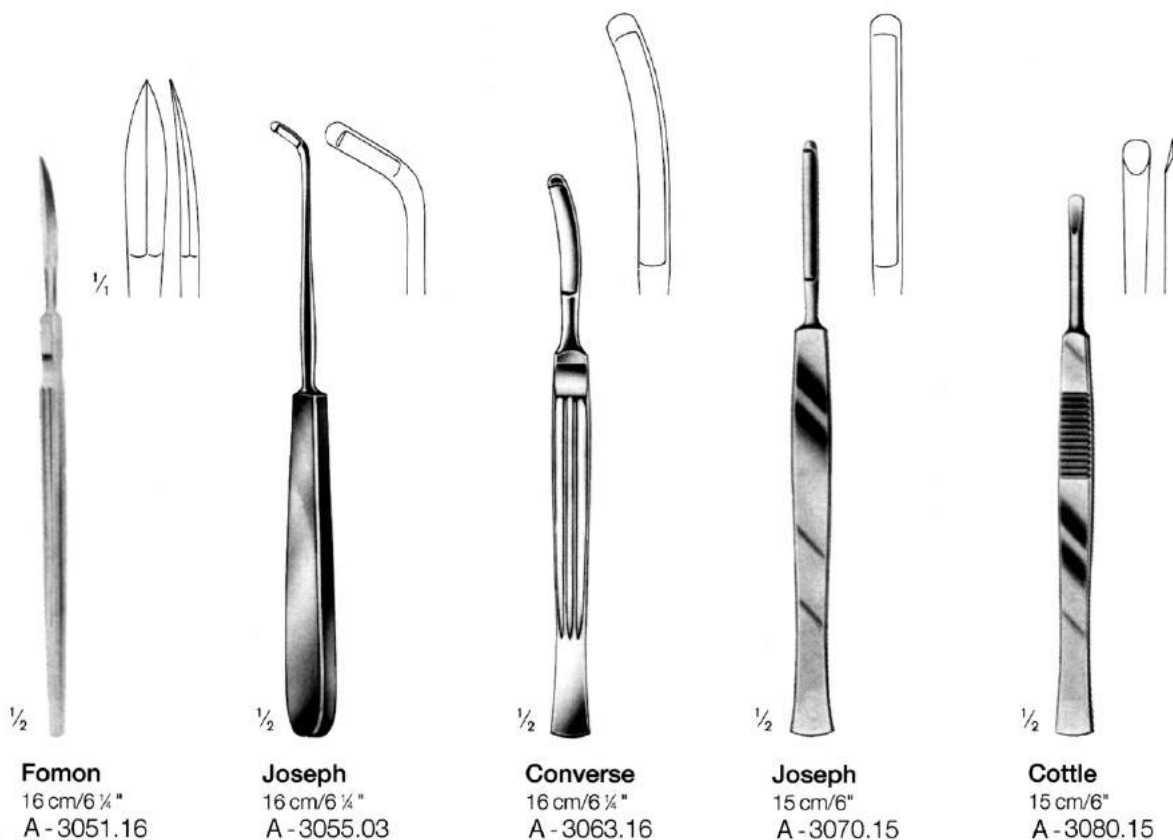
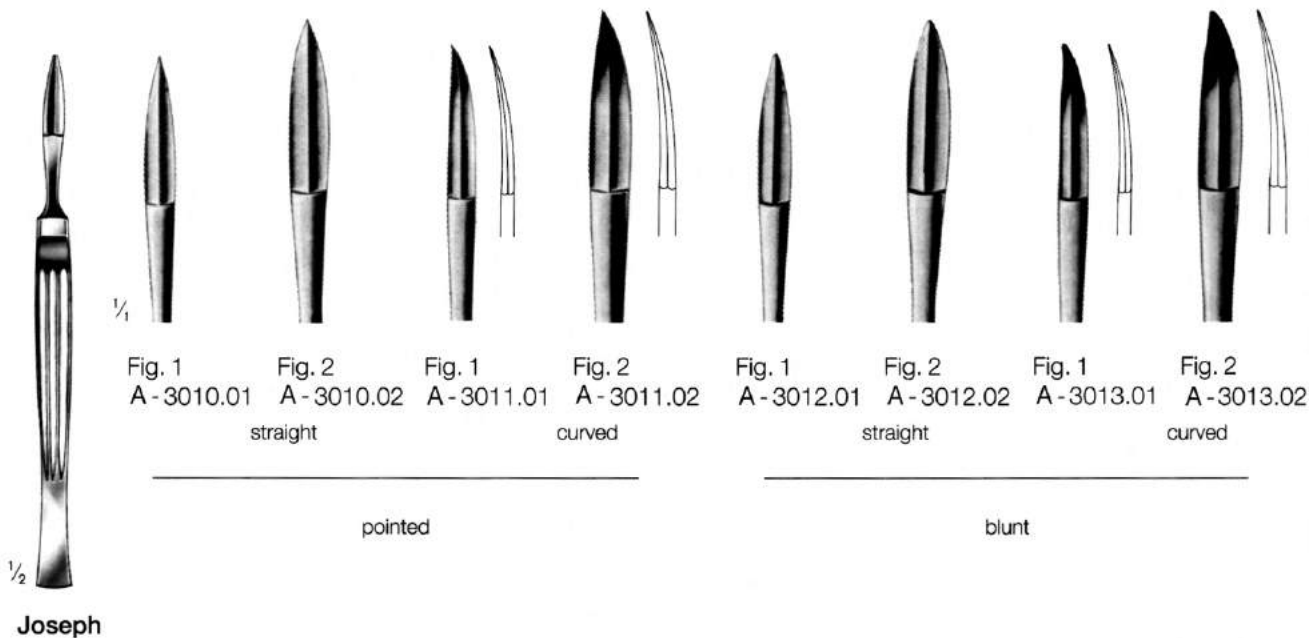

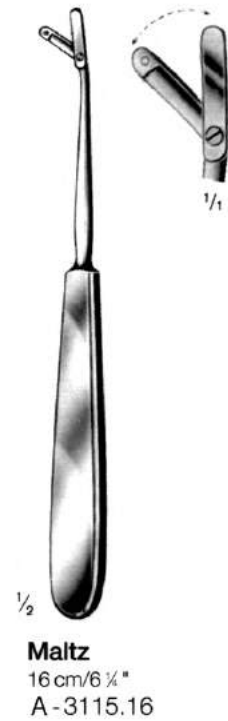
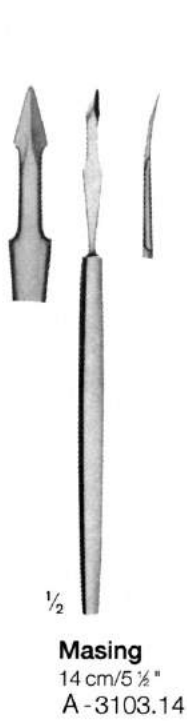
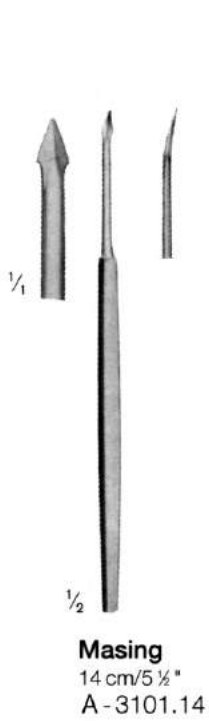

Cartilage Knife

Mucous Knives

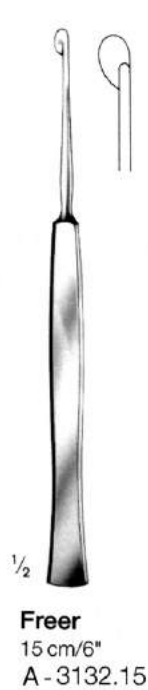

Septum knives
Bistouris pour la cloison nasale
Bisturías para el tabique nasal

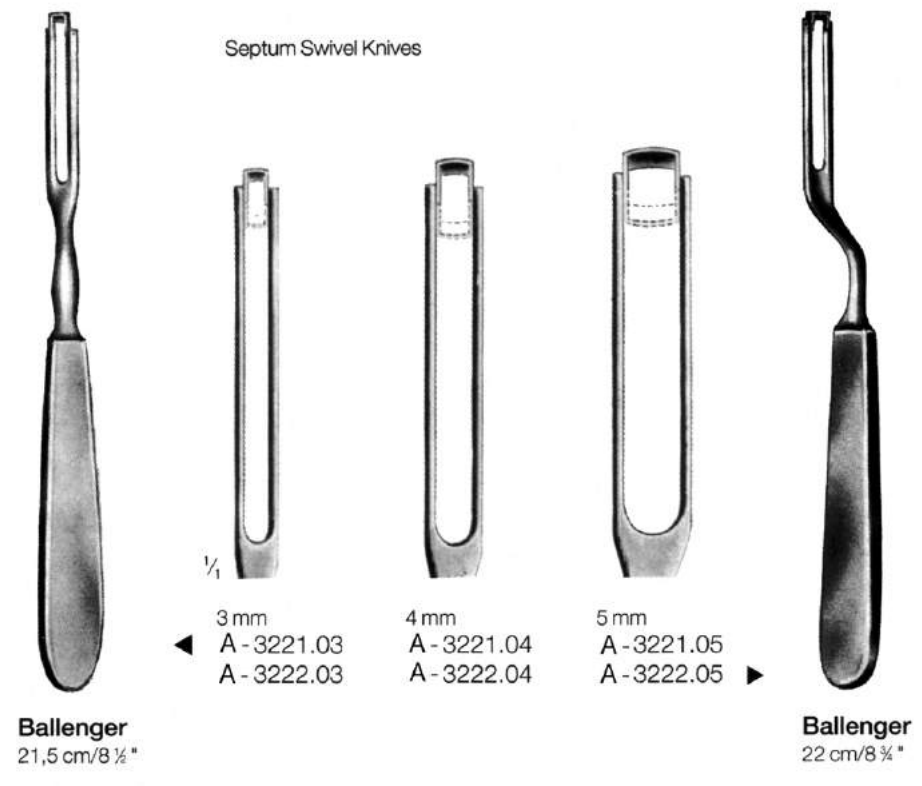

Dura knives



Tönnis



13,5 cm/5"
A-5010.13



19 cm/7 1/2"
A-5010.19



Halle
21 cm/8 1/4"
A-5020.21

Trigeminal knives



Olivecrona
20 cm/8"
A-5031.20



Olivecrona
23 cm/9"
A-5040.23



Canfield
 21 cm/8 1/4"
 A-4100.21



Dean
 19 cm/7 1/2"
 A-4130.19
 straight



Dean
 19 cm/7 1/2"
 A-4131.19
 angled

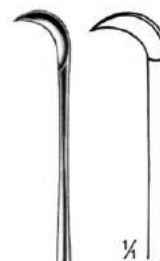

Bruenings
 23 cm/9"
 A-4150.23



Abraham
 21 cm/8 1/4"
 A-4156.21



Fisher
 22,5 cm/9"
 A-4163.22
 saw edge



Tyding
 21 cm/8 1/4"
 A-4171.21



Day
 21,5 cm/8 1/2"
 A-4175.21

also available in 19 cm/7 1/2"

6 mm



Smillie
 17 cm/6 3/4"
 A-6017.01



Smillie
 17 cm/6 3/4"
 A-6017.02



Smillie
 17 cm/6 3/4"
 A-6017.03



Smillie
 17 cm/6 3/4"
 A-6017.04



Smillie
 17 cm/6 3/4"
 A-6017.05

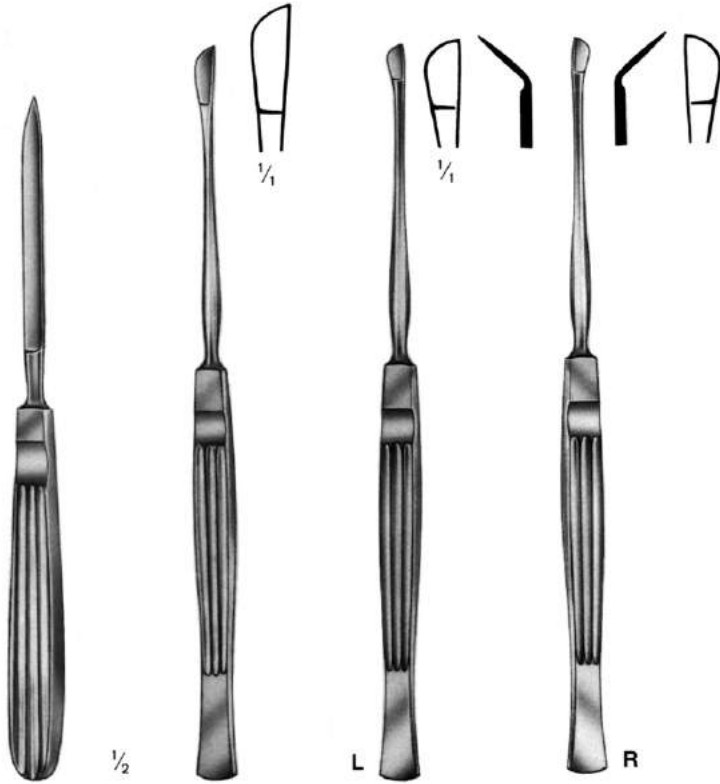

DePalma style
18 cm/7"
A-6178.18

Downing (Semi-Lunar Cartilage)
22 cm/8 3/4"
A-6172.01 A-6172.02 A-6172.03

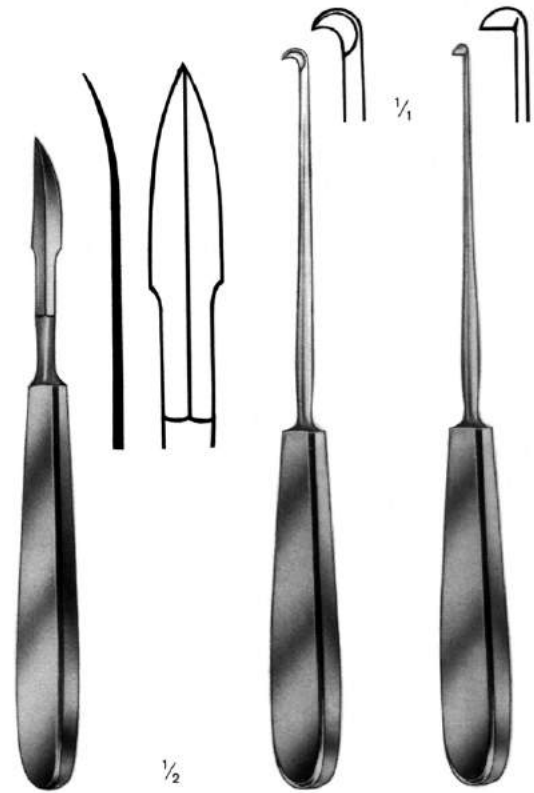

18 cm/7"
A-6045.18

Bircher
20 cm/8"
A-6139.02

Bircher
20 cm/8"
A-6139.05



18 cm/7"
A - 6078.01

1/4



18 cm/7"
A - 6078.02

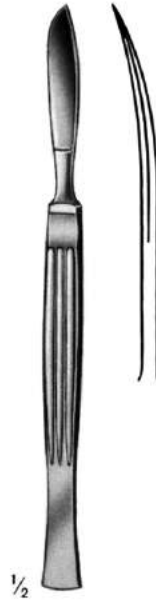

16 cm/6 3/4"
A - 6086.01

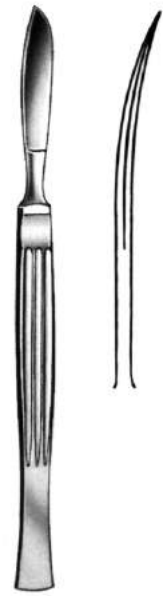

16 cm/6 3/4"
A - 6086.02



A - 6122.01
curved to the left



A - 6122.02
curved to the right

Neff
22 cm/8 3/4"

1/2



1/4



1/4



1/2

A - 6128.02

right



A - 6128.01

left

Mendler
18 cm/7"

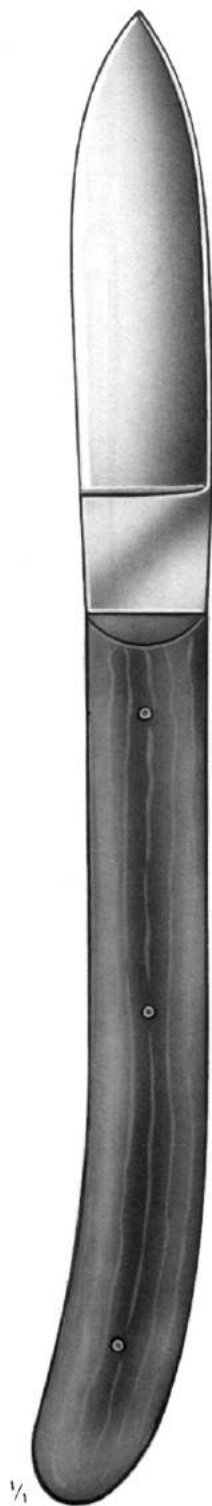

$\frac{1}{4}$
Hopkins
20 cm/8"
A-6510.20



$\frac{1}{4}$
Reiner
18,5 cm/7 $\frac{1}{4}$ "
A-6515.18



$\frac{1}{4}$
Esmarch
18 cm/7"
A-6518.18



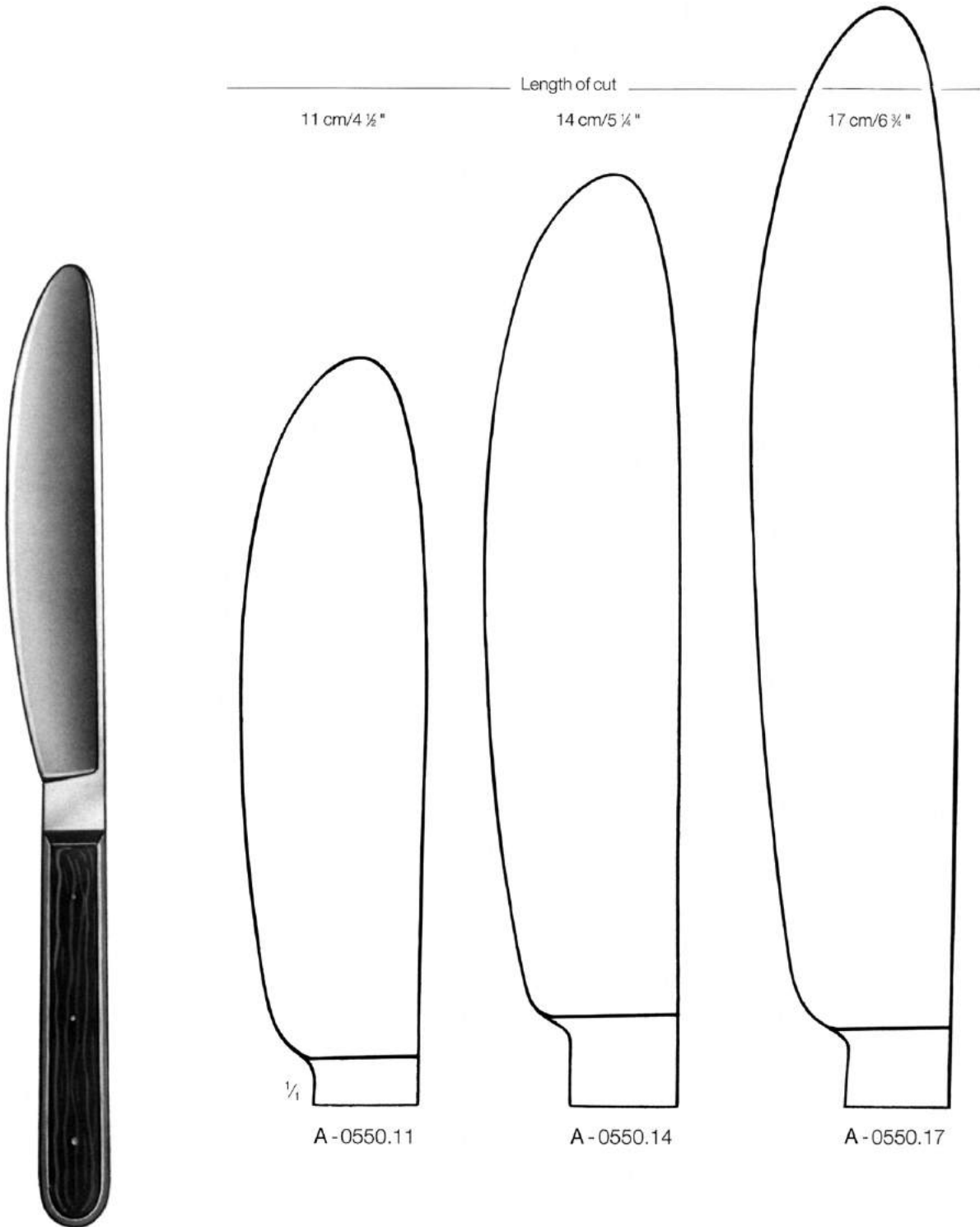

Wooden handle



Virchow

Metal handle

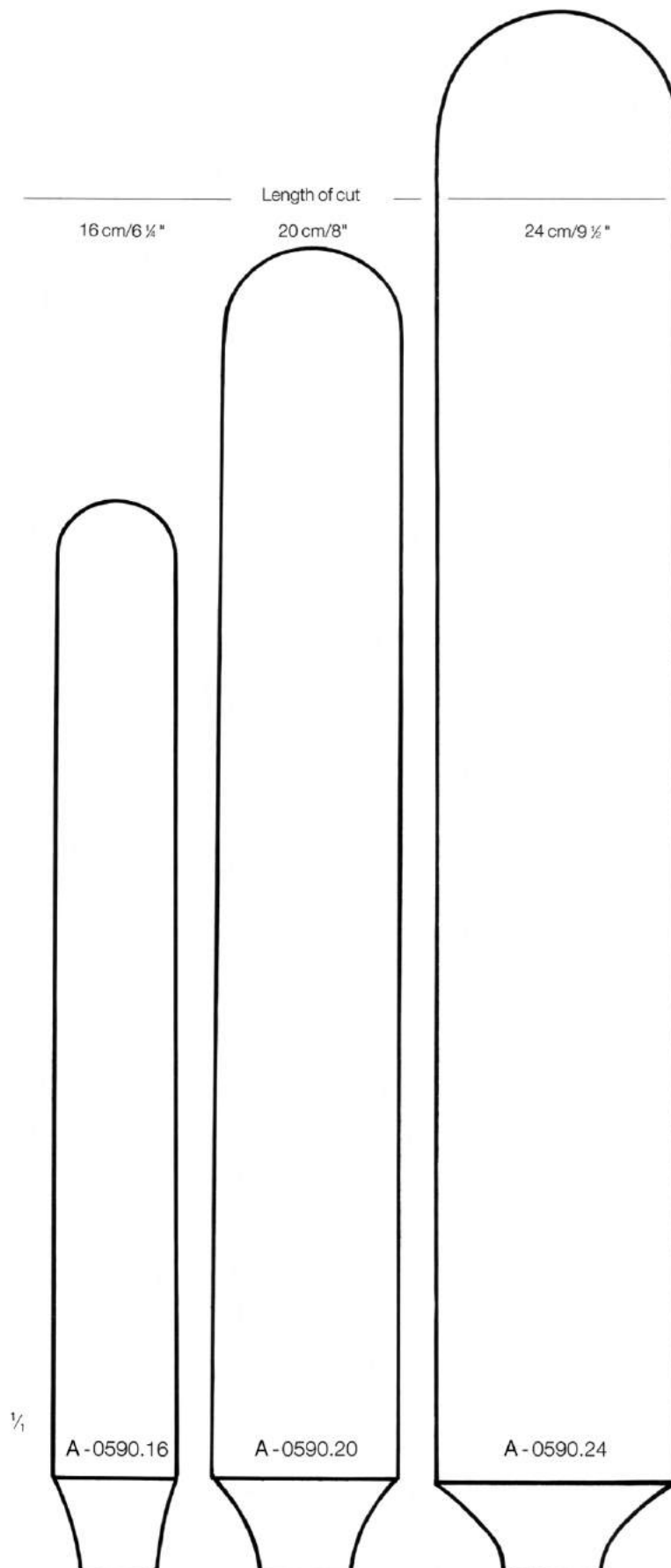



Troutman-Chris
 Ø 5,5 mm
 9 cm/3 1/2"
 A - 6710.09

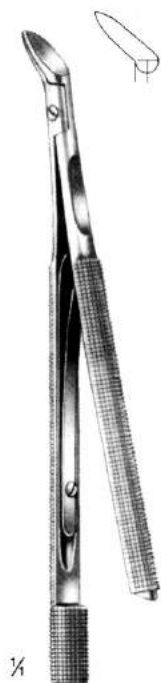

Troutman-Chris
 Ø 5,5 mm
 9 cm/3 1/2"
 A - 6711.09

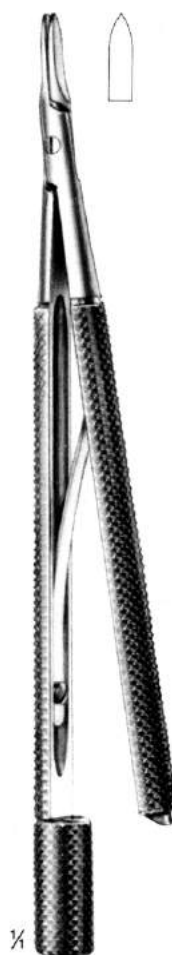

Castroviejo
 Ø 8 mm
 13 cm/5"
 A - 6728.13



Barraquer
 11 cm/4 1/4"
 A - 6734.11



Castroviejo
 Ø 6 mm
 9 cm/3 1/2"
 A-6746.09



Castroviejo
 Ø 6 mm
 12 cm/4 3/4"
 A-6756.12



Castroviejo
 Ø 6 mm
 18 cm/7"
 A-6766.18



Package of 10 blades

A-6790.10



B

- Probes, Spatulas, cotton carriers, suction tube and trocars
- Sondes, spatules, porte-cotons, canules aspiratriees, trocars
- Sondas, espátulas, portaalgodones, cánulas de aspiración, trócares

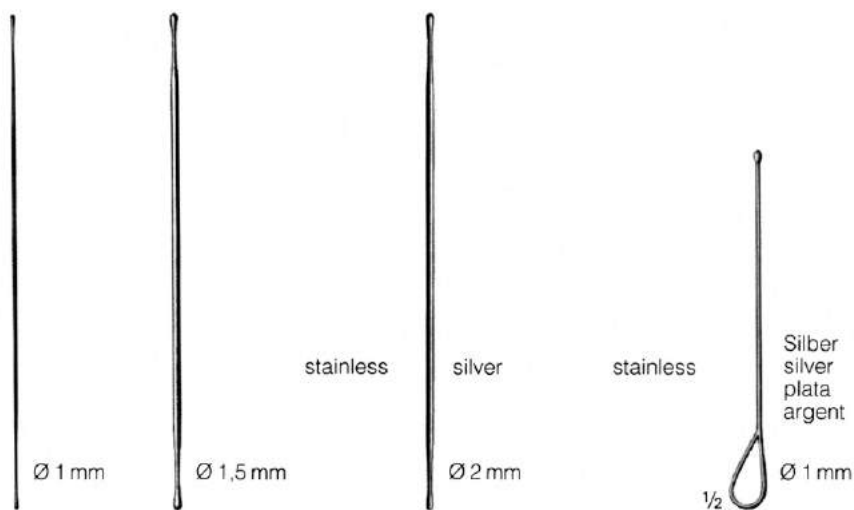

cm	in.						
11,5	4 ½	B-0010.11	B-0015.11	B-0020.11	B-0021.11	B-0081.11	B-0082.11
13	5	B-0010.13	B-0015.13	B-0020.13	B-0021.13		
14,5	5 ¾	B-0010.14	B-0015.14	B-0020.14	B-0021.14		
16	6 ¼	B-0010.16	B-0015.16	B-0020.16	B-0021.16		
18	7	B-0010.18	B-0015.18	B-0020.18	B-0021.18		
20	8	B-0010.20	B-0015.20	B-0020.20	B-0021.20		
25	10	B-0010.25	B-0015.25	B-0020.25	B-0021.25		

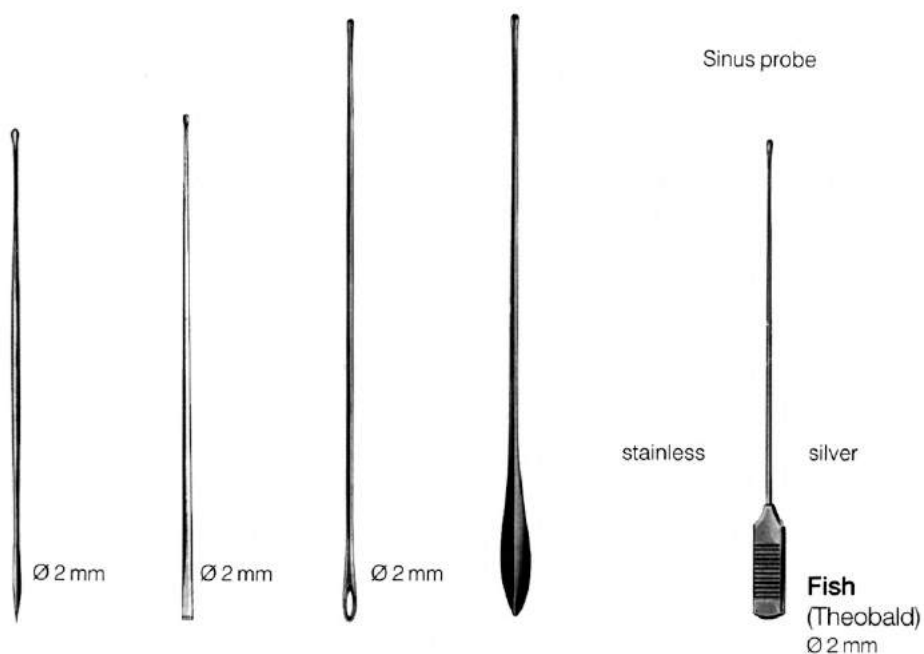

cm	in.						
10,5	4 ¼				B-0065.10		
11,5	4 ½			B-0052.11			
13	5	B-0032.13	B-0042.13	B-0052.13	B-0065.13		
14,5	5 ¾	B-0032.14	B-0042.14	B-0052.14	B-0065.14	B-0072.14	B-0073.14
16	6 ¼	B-0032.16	B-0042.16	B-0052.16	B-0065.16		
18	7	B-0032.18		B-0052.18		B-0072.18	
20	8	B-0032.20		B-0052.20	B-0065.20		
25	10	B-0032.25		B-0052.25			

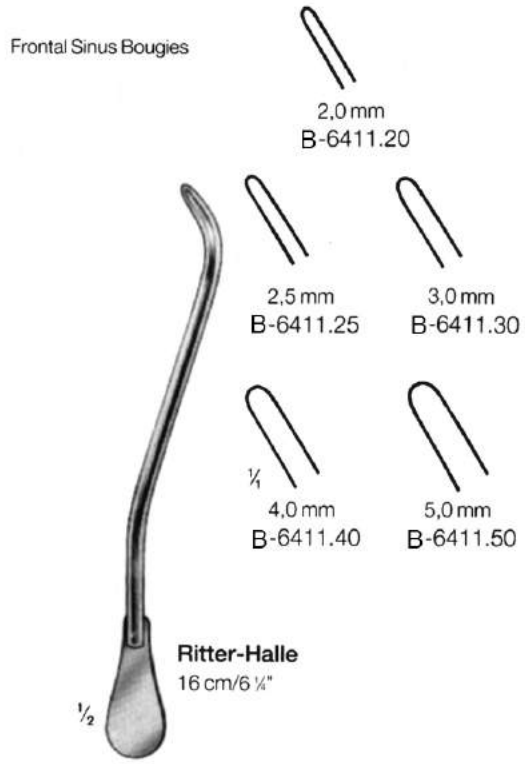

cm	in.				
10,5	4 1/4	B-0100.11	B-0110.11		
13	5	B-0100.13	B-0110.13		B-0502.13
14,5	5 3/4	B-0100.14	B-0110.14	B-0101.14	B-0502.14
16	6 1/4	B-0100.16	B-0110.16		B-0120.16
18	7	B-0100.18	B-0110.18		
20	8	B-0100.20	B-0110.20		

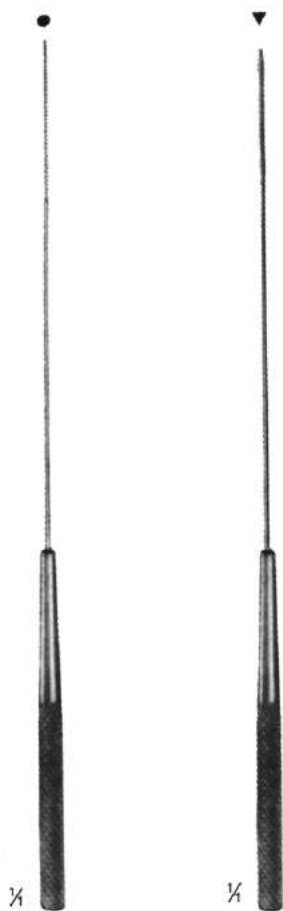

Piccolo – 0,8 mm
 11 cm / 4 1/2"
 B-0631.08

Piccolo – 0,8 mm
 11 cm / 4 1/2"
 B-0632.08



Liebermann – 1,5 mm
 14 cm / 5 1/2"
 B-0642.14



Universal

cm	in.	Ø1,5 mm	Ø1,5 mm
12	4 3/4	B-0655.12	B-0656.12
14	5 1/2	B-0655.14	B-0656.14
16	6 1/4	B-0655.16	B-0656.16
18	7	B-0655.18	B-0656.18
23	9	B-0655.23	B-0656.23



Farrell

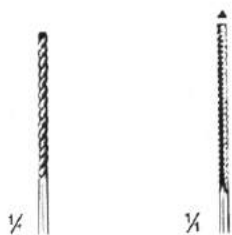

cm	in.	Ø1,2 mm	Ø1,2 mm
12	4 3/4	B-0712.12	B-0732.12
14	5 1/2	B-0712.14	B-0732.14
16	6 1/4	B-0712.16	B-0732.16
18	7	B-0712.18	B-0732.18
23	9	B-0712.23	B-0732.23

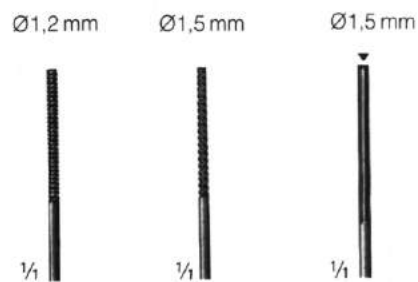

cm	in.	Ø1,2 mm	Ø1,5 mm	Ø1,5 mm
12	4 3/4	B-0812.12	B-0815.12	B-0816.12
14	5 1/2	B-0812.14	B-0815.14	B-0816.14
16	6 1/4	B-0812.16	B-0815.16	B-0816.16
18	7	B-0812.18	B-0815.18	B-0816.18

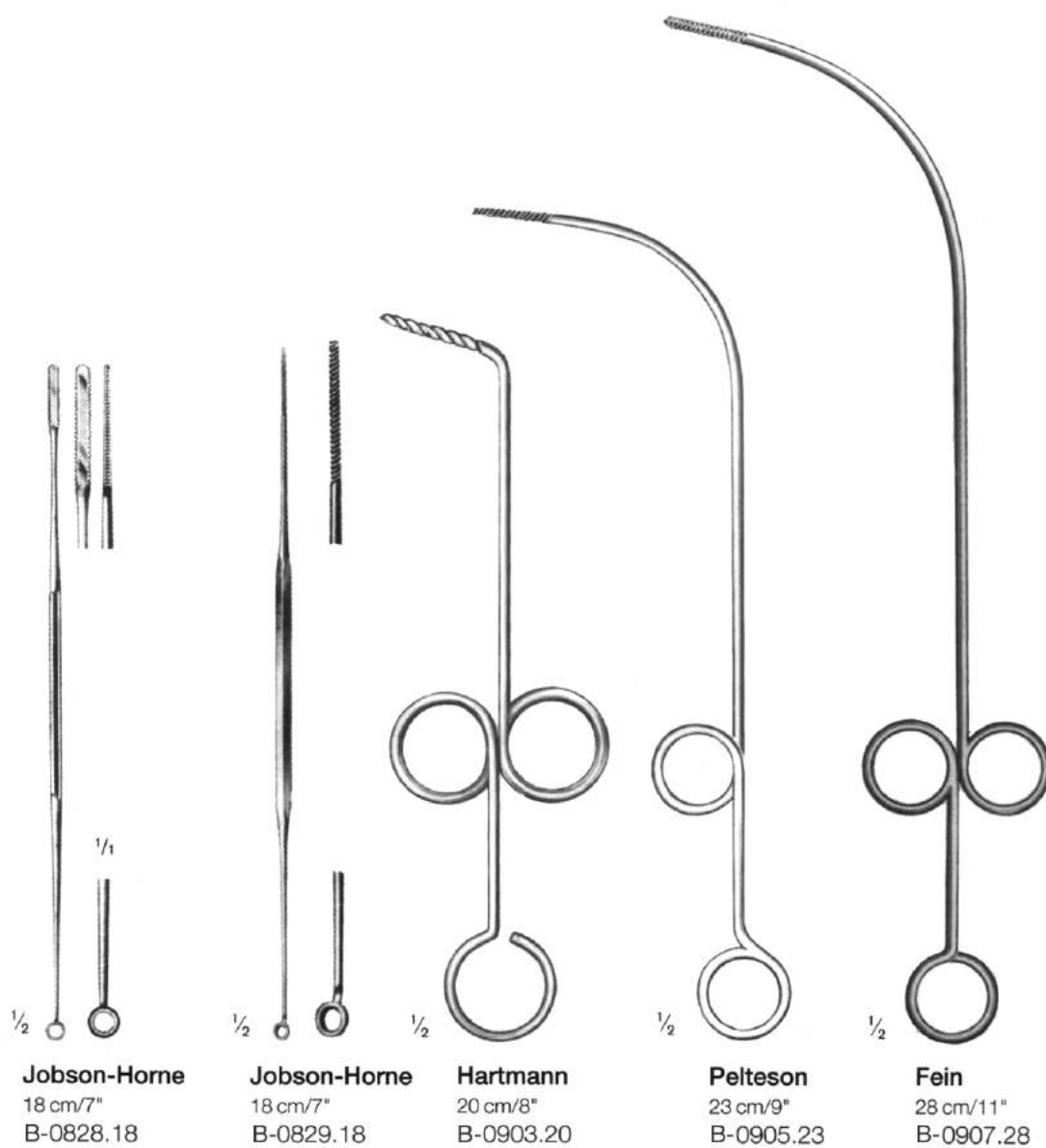

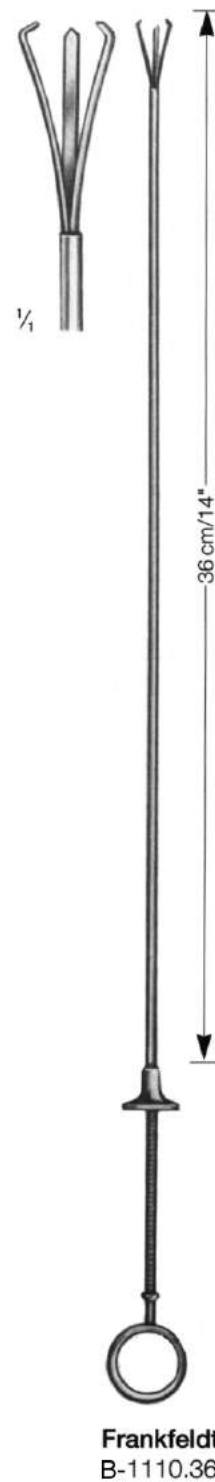
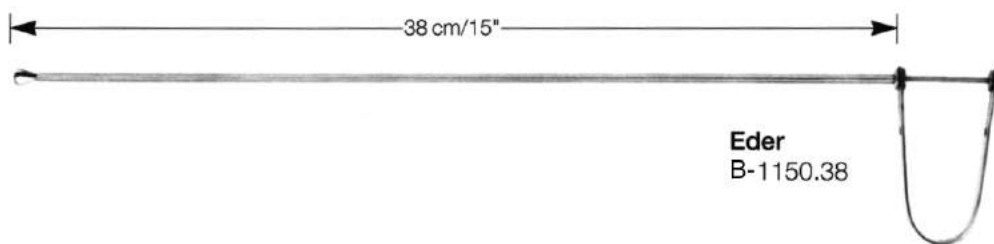
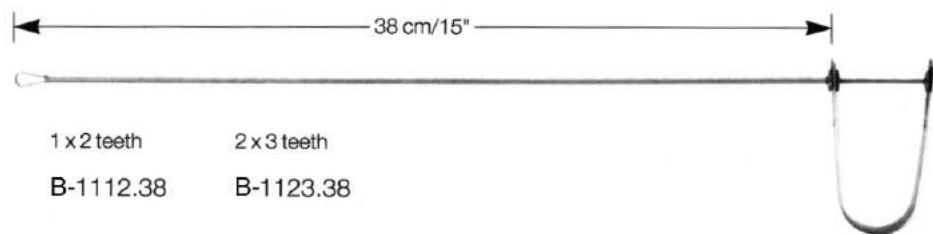

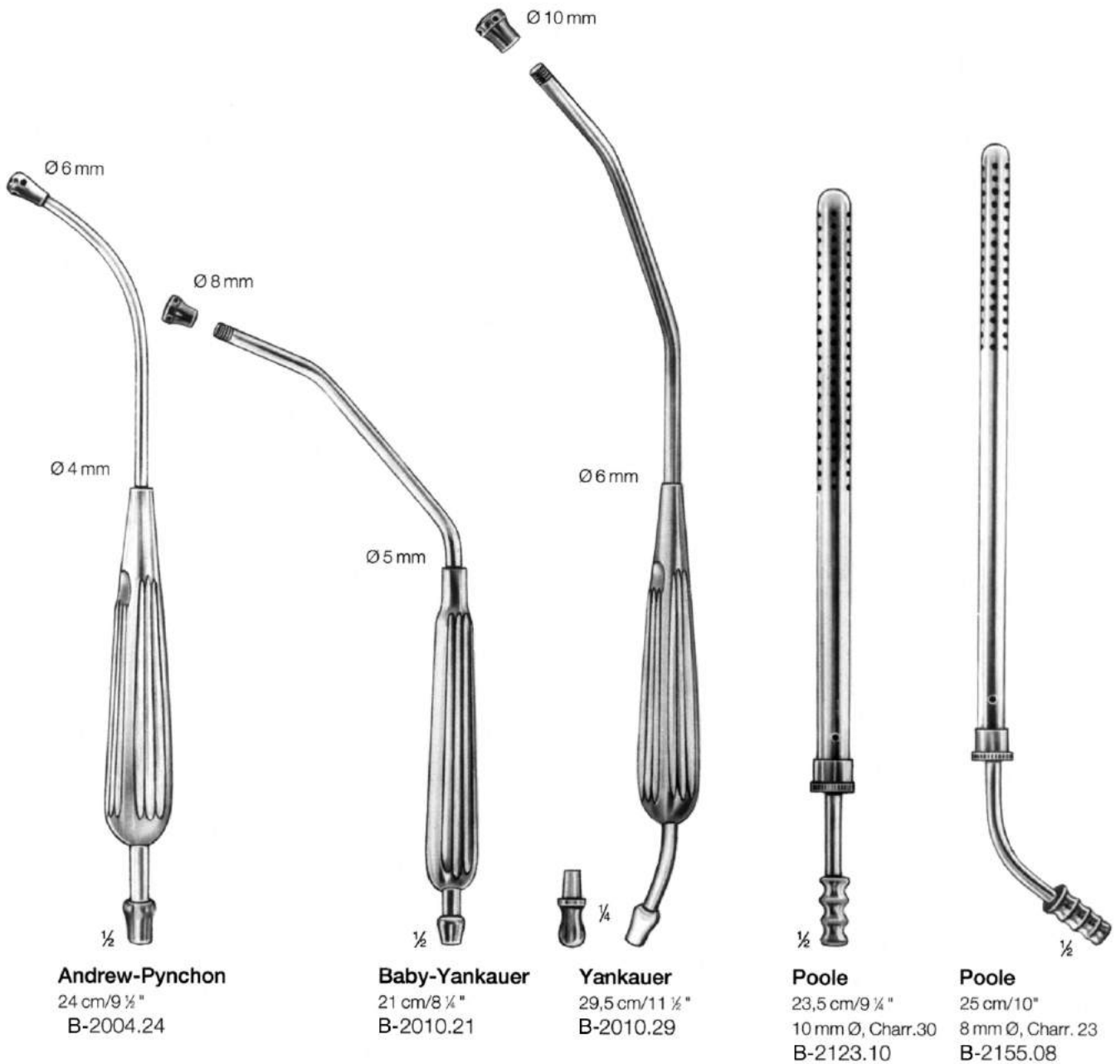
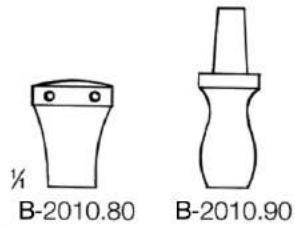

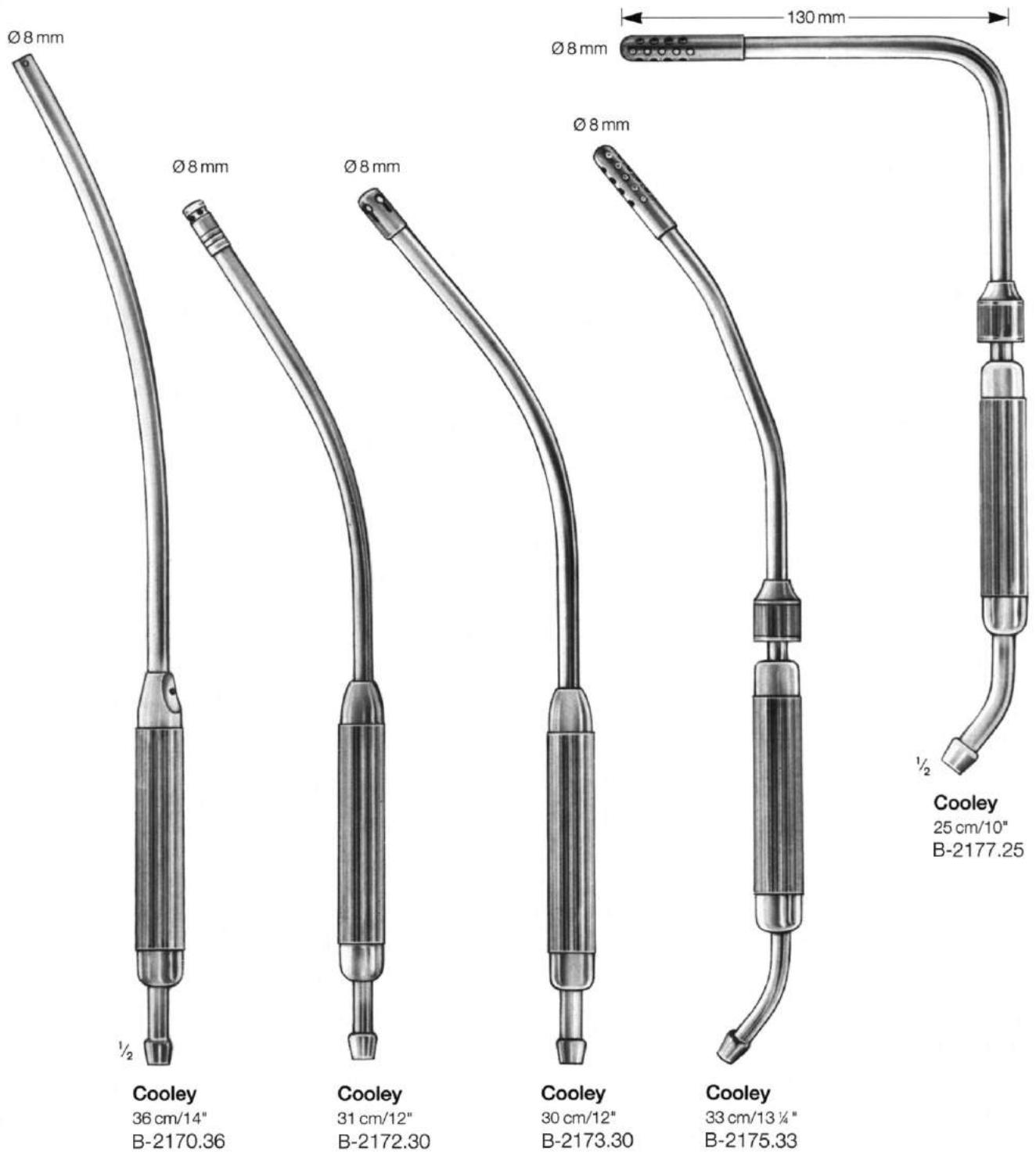

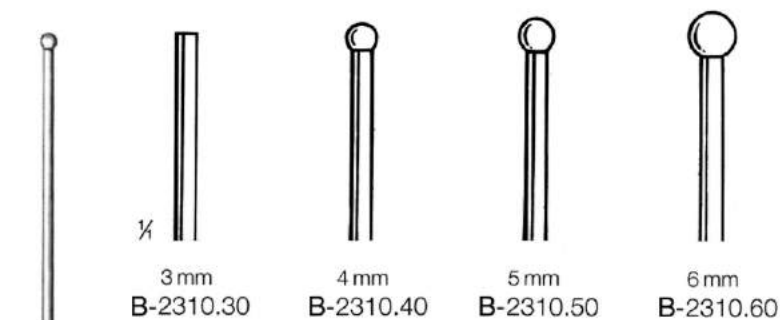

Vessel irrigating cannulas, malleable, silver plated

$\frac{1}{2}$

Schmid LLA
15 cm/6"



Adson Charr. 12
21 cm/8 $\frac{1}{4}$ " , 4 mm \varnothing
B-2344.40



Adson Charr. 12
21 cm/8 $\frac{1}{4}$ " , 4 mm \varnothing
B-2345.40

13 cm/5"
B-2353.20 = 2,0 mm \varnothing
B-2353.27 = 2,7 mm \varnothing
B-2353.33 = 3,3 mm \varnothing
B-2353.40 = 4,0 mm \varnothing

17 cm/6 $\frac{3}{4}$ "
B-2357.20 = 2,0 mm \varnothing
B-2357.27 = 2,7 mm \varnothing
B-2357.33 = 3,3 mm \varnothing
B-2357.40 = 4,0 mm \varnothing



Frazier

13 cm/5"
B-2363.20 = 2,0 mm \varnothing
B-2363.27 = 2,7 mm \varnothing
B-2363.33 = 3,3 mm \varnothing
B-2363.40 = 4,0 mm \varnothing

17 cm/6 $\frac{3}{4}$ "
B-2367.20 = 2,0 mm \varnothing
B-2367.27 = 2,7 mm \varnothing
B-2367.33 = 3,3 mm \varnothing
B-2367.40 = 4,0 mm \varnothing



Frazier

13 cm/5"
B-2373.20 = 2,0 mm \varnothing
B-2373.27 = 2,7 mm \varnothing
B-2373.33 = 3,3 mm \varnothing
B-2373.40 = 4,0 mm \varnothing

17 cm/6 $\frac{3}{4}$ "
B-2377.20 = 2,0 mm \varnothing
B-2377.27 = 2,7 mm \varnothing
B-2377.33 = 3,3 mm \varnothing
B-2377.40 = 4,0 mm \varnothing



Fergusson

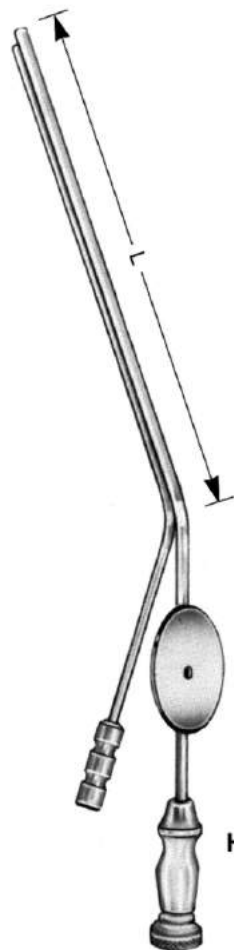

L = 9 cm/3 1/2"

L = 18 cm/7"

Suction tube		Irrigation tube		Suction tube		Irrigation tube	
mm Ø		mmØ		mm Ø		mmØ	
0,9	x	0,7	B-2409.09				
1,2	x	0,9	B-2409.12				
1,5	x	1,2	B-2409.15				
1,8	x	1,8	B-2409.18	1,8	x	1,8	B-2418.18
2,5	x	2,0	B-2409.25	2,5	x	2,0	B-2418.25
3,0	x	2,0	B-2409.30	3,0	x	2,0	B-2418.30
4,5	x	2,0	B-2409.45				

House-Luer

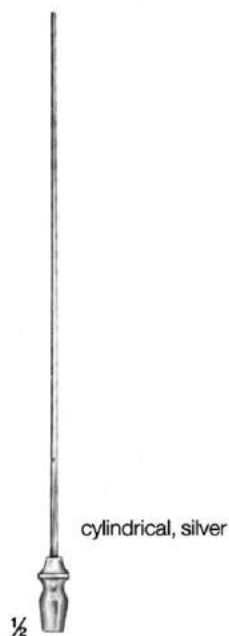

Wullstein
 16 cm/6 1/4"
 B-2502.15 Ø 1,5 mm
 B-2502.20 Ø 2,0 mm

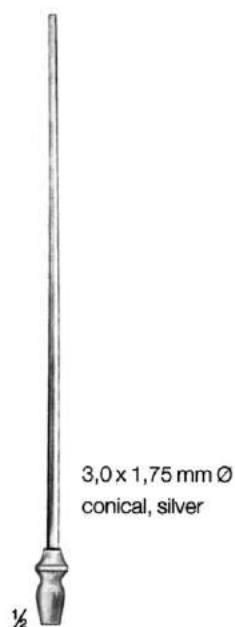

Wullstein
 16 cm/6 1/4"
 B-2506.30



Wullstein
 10,5 cm/4 1/4"
 B-2510.50

Handle with thumb valve for Wullstein suction tubes



NEGUS
 6 mm
 B - 2512.60
 210 mm, 8 1/4"
 Suction dissector



B-2425.20

Suction Adaptor with Luer tip and thumb valve

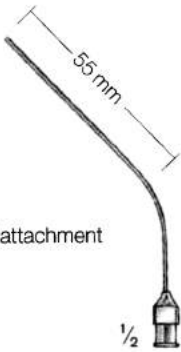

with LUER-LOCK attachment

Rosen
1/2

- Ø 0,5 mm **B-2431.05**
- Ø 0,6 mm **B-2431.06**
- Ø 0,7 mm **B-2431.07**
- Ø 0,8 mm **B-2431.08**
- Ø 0,9 mm **B-2431.09**
- Ø 1,0 mm **B-2431.10**
- Ø 1,2 mm **B-2431.12**
- Ø 1,4 mm **B-2431.14**
- Ø 1,5 mm **B-2431.15**
- Ø 1,8 mm **B-2431.18**
- Ø 2,0 mm **B-2431.20**
- Ø 2,5 mm **B-2431.25**
- Ø 3,0 mm **B-2431.30**

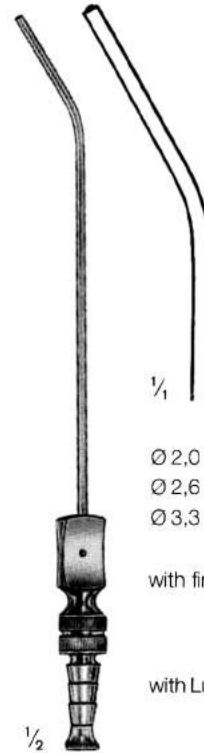

1/4

- Ø 2,0 mm = Charr. 6 **B-2461.06**
- Ø 2,6 mm = Charr. 8 **B-2461.08**
- Ø 3,3 mm = Charr. 10 **B-2461.10**

with finger cut-off

with Luer cone

Plester
19 cm/7 1/2"

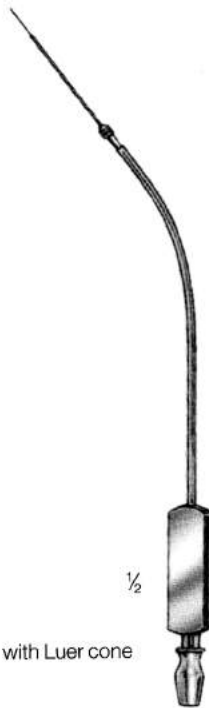

with Luer cone

Zöllner
18,5 cm/7 1/4"
B-2453.07

with detachable fine suction tip Ø 0,7 mm

15 cm/6"
B-2453.66

Aspirating Tube only
(without cannula)



Zöllner
B-2453.75 Ø 0,5 mm
B-2453.77 Ø 0,7 mm

Micro Suction Cannula only, for Suction Tube, working length 30 mm



1/2

Baron (Schuknecht)

Ø charr. x L mm		
3	75	B-2437.03
5	75	B-2437.05
7	75	B-2437.07
3	100	B-2440.03
5	100	B-2440.05
7	100	B-2440.07

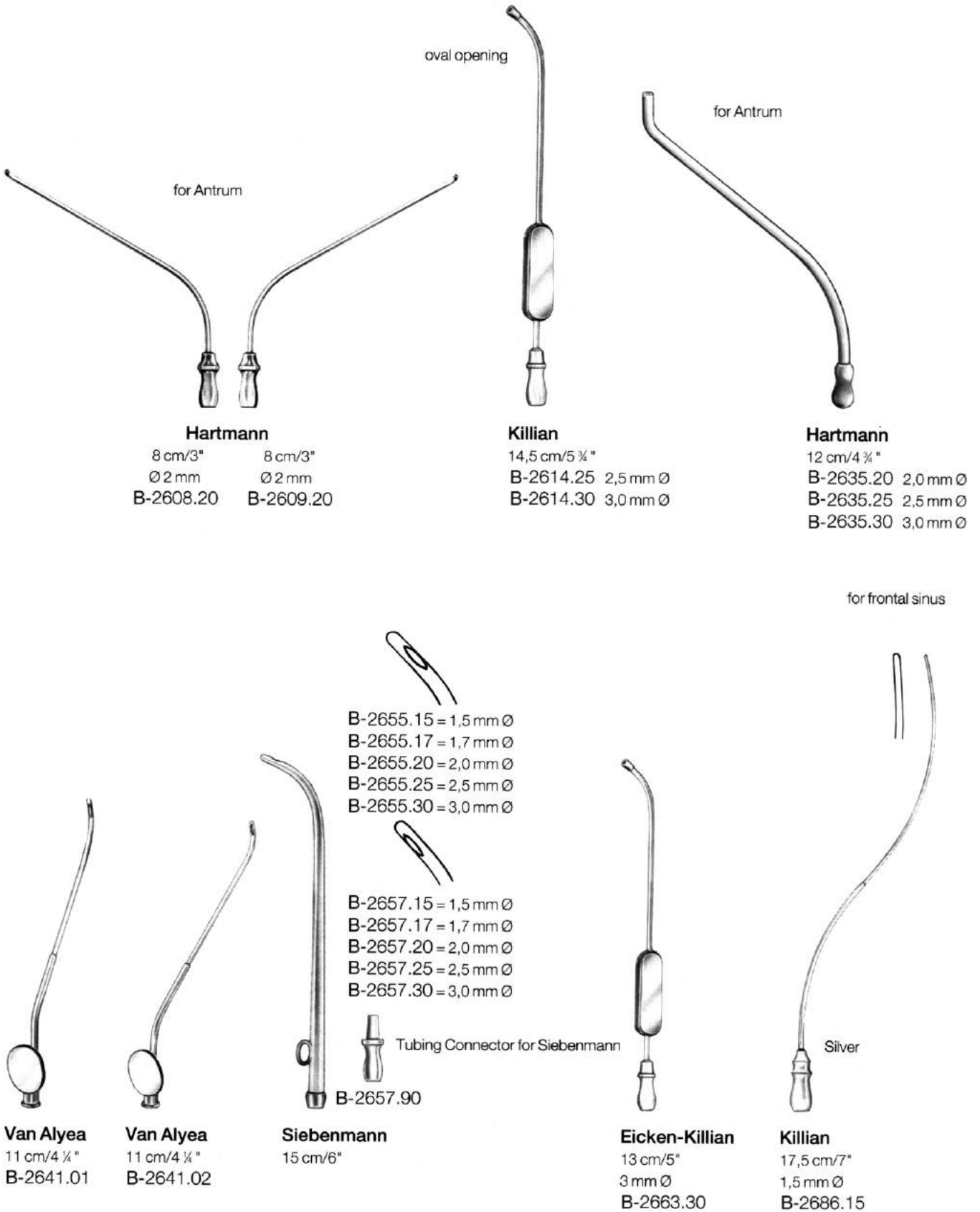

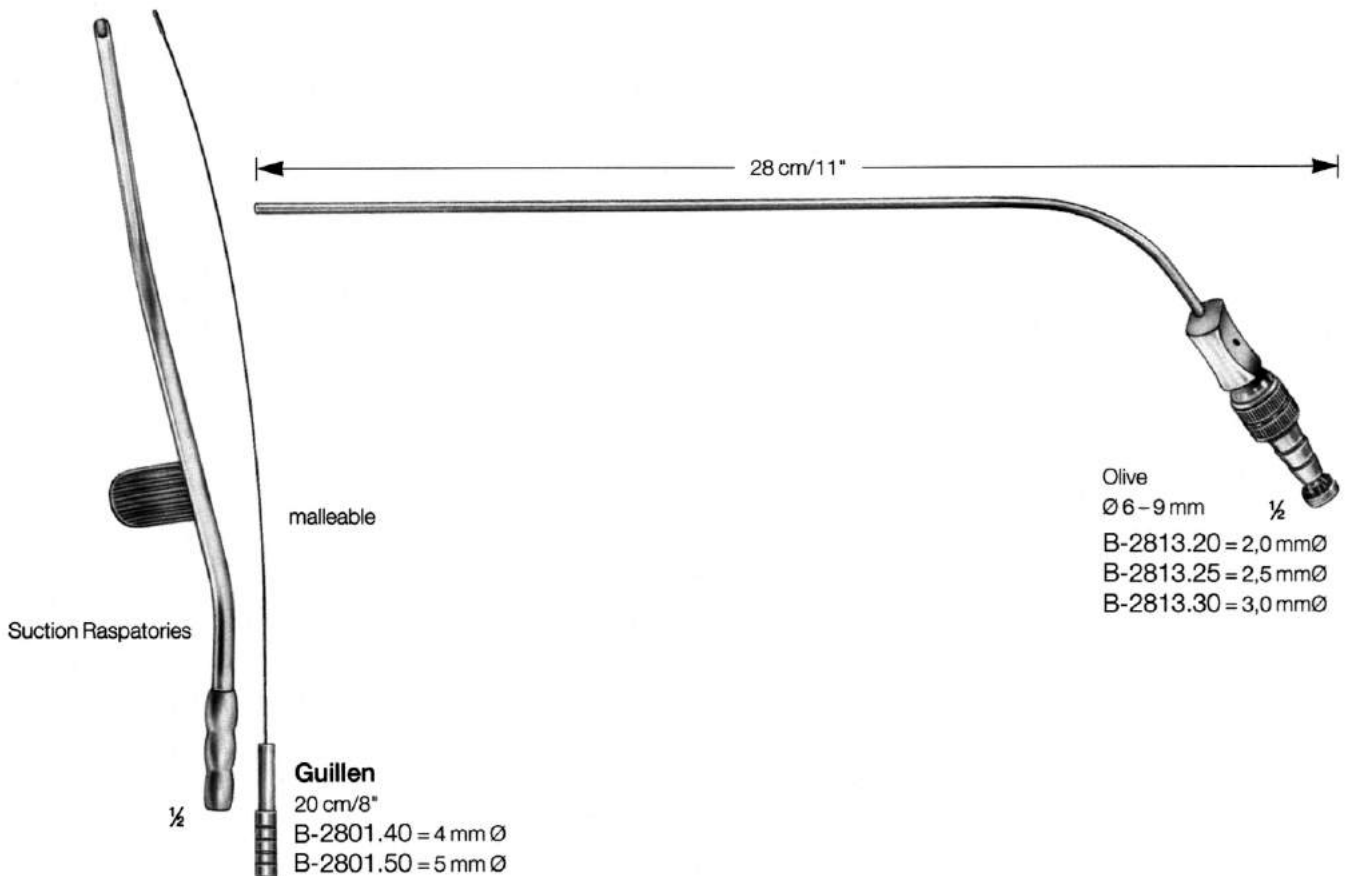
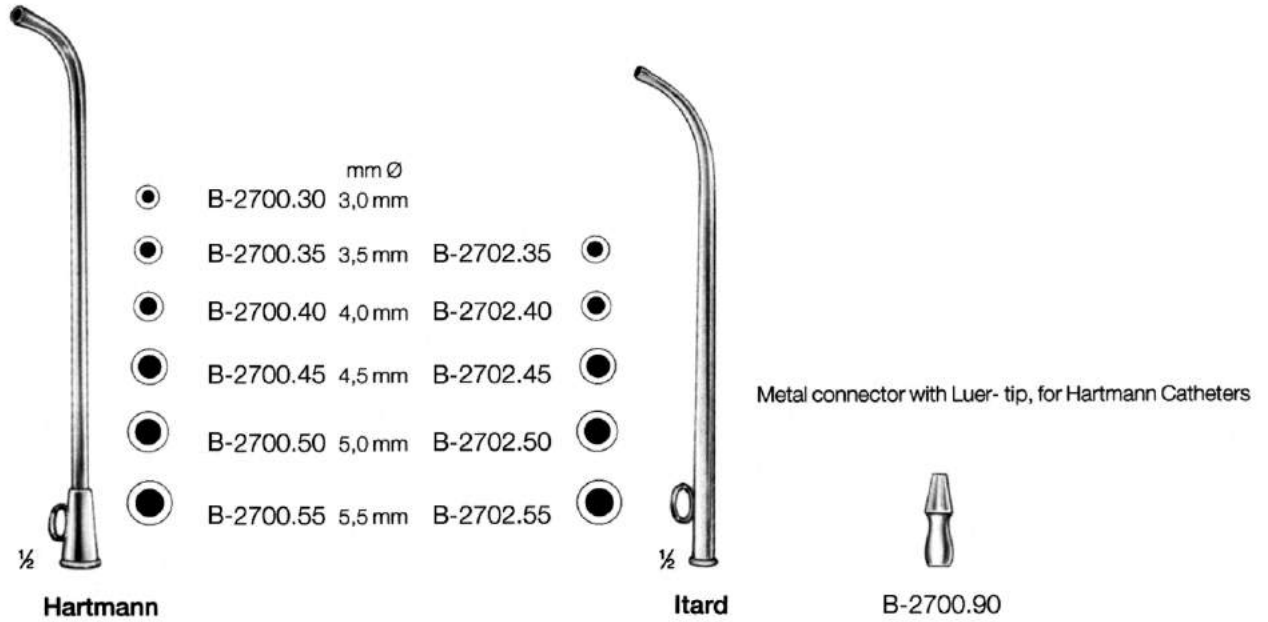



Metal female catheters

	mm Ø	Charr.
B-2951.06	2	6
B-2951.07	2 ½	7
B-2951.08	2 ¾	8
B-2951.09	3	9
B-2951.10	3 ½	10
B-2951.11	3 ¾	11
B-2951.12	4	12
B-2951.14	4 ¾	14
B-2951.16	5 ½	16
B-2951.18	6	18
B-2951.20	6 ¾	20
B-2951.22	7 ½	22
B-2951.24	8	24

16 cm/6 ¼"

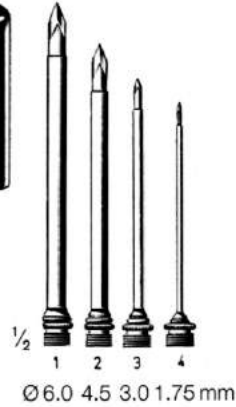

B-3003.00
 Universal trocar with 3 tips fig. 2, 3, 4

B-3004.00
 Universal trocar with 4 tips

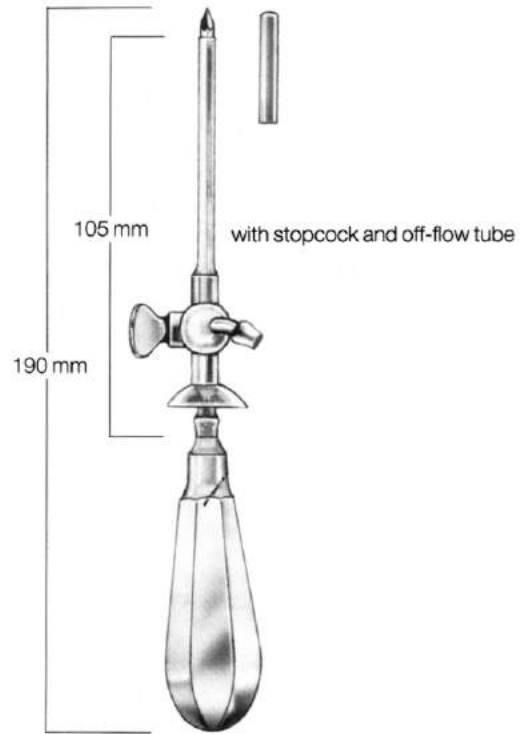
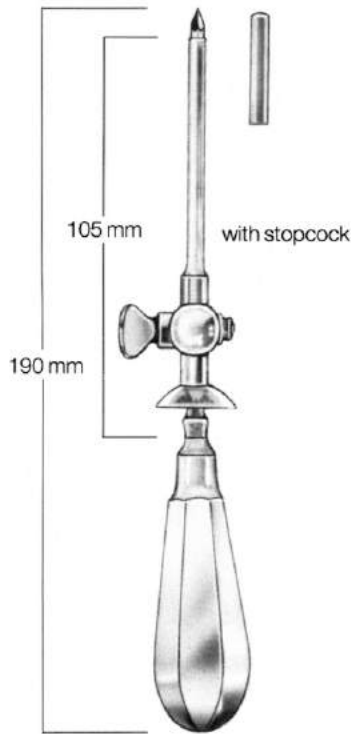
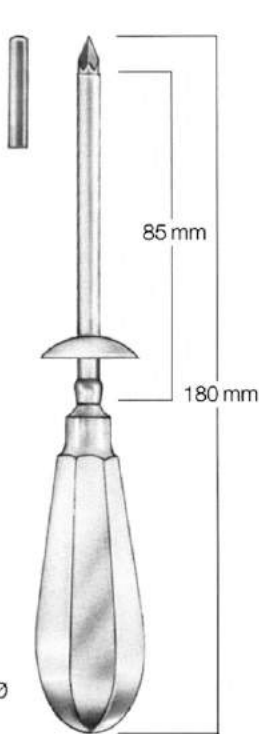

inside Ø outside Ø

mm	mm	Standard
2	3	B-3010.30
3	4	B-3010.40
4	5	B-3010.50
5	6	B-3010.60

Standard
B-3012.30
B-3012.40
B-3012.50
B-3012.60

Standard
B-3014.30
B-3014.40
B-3014.50
B-3014.60

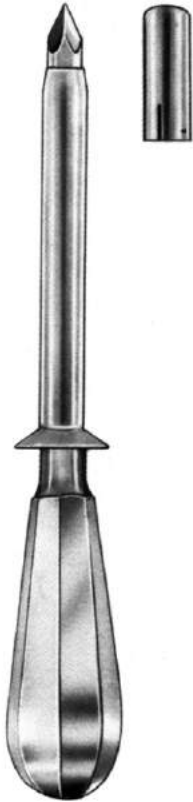

Nelson



Fig. 1
B-3020.75



Fig. 2
B-3020.90

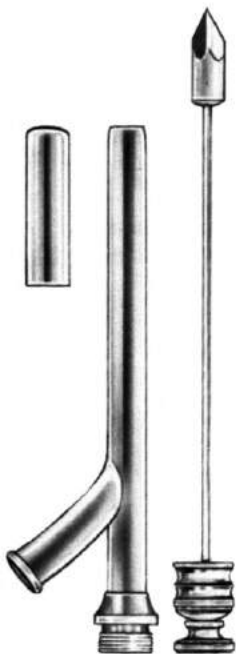

Fig. 3
B-3021.05



Fig. 4
B-3021.20

outside Ø mm	7,5	9,0	10,5	12,0
inside width mm	6,0	7,5	9,0	10,0
for catheter charr.	15	21	27	30



Ochsner

for gall bladder

Trocar for catheter

	Ø charr.	charr.
B-3034.10	10	6
B-3034.12	12	8
B-3034.14	14	10
B-3034.16	16	12
B-3034.18	18	14
B-3034.20	20	16
B-3034.22	22	18
B-3034.24	24	20
B-3034.26	26	22
B-3034.28	28	24

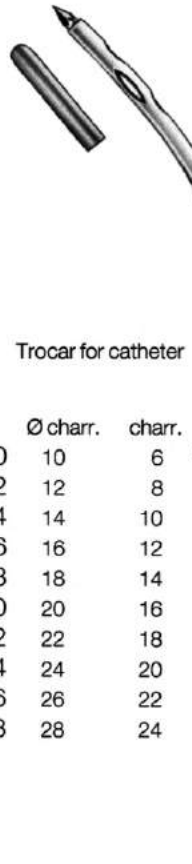

Inside Ø 4 mm
with 2 cannulas
4 and 5 mm outside Ø

Fleurant
23 cm/9"
5 mm Ø
B-3040.00

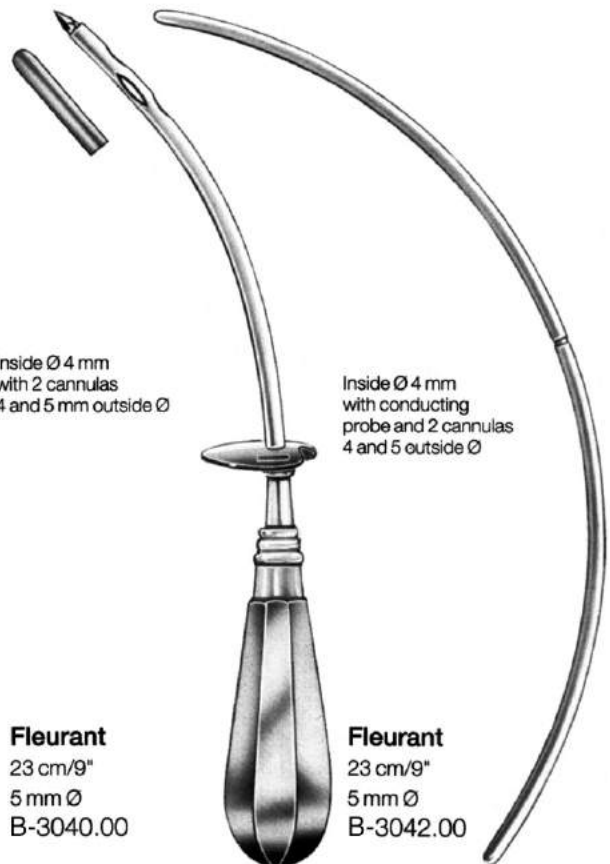

Inside Ø 4 mm
with conducting
probe and 2 cannulas
4 and 5 outside Ø

Fleurant
23 cm/9"
5 mm Ø
B-3042.00

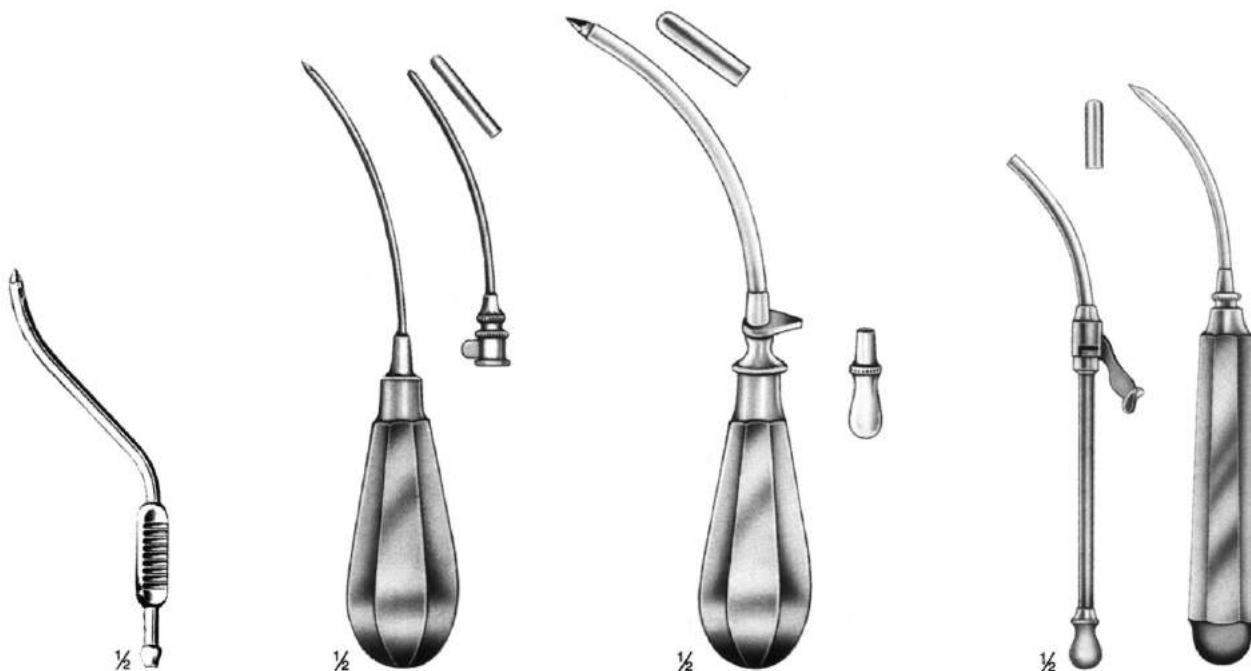

Douglas
Ø 3 mm
B-3115.30

Lichtwitz
15 cm/6"
Ø 2 mm
B-3122.20

Pierce
17 cm/6 ¾"
B-3131.30 Ø 3 mm
B-3131.40 Ø 4 mm
B-3131.50 Ø 5 mm

Coakley
14 cm/5 ½"
Ø 3 mm
B-3135.30

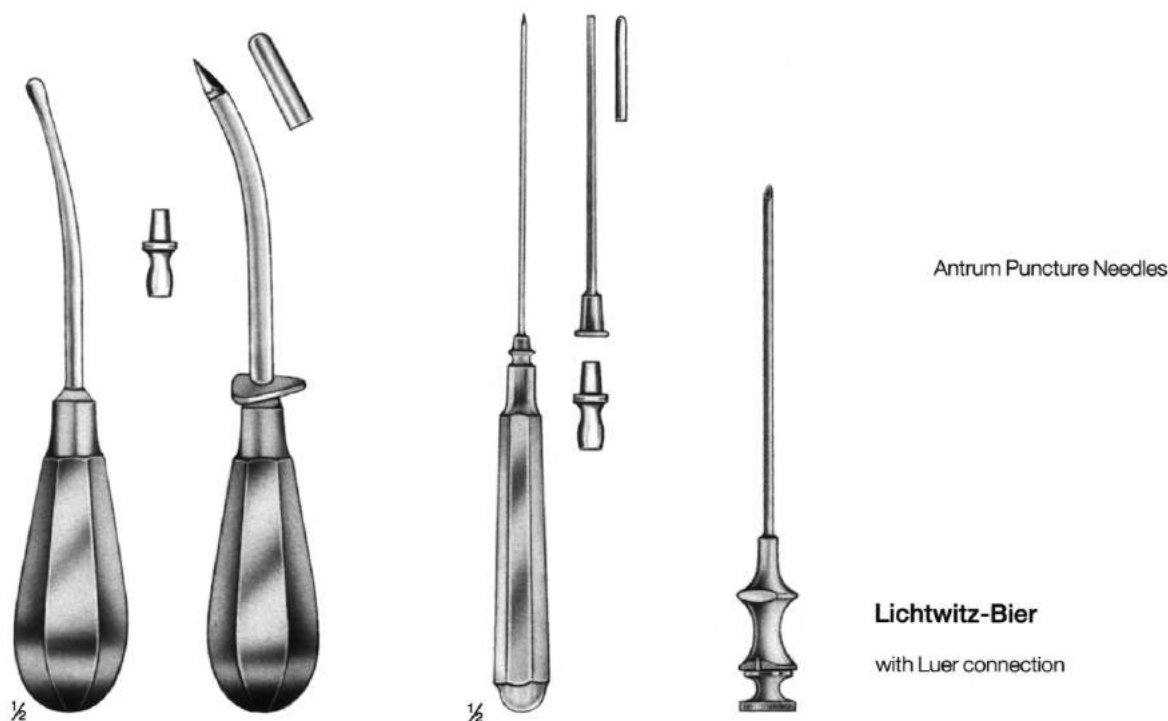

Krause
16 cm/6 ¼"
Ø 5,5 cm
B-3140.55

Lichtwitz
19 cm/7 ½"
Ø 1,8 mm
B-3154.18

Lichtwitz-Bier
with Luer connection

1,0 mm Ø x 80 mm	B-3170.10
1,2 mm Ø x 80 mm	B-3170.12
1,5 mm Ø x 80 mm	B-3170.15
1,8 mm Ø x 100 mm	B-3170.18

Antrum Puncture Needles

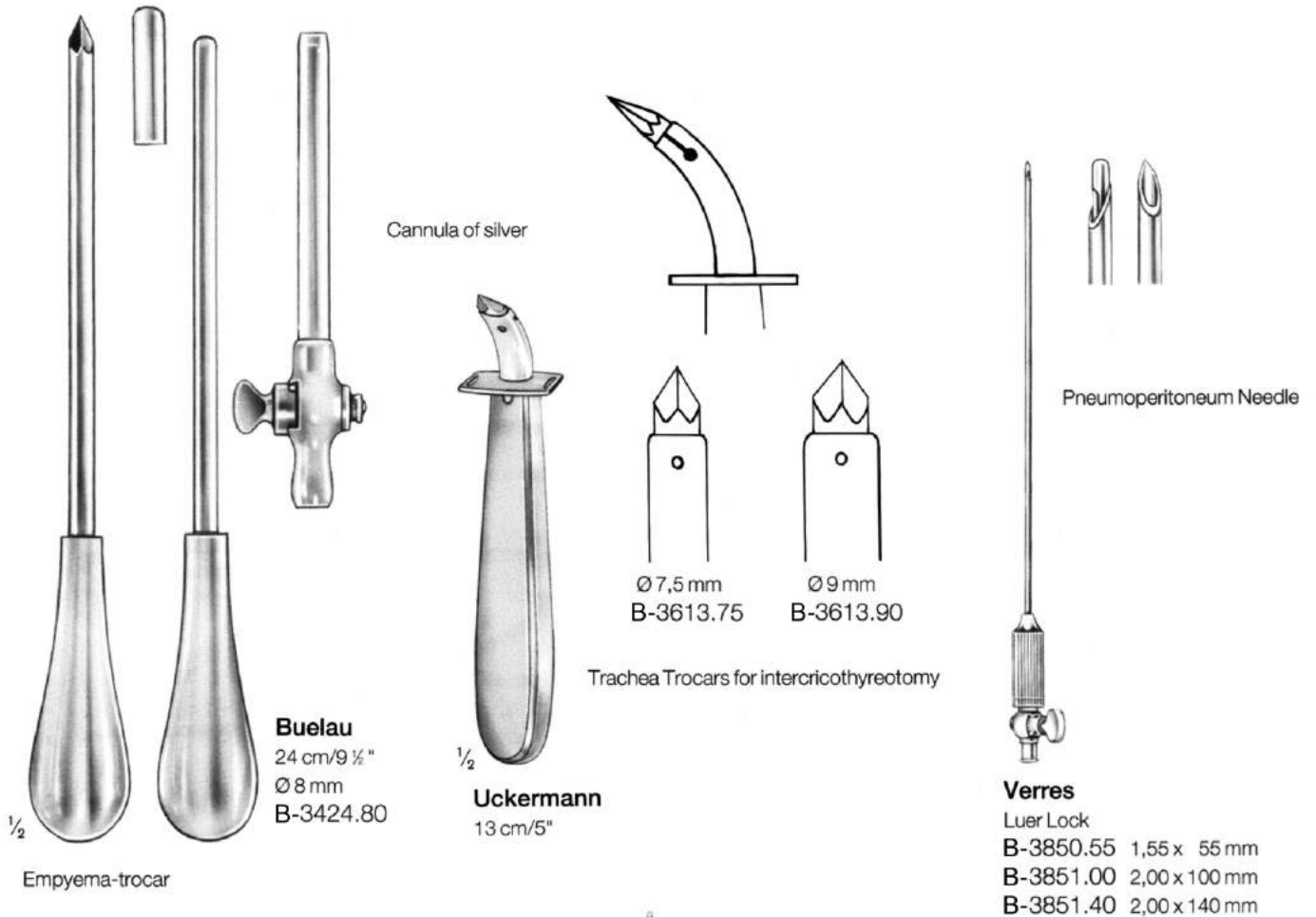

Liver Blind Puncture Needles, with Stopping Probe

Needles for controlled liver puncture

Trocars for introduction of liver puncture needles

- B-3810.35 = 1,00 x 35 mm
- B-3810.70 = 1,00 x 70 mm
- B-3812.70 = 1,20 x 70 mm
- B-3812.99 = 1,20 x 100 mm
- B-3814.70 = 1,40 x 70 mm
- B-3814.99 = 1,40 x 100 mm
- B-3816.70 = 1,60 x 70 mm
- B-3818.99 = 1,80 x 100 mm

Menghini

Menghini

- B-3830.14 = 1,40 x 168 mm
- B-3830.18 = 1,80 x 168 mm

- B-3830.64 = 1,40 mm Ø
- B-3830.68 = 1,80 mm Ø

Vein stripper set in metal case
Trousse pour stripping veineux en étui métal
Juego para várices, en estuche de metal

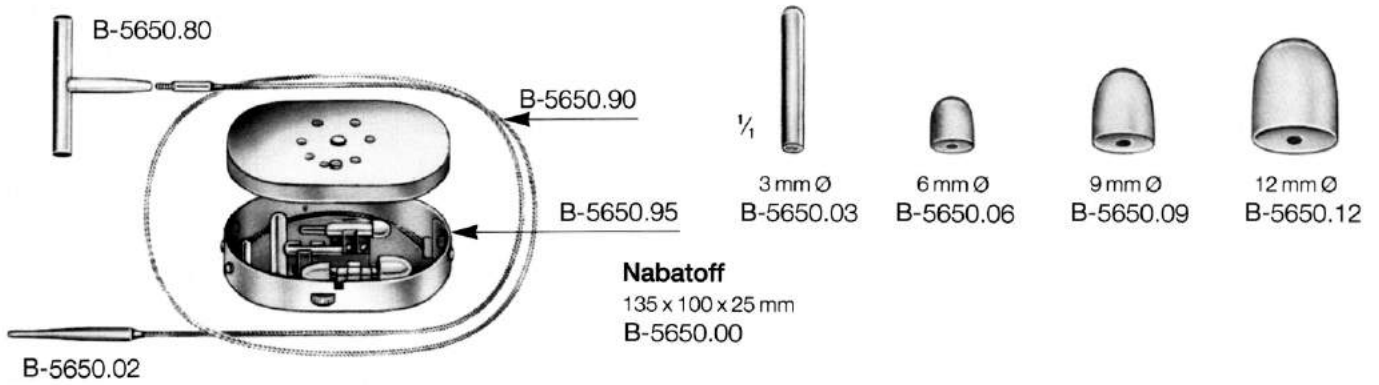

- Set complete, consisting of:
- B-5650.95 Case 135 x 100 x 25 mm
 - B-5650.80 Handle
 - B-5650.03 Metal-Probe Tip
 - B-5650.06 Olive 6 mm Ø
 - B-5650.09 Olive 9 mm Ø
 - B-5650.12 Olive 12 mm Ø
 - B-5650.90 Cable, length: 90 cm
 - B-5650.02 Plastic Probe Tip



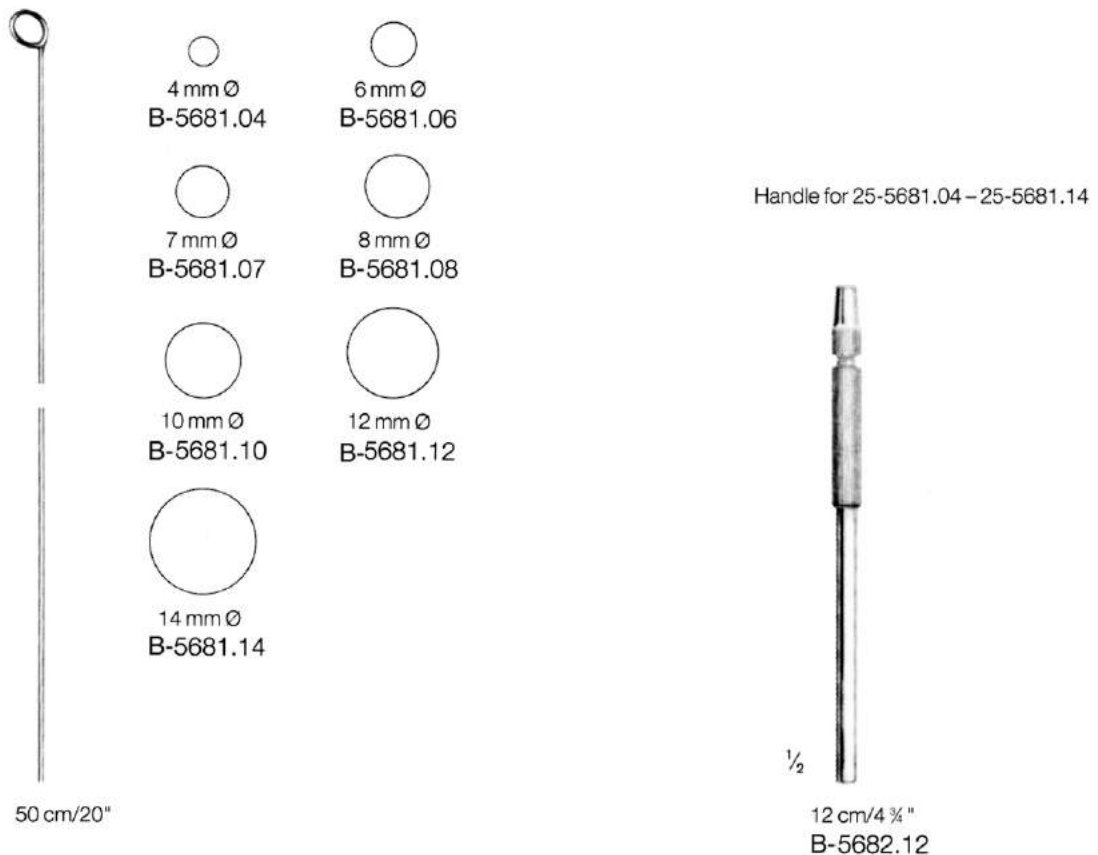

Endarterectomy Strippers







Vascular Dilators



malleable

$\frac{1}{4}$					
	1 mm	1,5 mm	2 mm	2,5 mm	3 mm
14 cm/5 $\frac{1}{2}$ "	B-5714.10	B-5714.15	B-5714.20	B-5714.25	B-5714.30
21 cm/8 $\frac{1}{4}$ "	B-5721.10	B-5721.15	B-5721.20	B-5721.25	B-5721.30

$\frac{1}{4}$				
	3,5 mm	4 mm	4,5 mm	5 mm
14 cm/5 $\frac{1}{2}$ "	B-5714.35	B-5714.40	B-5714.45	B-5714.50
21 cm/8 $\frac{1}{4}$ "	B-5721.35	B-5721.40	B-5721.45	B-5721.50













Garrett
14 cm/5 $\frac{1}{2}$ "
21 cm/8 $\frac{1}{4}$ "

Set complete
14 cm/5 $\frac{1}{2}$ "
B-5714.00

Set complete
21 cm/8 $\frac{1}{4}$ "
B-5721.00















malleable

$\frac{1}{4}$						
	0,5 mm	1,0 mm	1,5 mm	2,0 mm	2,5 mm	3,0 mm
	B-5819.05	B-5819.10	B-5819.15	B-5819.20	B-5819.25	25-5819.30
$\frac{1}{4}$						
	3,5 mm	4,0 mm	4,5 mm	5,0 mm	7,0 mm	9,0 mm
	B-5819.35	B-5819.40	B-5819.45	B-5819.50	B-5819.70	B-5819.90

DeBakey
19 cm/7 $\frac{1}{2}$ "



	$\frac{1}{4}$							
		1 mm Ø	2 mm Ø	3 mm Ø	4 mm Ø	5 mm Ø	6 mm Ø	7 mm Ø
21 cm/8 $\frac{1}{4}$ "				B-6021.03	B-6021.04	B-6021.05	B-6021.06	B-6021.07
30 cm/11 $\frac{3}{8}$ "	B-6030.01	B-6030.02	B-6030.03	B-6030.04	B-6030.05	B-6030.06	B-6030.07	
	$\frac{1}{4}$							
		8 mm Ø	9 mm Ø	10 mm Ø	11 mm Ø	12 mm Ø	13 mm Ø	
21 cm/8 $\frac{1}{4}$ "		B-6021.08	B-6021.09	B-6021.10	B-6021.11			
30 cm/11 $\frac{3}{8}$ "	B-6030.08	B-6030.09	B-6030.10	B-6030.11	B-6030.12	B-6030.13		

Bakes

malleable shaft

21 cm/8 $\frac{1}{4}$ "

B-6022.09

Set of 9, consisting of 1 each 3 thru 11 mm, in plastic pouch

B-6021.03 – 25-6021.11

3 mm Ø – 11 mm Ø

Filiform Bougie

33 cm/13"

Charr.
(French)

3 B-6133.30

4 B-6133.40

5 B-6133.50

6 B-6133.60



straight

Dittel
22,5 cm/9"



curved

Dittel
35,5 cm/14"

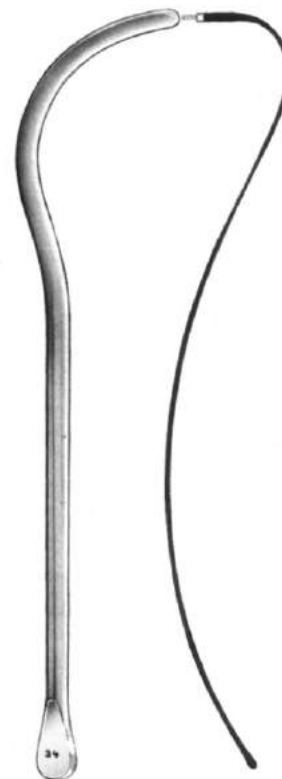

Guyon
25 cm/10"

mm Ø	Charr. (French)			
2½	8	B-6122.08		
3	9	B-6122.09		
3½	10	B-6122.10	B-6135.10	B-6155.10
3¾	11	B-6122.11	B-6135.11	B-6155.11
4	12	B-6122.12	B-6135.12	B-6155.12
4½	13	B-6122.13	B-6135.13	B-6155.13
4¾	14	B-6122.14	B-6135.14	B-6155.14
5	15	B-6122.15	B-6135.15	B-6155.15
5½	16	B-6122.16	B-6135.16	B-6155.16
5¾	17	B-6122.17	B-6135.17	B-6155.17
6	18	B-6122.18	B-6135.18	B-6155.18
6½	19	B-6122.19	B-6135.19	B-6155.19
6¾	20	B-6122.20	B-6135.20	B-6155.20
7	21	B-6122.21	B-6135.21	B-6155.21
7½	22	B-6122.22	B-6135.22	B-6155.22
7¾	23	B-6122.23	B-6135.23	B-6155.23
8	24	B-6122.24	B-6135.24	B-6155.24
8½	25	B-6122.25	B-6135.25	B-6155.25
8¾	26	B-6122.26	B-6135.26	B-6155.26
9	27	B-6122.27	B-6135.27	B-6155.27
9½	28	B-6122.28	B-6135.28	B-6155.28
9¾	29	B-6122.29	B-6135.29	B-6155.29
10	30	B-6122.30	B-6135.30	B-6155.30

Set of Dilating Sounds

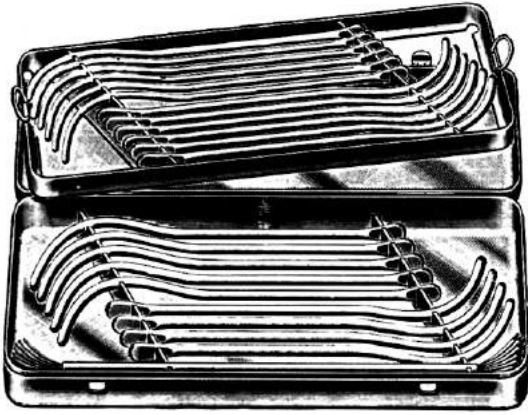

Set of Urethral Bougies and Dilating Sounds in metal case, containing:
21 Urethral Bougies, 10-11-12-13-14-15-16-17-18-
19-20-21-22-23-24-25-26-27-28-29-30
6 Filiform bougies in metal tube

¼

420 x 175 x 40 mm

Guyon
B-6174.21



½

Hank

B-6240.09	Fig. 9/10	4,5/ 5 mm Ø
B-6240.11	Fig. 11/12	5,5/ 6 mm Ø
B-6240.13	Fig. 13/14	6,5/ 7 mm Ø
B-6240.15	Fig. 15/16	7,5/ 8 mm Ø
B-6240.17	Fig. 17/18	8,5/ 9 mm Ø
B-6240.19	Fig. 19/20	9,5/10 mm Ø

Set of 6 dilators (9/10 - 19/20),
in canvas roll No. B-6241.96

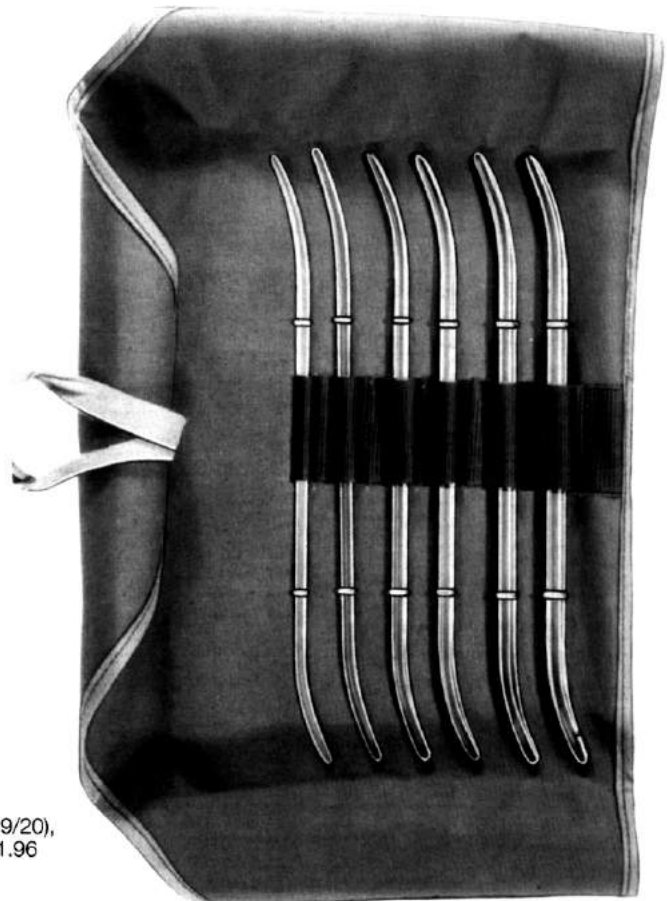

½

Hank
B-6241.06



Hegar

mm Ø			mm Ø		
1,0	B-6320.01		12,5		B-6331.25
1,5		B-6330.15	13,0	B-6320.13	
2,0	B-6320.02		13,5		B-6331.35
2,5		B-6330.25	14,0	B-6320.14	
3,0	B-6320.03		14,5		B-6331.45
3,5		B-6330.35	15,0	B-6320.15	
4,0	B-6320.04		15,5		B-6331.55
4,5		B-6330.45	16,0	B-6320.16	
5,0	B-6320.05		16,5		B-6331.65
5,5		B-6330.55	17,0	B-6320.17	
6,0	B-6320.06		17,5		B-6331.75
6,5		B-6330.65	18,0	B-6320.18	
7,0	B-6320.07		19,0	B-6320.19	
7,5		B-6330.75	20,0	B-6320.20	
8,0	B-6320.08		21,0	B-6320.21	
8,5		B-6330.85	22,0	B-6320.22	
9,0	B-6320.09		23,0	B-6320.23	
9,5		B-6330.95	24,0	B-6320.24	
10,0	B-6320.10		25,0	B-6320.25	
10,5		B-6331.05	26,0	B-6320.26	
11,0	B-6320.11				
11,5		B-6331.15			
12,0	B-6320.12				

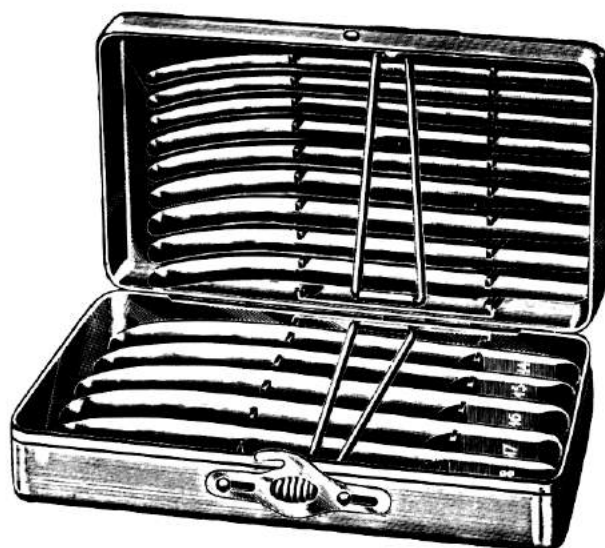

B-6325.14
 Set of 14 dilators 4 – 17 mm Ø in metal case

B-6325.26
 Set of 26 dilators 1 – 26 mm Ø in metal case



	mm Ø
B-6350.01	1 + 2
B-6350.03	3 + 4
B-6350.05	5 + 6
B-6350.07	7 + 8
B-6350.09	9 + 10
B-6350.11	11 + 12
B-6350.13	13 + 14
B-6350.15	15 + 16
B-6350.17	17 + 18
B-6350.19	19 + 20
B-6350.21	21 + 22
B-6350.23	23 + 24
B-6350.25	25 + 26

B-6351.08
 Set of 8 dilators
 3.0/4.0 – 17.0/18.0 mm Ø.

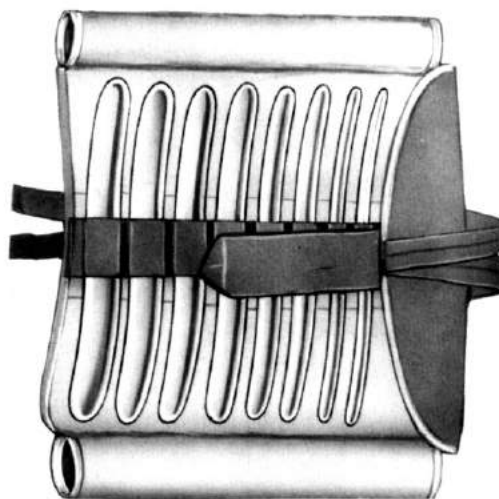

Hegar

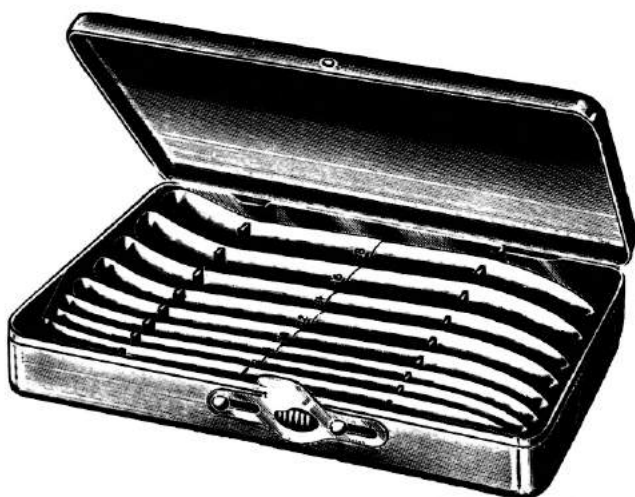

Hegar
B-6352.08
 Set of 8 dilators
 3.0/4.0 – 17.0/18.0 mm Ø,
 in metal case with hinged lid

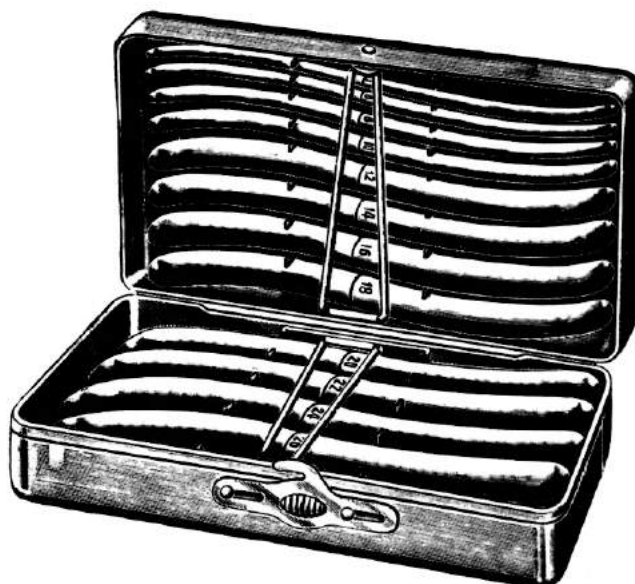

Hegar
B-6352.13
 Set of 13 dilators
 1.0/2.0 – 25.0/26.0 mm Ø,
 in metal case with hinged lid

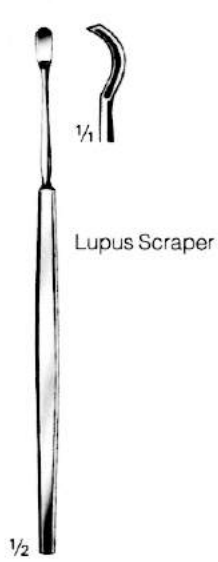

Vidal
14 cm/5 1/2"
B-7104.14



Unna
14 cm/5 1/2"
B-7114.14



Unna
14 cm/5 1/2"
B-7115.14



Saalfeld
10 cm/4"
B-7120.10

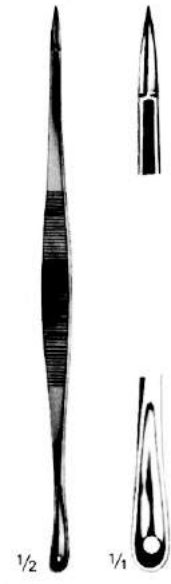

Saalfeld
14 cm/5 1/2"
B-7122.14

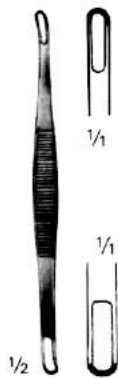

Schamberg
10 cm/4"
B-7124.10

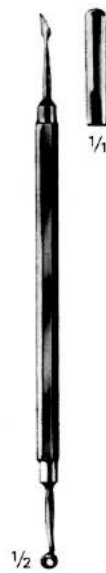

Katsch
14 cm/5 1/2"
B-7126.14

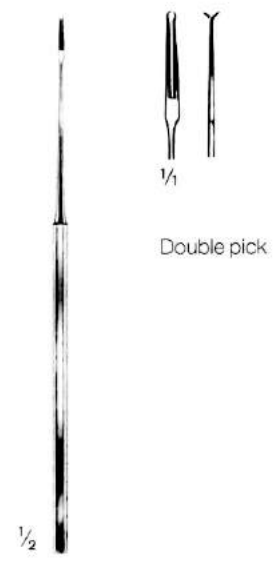

14 cm / 5 1/2"
B-0460.14

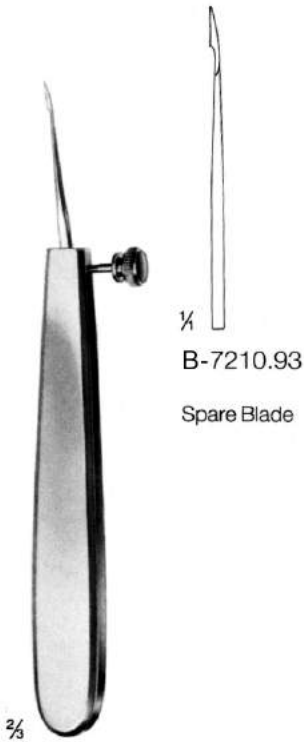

Moncorps
13 cm / 5"
B-7210.13



12 cm / 4 ¾"

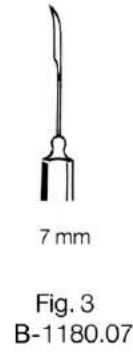
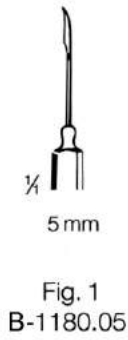

Tönnis
13,5 cm / 5"
B-5010.13

Cutaneous Punches

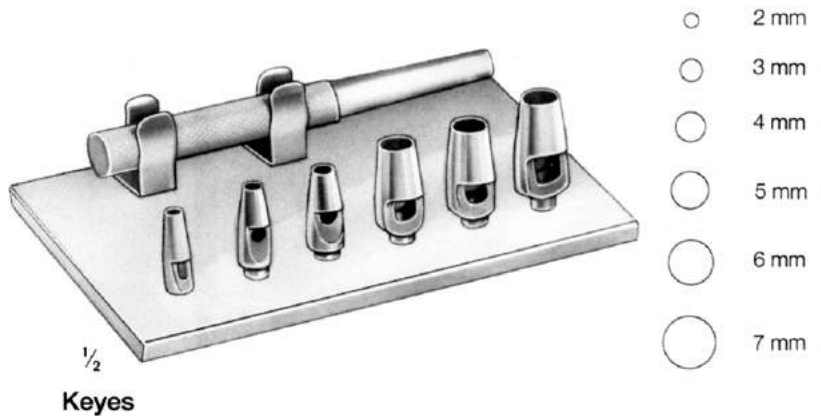
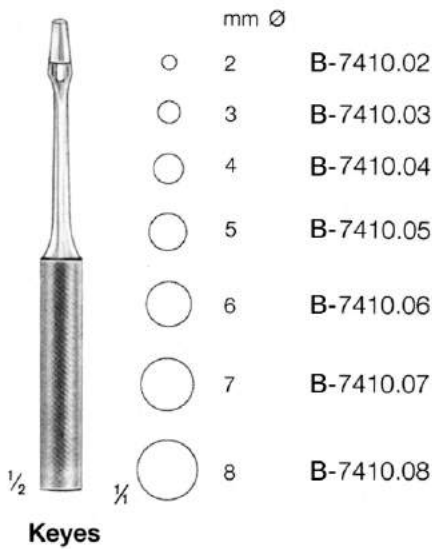

Set complete

B-7460.00

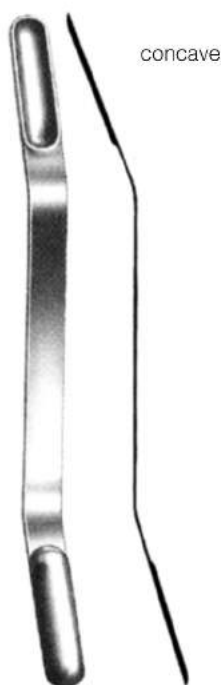

concave

Olivecrona
18 cm/7"

Width of spatulas

7 mm + 9 mm	B-2253.07
11 mm + 13 mm	B-2253.11
15 mm + 18 mm	B-2253.15
18 mm + 22 mm	B-2253.18

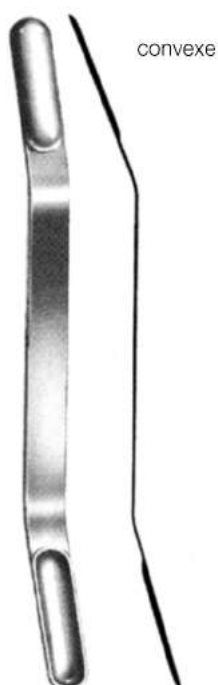

convexe

Olivecrona
18 cm/7"

Width of spatulas

7 mm + 9 mm	B-2255.07
11 mm + 13 mm	B-2255.11
15 mm + 18 mm	B-2255.15
18 mm + 22 mm	B-2255.18



Olivecrona
18 cm/7"

Width of spatulas

7 mm + 9 mm	B-2258.07
11 mm + 13 mm	B-2258.11
15 mm + 18 mm	B-2258.15
18 mm + 22 mm	B-2258.18

Brain Spatulas, malleable

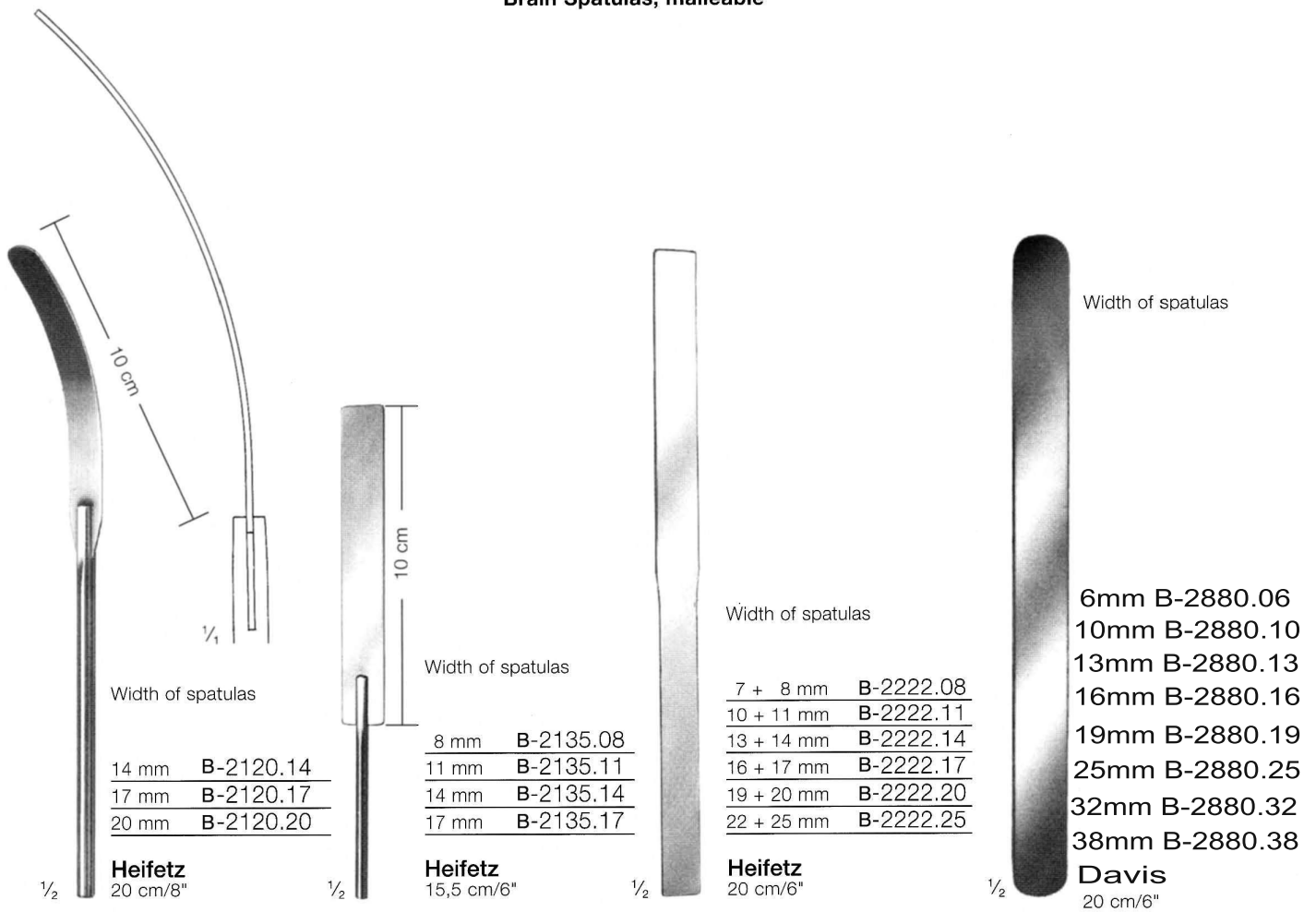

Heifetz
20 cm/8"

Width of spatulas

14 mm	B-2120.14
17 mm	B-2120.17
20 mm	B-2120.20

Heifetz
15,5 cm/6"

Width of spatulas

8 mm	B-2135.08
11 mm	B-2135.11
14 mm	B-2135.14
17 mm	B-2135.17

Heifetz
20 cm/6"

Width of spatulas

7 + 8 mm	B-2222.08
10 + 11 mm	B-2222.11
13 + 14 mm	B-2222.14
16 + 17 mm	B-2222.17
19 + 20 mm	B-2222.20
22 + 25 mm	B-2222.25

Davis
20 cm/6"

Width of spatulas

6mm	B-2880.06
10mm	B-2880.10
13mm	B-2880.13
16mm	B-2880.16
19mm	B-2880.19
25mm	B-2880.25
32mm	B-2880.32
38mm	B-2880.38

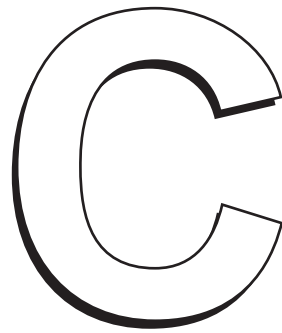

- Forceps
- Pincers
- Pinzas

Dressing forceps Pincès à disséquer Pinzas de disección



3,4 mm



Standard

1,3 mm



very fine

1,7 mm



delicate

2,3 mm



medium

2,5 mm



slender

cm	inch.						
11,5	4 ½	C-0200.11		C-0204.11		C-0208.11	
13	5	C-0200.13		C-0204.13		C-0208.13	
14,5	5 ¾	C-0200.14	C-0202.14	C-0204.14	C-0206.14	C-0208.14	
16	6 ¼	C-0200.16				C-0208.16	
18	7	C-0200.18				C-0208.18	
20	8	C-0200.20				C-0208.20	
25	10	C-0200.25				C-0208.25	
30	12	C-0200.30					



Standard

Modell USA

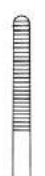

slender

Modell USA



¼

Swedish pattern

C-0320.13



½

Duehrssen
20 cm/8"
C-0346.20

cm	inch.			
13	5	C-0310.13	C-0312.13	C-0320.13
14,5	5 ¾	C-0310.14	C-0312.14	
15	6	C-0310.15	C-0312.15	C-0320.15
17	6 ¾			C-0320.17
20	8	C-0310.20		C-0320.20

Fine dressing forceps

Pinces à disséquer à mors fins

Pinzas de disección finas

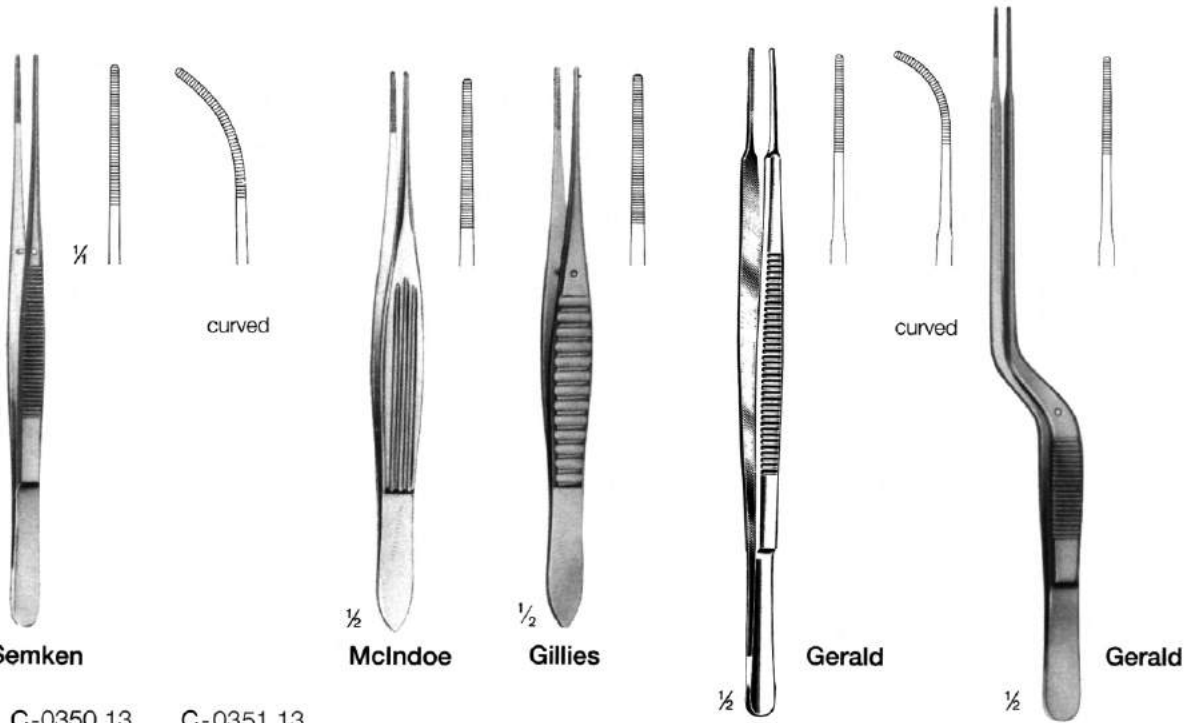

cm	inch.						
13	5	C-0350.13	C-0351.13				
14,5	5 1/4	C-0350.14	C-0351.14				
15	6			C-0360.15	C-0366.15		
16	6 1/4	C-0350.16	C-0351.16				
18	7	C-0350.18	C-0351.18			C-0370.18	C-0371.18 C-0372.18

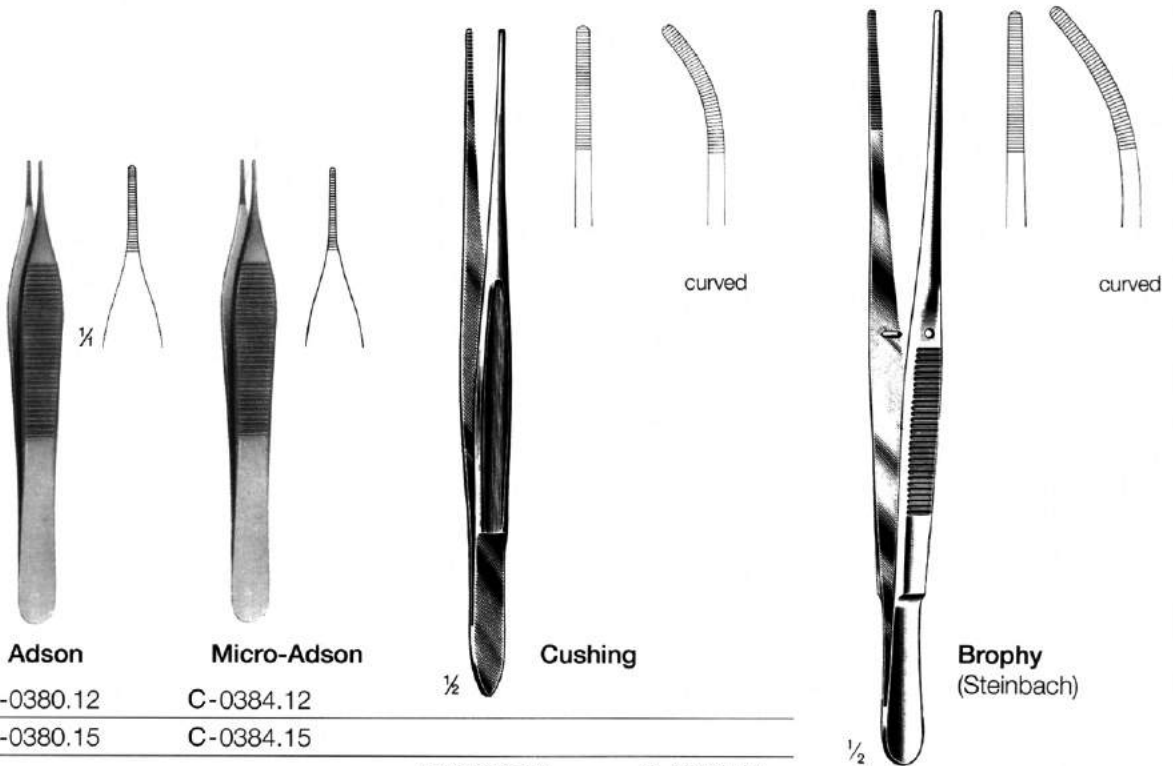

cm	inch.						
12	4 1/4	C-0380.12	C-0384.12				
15	6	C-0380.15	C-0384.15				
17,5	7			C-0390.17	C-0391.17		
20	8					C-0400.20	C-0401.20

Fine dressing forceps
Pinces à disséquer à mors fins
Pinzas de disección finas

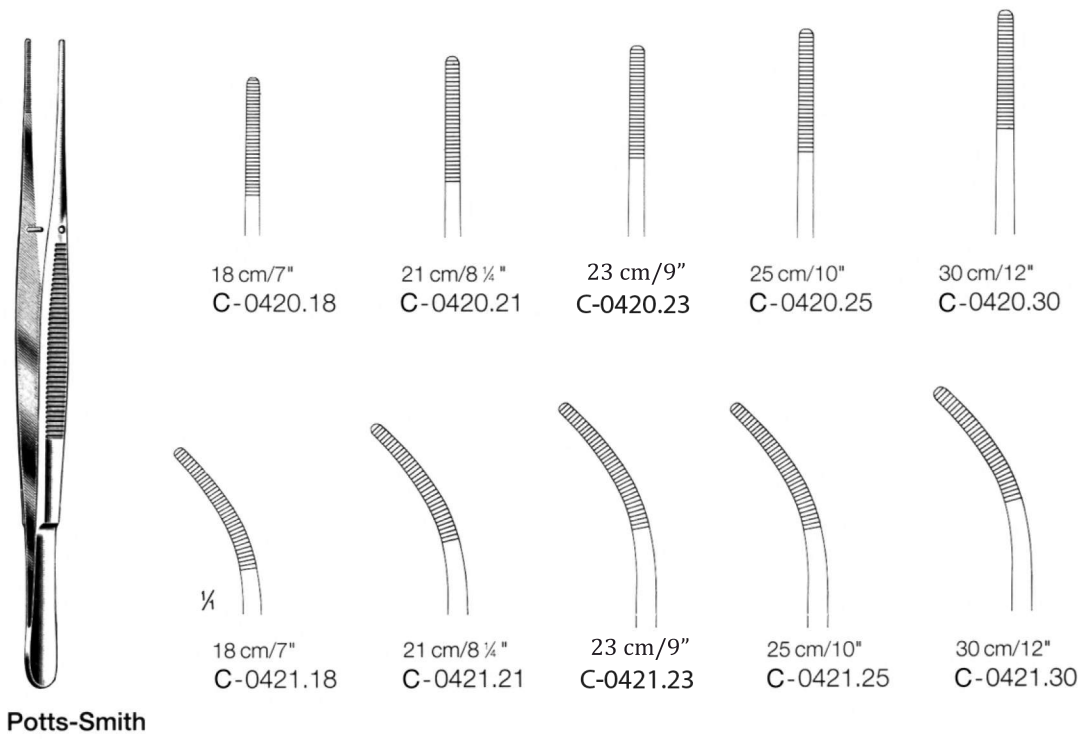

Microscopic Forceps with guide pin

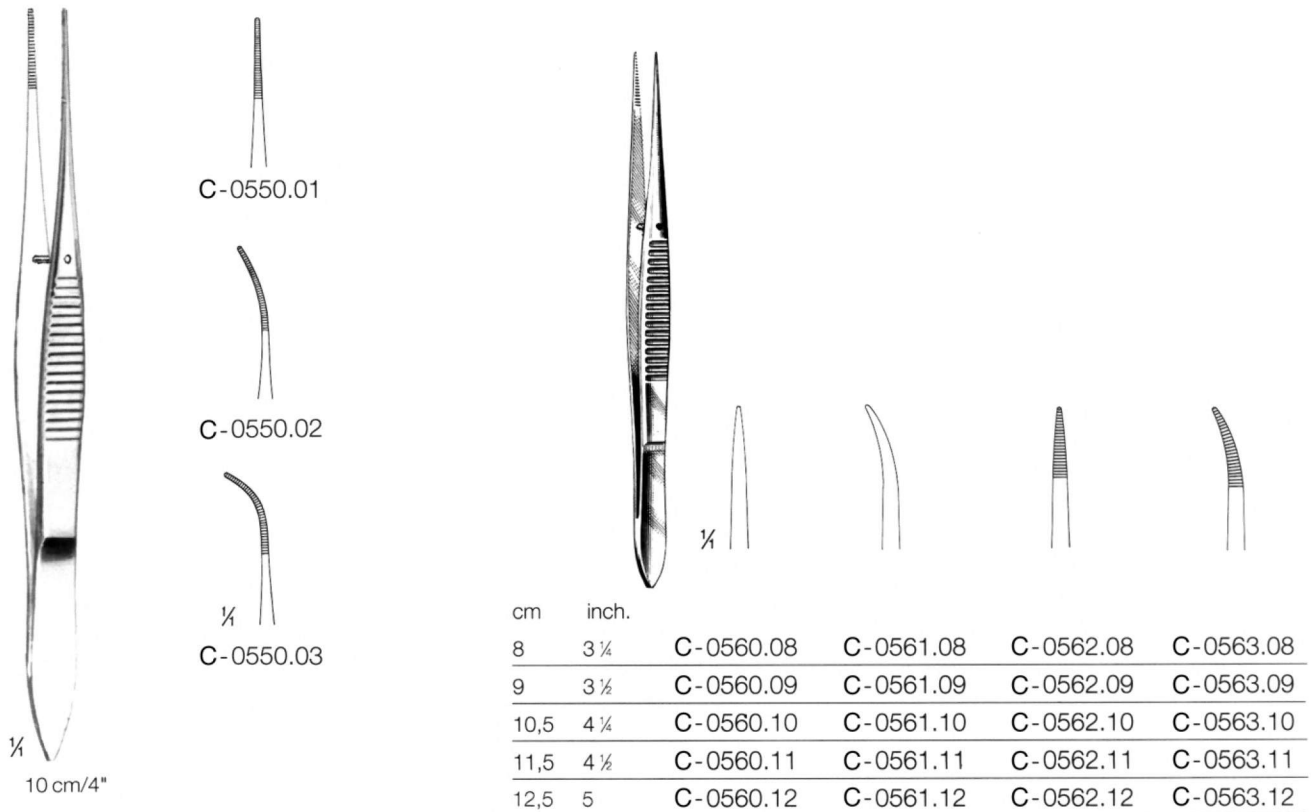

Tissue forceps
Pinces à griffes
Pinzas quirúrgicas

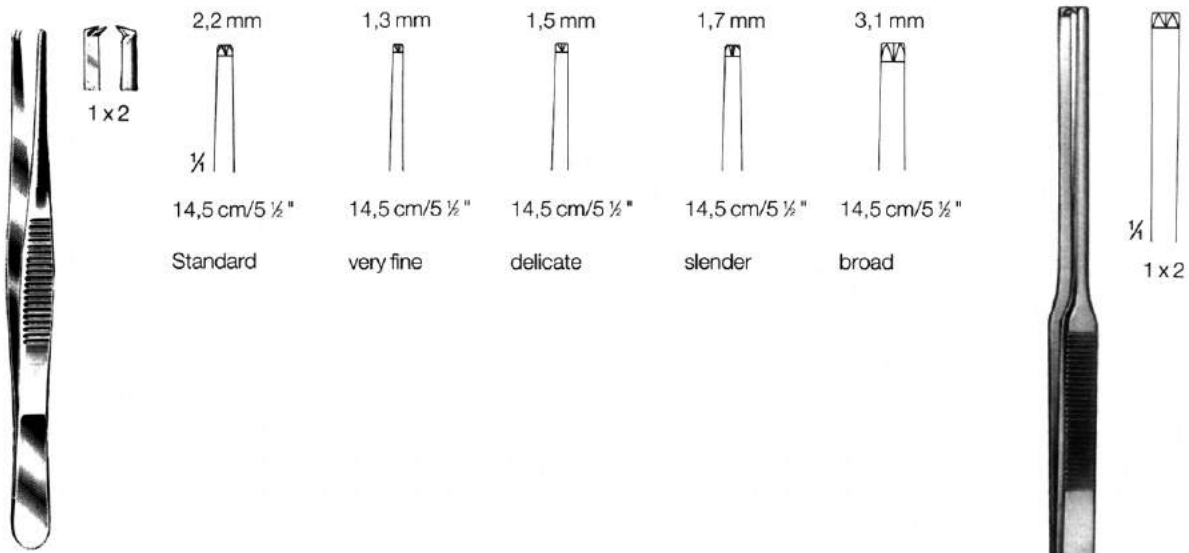

cm	inch.						
11,5	4 ½	C-1200.11		C-1204.11	C-1208.11		
13	5	C-1200.13		C-1204.13	C-1208.13		
14,5	5 ¾	C-1200.14	C-1202.14	C-1204.14	C-1208.14	C-1216.14	
16	6 ¼	C-1200.16			C-1208.16		
18	7	C-1200.18			C-1208.18		
20	8	C-1200.20			C-1208.20	C-1346.20	
25	10	C-1200.25			C-1208.25		
30	12	C-1200.30					

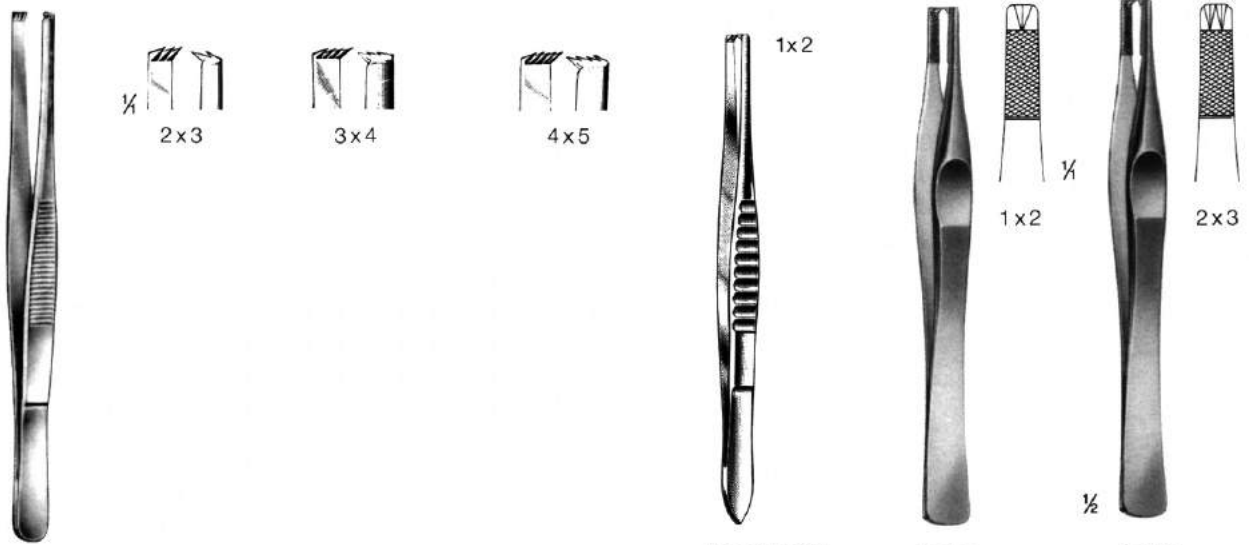

cm	inch.						
13	5	C-1223.13	C-1234.13	C-1245.13	C-1310.13		
14,5	5 ¾	C-1223.14	C-1234.14	C-1245.14	C-1310.14	C-1332.14	C-1334.14
16	6 ¼	C-1223.16	C-1234.16	C-1245.16			
18	7	C-1223.18					
20	8	C-1223.20				C-1332.20	

Fine tissue forceps
Pinces à griffes fins
Pinzas de disección con dientes finas

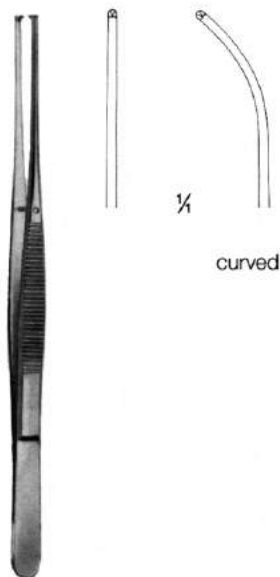

Semken



McIndoe



Gillies

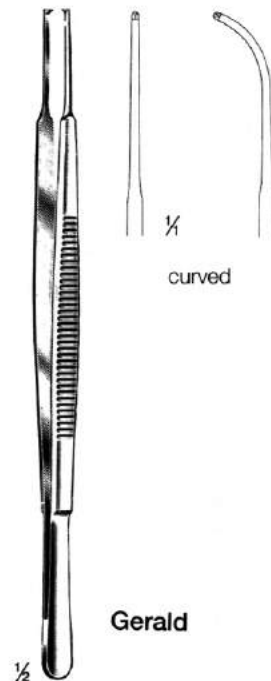

Gerald

cm	inch.				
13	5	C-1350.13	C-1351.13		
14,5	5 7/8	C-1350.14	C-1351.14		
15	6			C-1360.15	C-1366.15
16	6 1/4	C-1350.16	C-1351.16		
18	7	C-1350.18	C-1351.18		C-1370.18 04-1371.18



Gerald



Adson



Adson



Micro-Adson

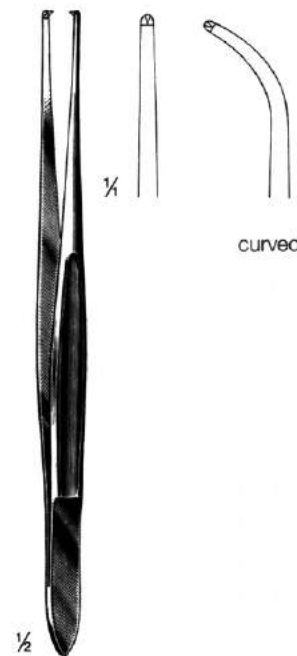

Cushing

cm	inch.				
12	4 3/4		C-1380.12	C-1382.12	C-1384.12
15	6		C-1380.15		C-1384.15
17,5	7				C-1390.17 C-1391.17
18	7	C-1372.18			

Fine tissue forceps
Pinces à griffes fins
Pinzas de disección con dientes finas

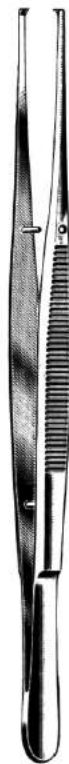

Potts-Smith

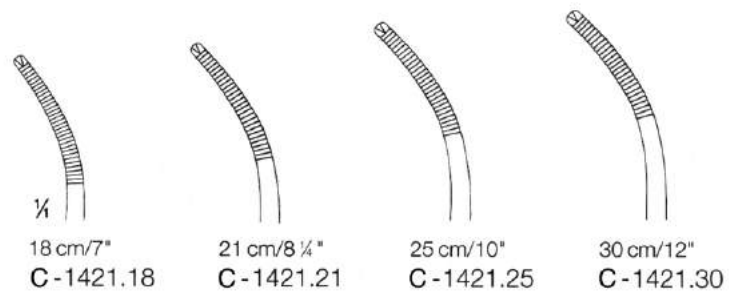
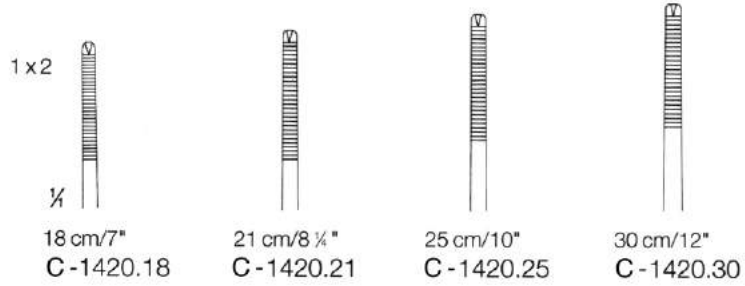

Microscopic Forceps



Brophy
 20 cm/8"

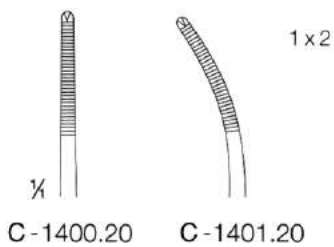

10 cm/4"

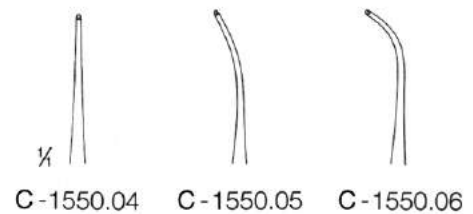



DeBakey-Diethrich



1,5 mm

cm	inch.	
15	6	C-2015.15
20	8	C-2015.20
24	9½	C-2015.24



DeBakey



1,5 mm



2,0 mm



2,8 mm

cm	inch.			
15	6	C-2115.15	C-2120.15	C-2128.15
20	8	C-2115.20	C-2120.20	C-2128.20
24	9½	C-2115.24	C-2120.24	C-2128.24
30	12		C-2120.30	C-2128.30



1/4



2,7 mm

cm	inch.		
15	6	C-2121.15	
20	8	C-2121.20	
24	9½	C-2121.24	
30	12	C-2121.30	C-2127.30



1/4
2,7 mm

DeBakey



3,5 mm

DeBakey



2,0 mm

Cooley



1,2 mm



18 cm/7" C-2948.12
21 cm/8 1/4" C-2951.12

2,0 mm



1/4
18 cm/7" C-2948.20
21 cm/8 1/4" C-2951.20

DeBakey
Ø8 mm

cm	inch.			
15	6	C-2427.15	C-2435.15	C-2920.15
20	8	C-2427.20	C-2435.20	C-2920.20
24	9 1/2	C-2427.24	C-2435.24	C-2920.24
30	12	C-2427.30	C-2435.30	

without spring catch

with spring catch

without spring catch

with spring catch



Green
10 cm/4"



Green
10 cm/4"



Graefe
11 cm/4 1/2"
C-5020.11



Graefe
11 cm/4 1/2"
C-5022.11

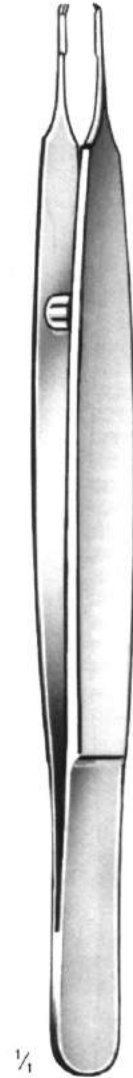

St. Martin-Gomel
14 cm/5 1/2"
C-5030.14

width

5,0mm	C-5010.05	C-5012.05
10,0mm	C-5010.10	C-5012.10
12,5mm	C-5010.12	C-5012.12

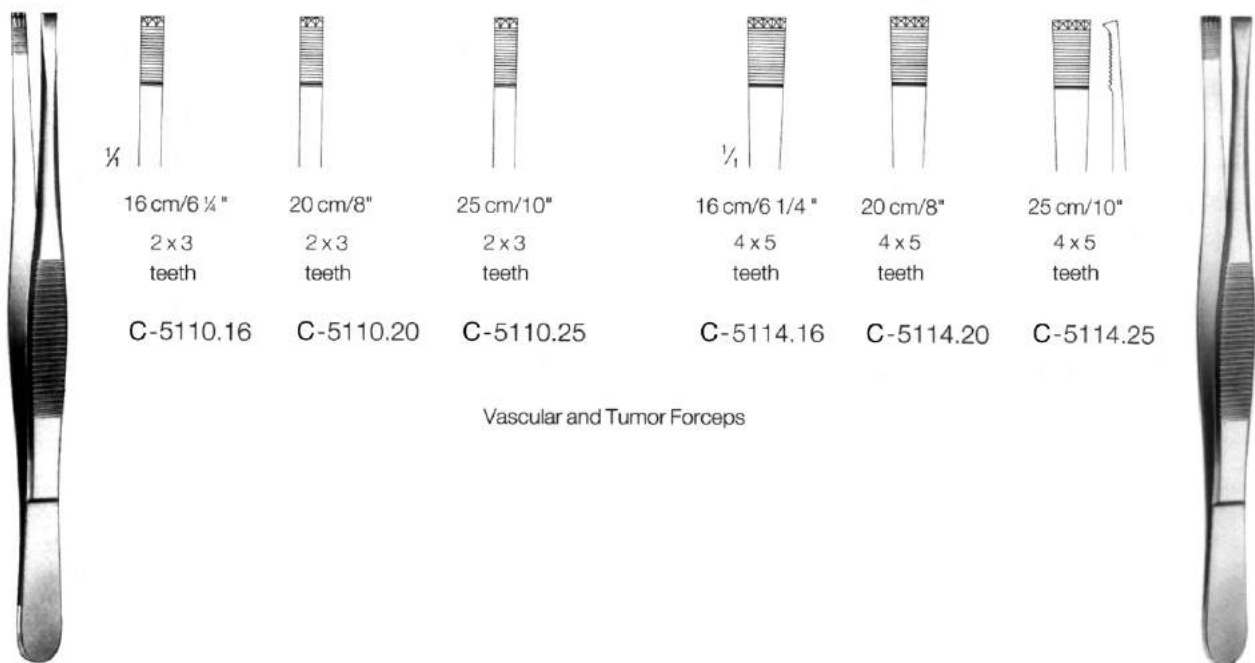

1/4				1/4		
16 cm/6 1/4"	20 cm/8"	25 cm/10"	16 cm/6 1/4"	20 cm/8"	25 cm/10"	
2 x 3 teeth	2 x 3 teeth	2 x 3 teeth	4 x 5 teeth	4 x 5 teeth	4 x 5 teeth	
C-5110.16	C-5110.20	C-5110.25	C-5114.16	C-5114.20	C-5114.25	

Vascular and Tumor Forceps

Adlerkreutz

Adlerkreutz

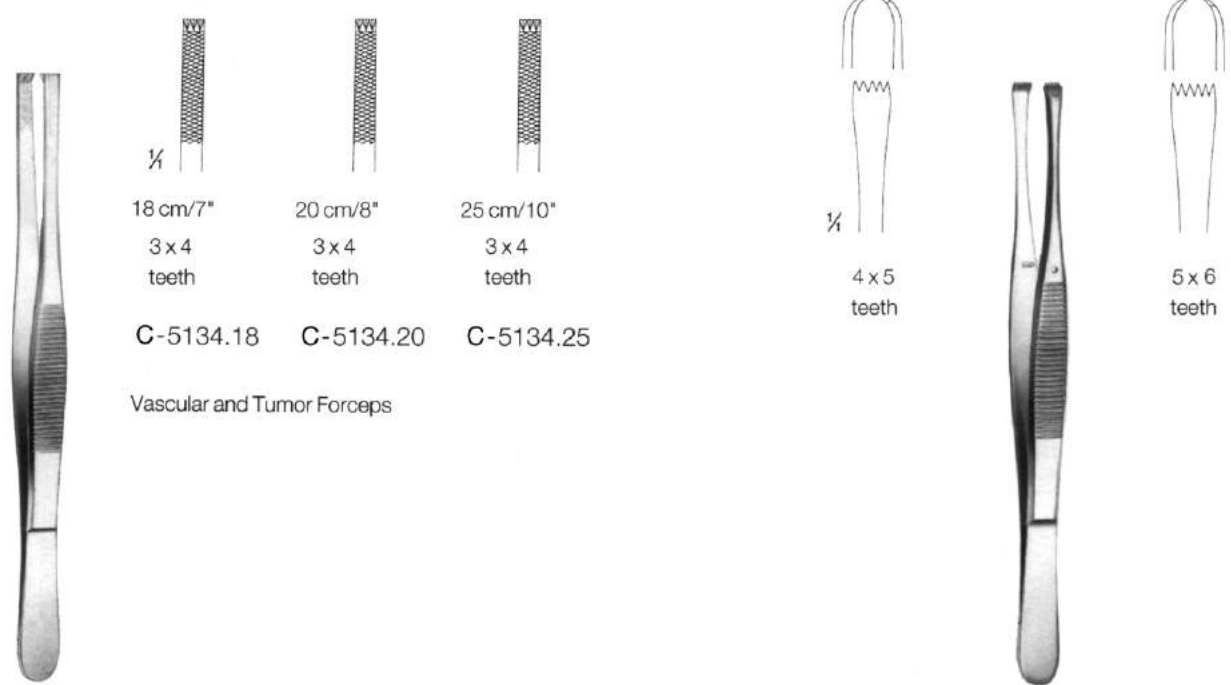

1/4		
18 cm/7"	20 cm/8"	25 cm/10"
3 x 4 teeth	3 x 4 teeth	3 x 4 teeth
C-5134.18	C-5134.20	C-5134.25

Vascular and Tumor Forceps

1/4	
4 x 5 teeth	5 x 6 teeth

Stille-Barraya

Stone
 15 cm/6"
 C-5140.15

Lerche
 15 cm/6"
 C-5146.15

Vascular and Tumor Forceps

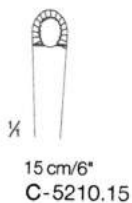

Russ. Modell



DENIS BROWNE
 20.0 cm, 8"
 C-5260.20



Mayo-Russ.
 23 cm/9"
 C-5214.23

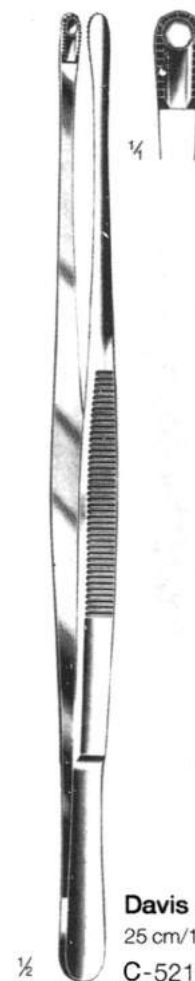

Davis
 25 cm/10"
 C-5218.25

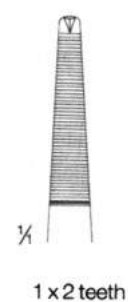

Bonney
 18 cm/7"

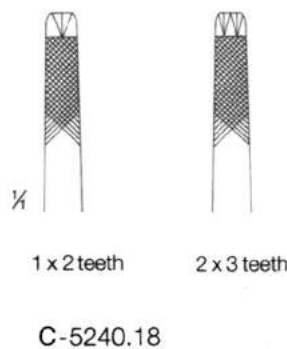

Ferris-Smith
 18 cm/7"

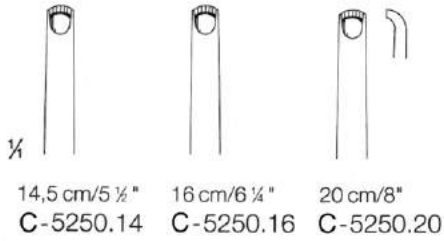

14,5 cm/5 1/2" C-5250.14
 16 cm/6 1/4" C-5250.16
 20 cm/8" C-5250.20

Durante

Lung Grasping Forceps

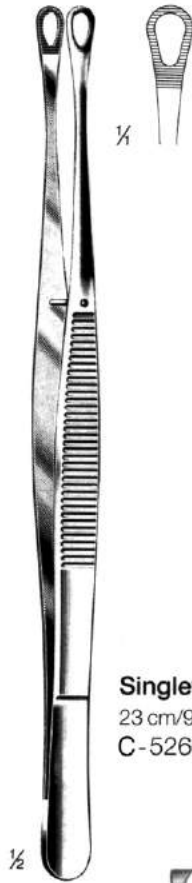

Singley (Tuttle)
 23 cm/9"
 C-5260.23



6 x 7 teeth

Nelson
 23 cm/9"
 C-5270.23

Intestinal Forceps

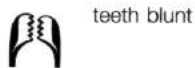

teeth blunt

11 cm/4 1/2" C-5274.11
 15 cm/6" C-5274.15

Allis



teeth blunt

cm	inch.	
20	8	C-5274.20
23	9	C-5274.23
30	12	C-5274.30

Allis

Grasping forceps
Pinces pour préhension
Pinzas para coger

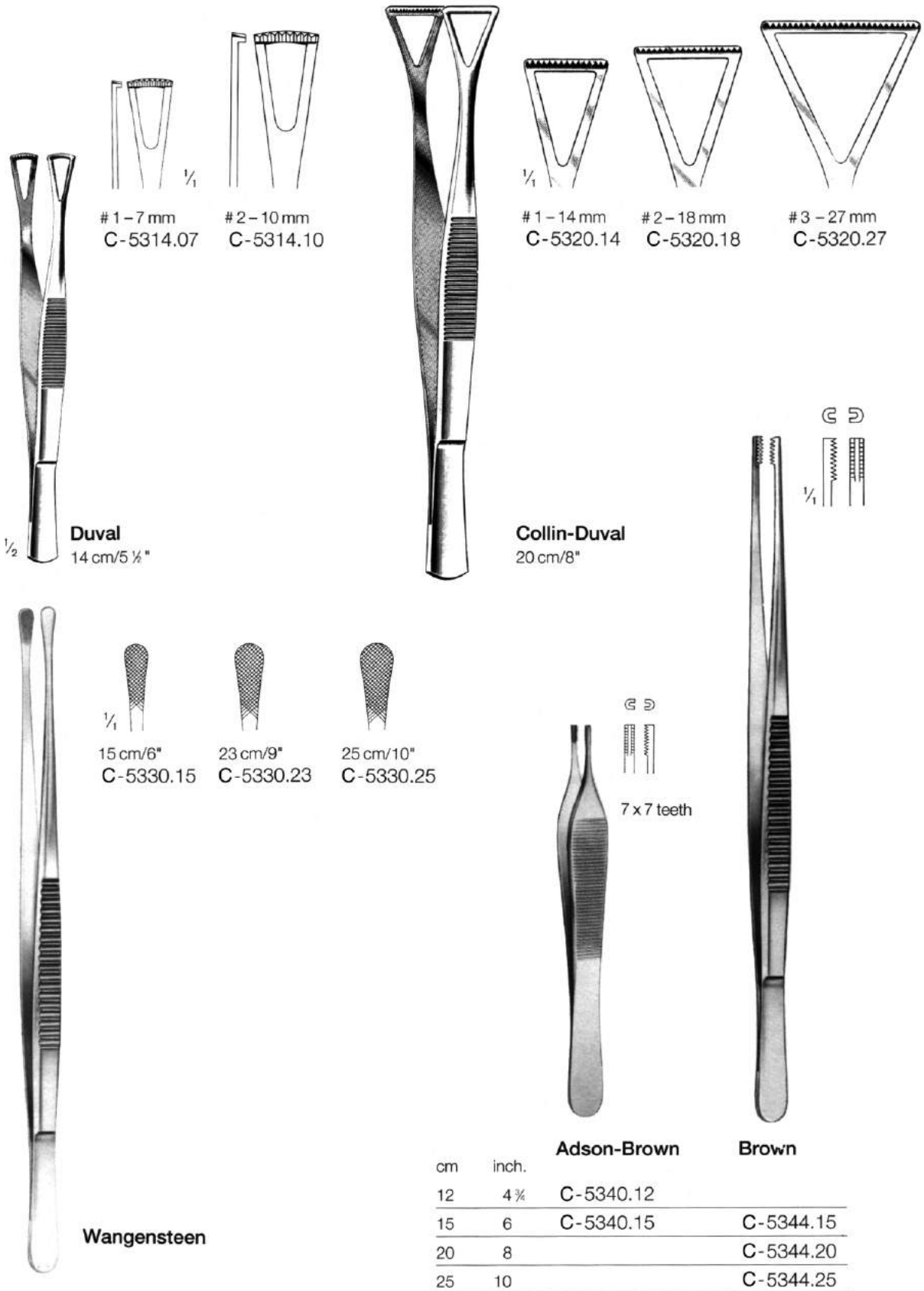

Approximation- and Clip Applying Forceps

with clip holder

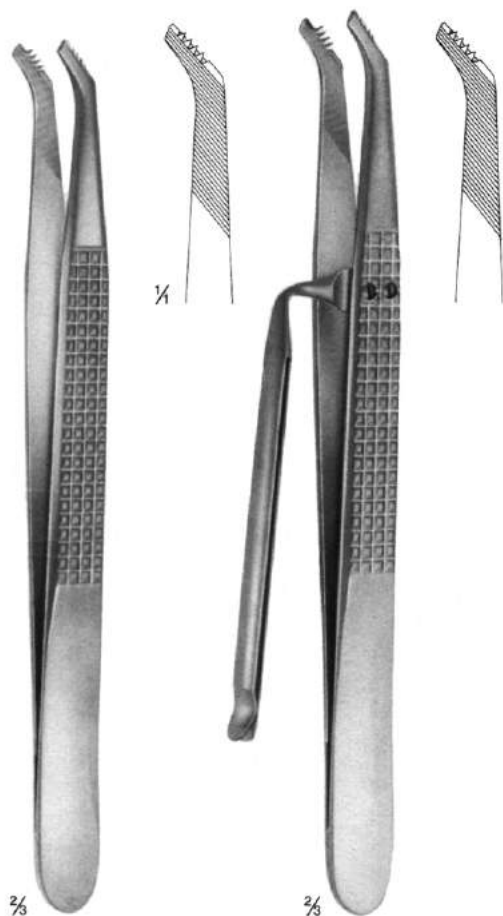

Childe
18 cm/7"
C-5710.18

Childe
18 cm/7"
C-5711.18



Michel
12 cm/4 3/4"
C-5720.12



Wachenfeldt
12 cm/4 3/4"
C-5730.12



Ochsner
14,5 cm/5 3/4"
C-5760-14

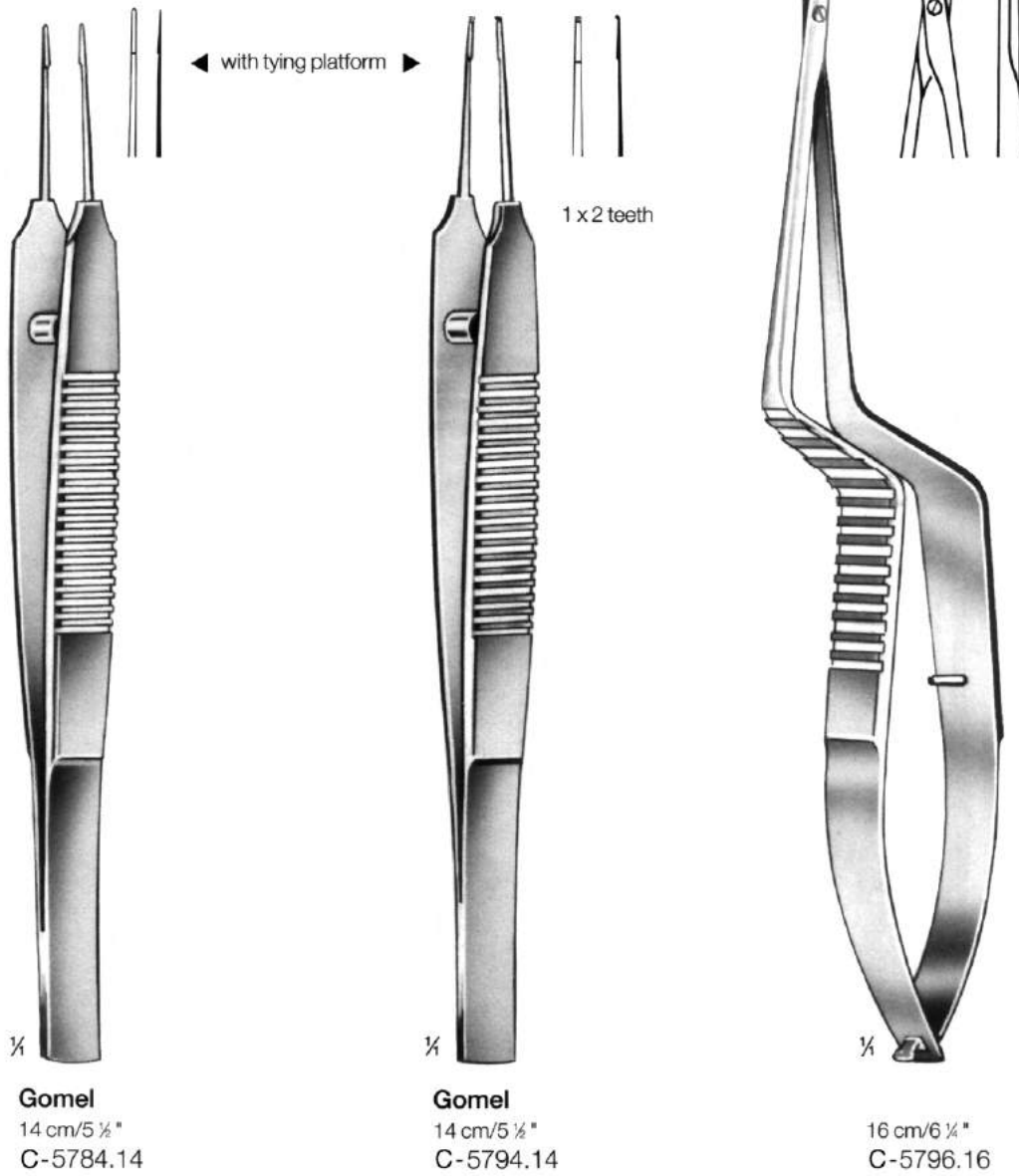

Hand Surgery – Tendon Grasping Forceps

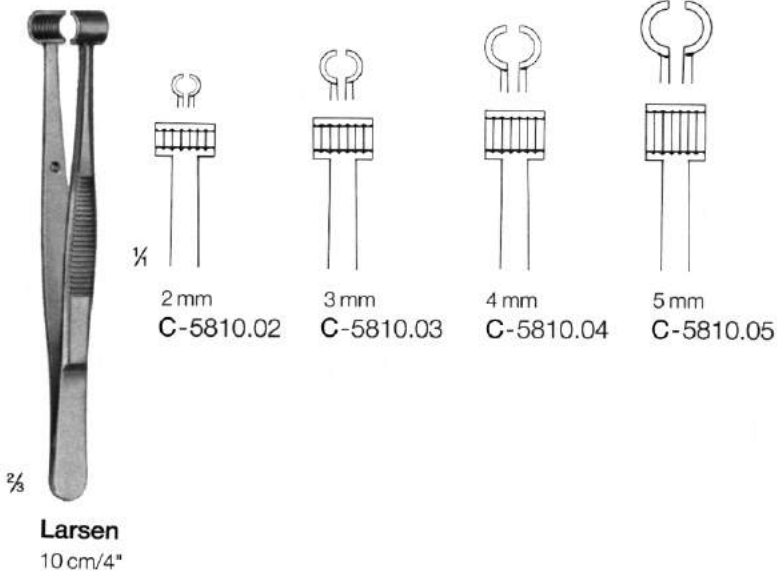

Sterilizing Forceps



Davis

cm	inch.	
16	6 $\frac{1}{4}$	C-5821.16
20	8	C-5821.20
24	9 $\frac{1}{2}$	C-5821.24



Kühne
 10,5 cm/4 $\frac{1}{4}$ "
 C-5841.10



No. 3
 11,5 cm/4 $\frac{1}{2}$ "
 C-5863.11



No. 4
 11 cm/4 $\frac{1}{4}$ "
 C-5864.11



No. 5
 11 cm/4 $\frac{1}{4}$ "
 C-5865.11



No. 7
 11,5 cm/4 $\frac{1}{2}$ "
 C-5867.11



Feilchenfeld

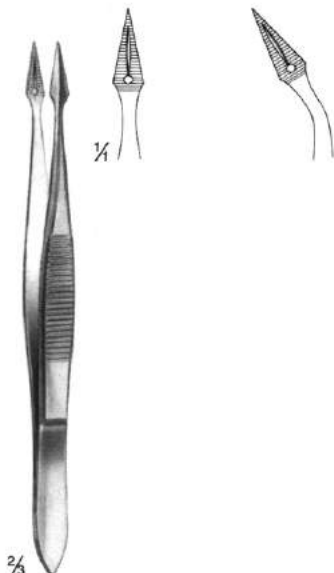

Hunter

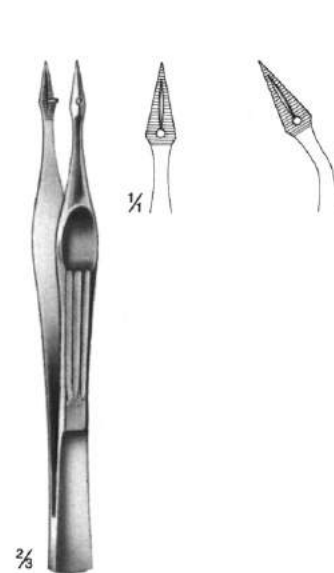

Walter-Carmalt

cm	inch.				
7,5	3	C-5902.07			
9	3 ½	C-5902.09			
10,5	4 ¼		C-5906.10	C-5907.10	C-5908.10 C-5909.10
11,5	4 ½	C-5902.11			

with guide pin

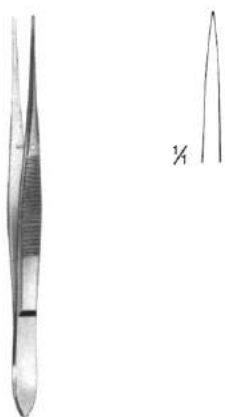

cm	inch.				
8	3 ¼	C-5920.08	C-5921.08	C-5922.08	C-5923.08
9	3 ½	C-5920.09	C-5921.09	C-5922.09	C-5923.09
10,5	4 ¼	C-5920.10	C-5921.10	C-5922.10	C-5923.10
11,5	4 ½	C-5920.11	C-5921.11	C-5922.11	C-5923.11
12,5	5	C-5920.12	C-5921.12	C-5922.12	C-5923.12

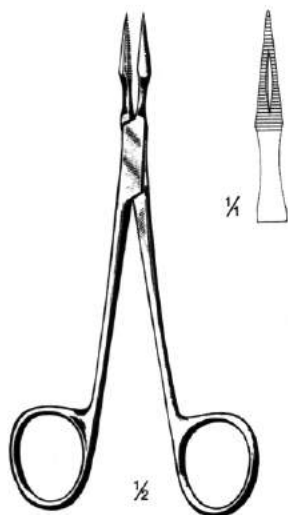

Arthur
14 cm/5 1/2"
C-5930.14

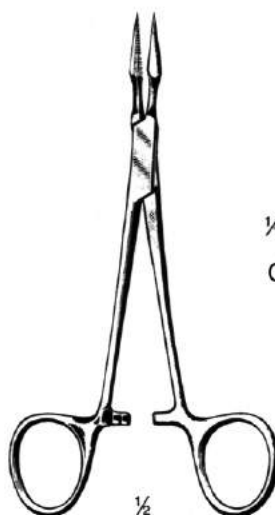

Stieglitz (Williams)
14 cm/5 1/2"

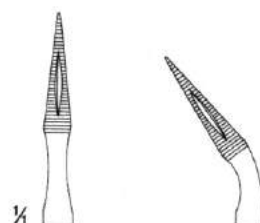

C-5932.14

C-5933.14

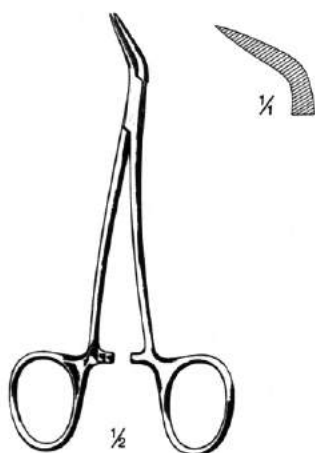

Peet
11,5 cm/4 1/2"
C-5935.11



Ralks (Virtus)
15 cm/6"

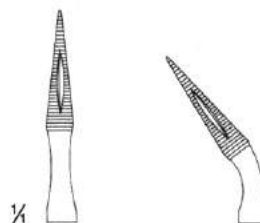

C-5938.15

C-5939.15

Ear and nasal dressing forceps
Pinces auriculaires et nasaux
Pinzas auriculares y nasales

Columella Forceps



1/2

Masing
 8,5 cm/3 3/8"
 C-5402.85



1/2

Cottle
 11 cm/4 3/8"
 C-5404.11

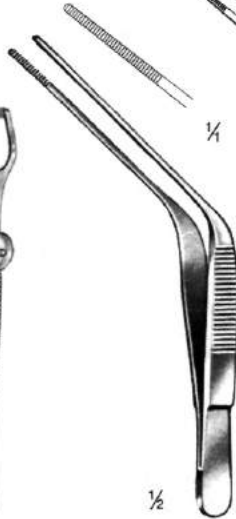

1/2

Troeltsch (Wilde)
 11 cm/4 1/2"
 C-5607.11



1/2

Troeltsch (Wilde)
 13 cm/5"
 C-5607.13



1/2

Troeltsch
 15 cm/6"
 C-5607.15



1/2

Troeltsch
 13 cm/5"
 C-5611.13



1/2

Lucae
 14 cm/5 1/2"
 C-5655.14



Jansen
 16 cm/6 1/4"
 C-5655.16



Jansen
 19 cm/7 1/2"
 C-5655.19



Lucae
 14 cm/5 1/2"
 C-5663.14



Jansen
 16 cm/6 1/4"
 C-5663.16

1 x 2 Zähne
 1 x 2 teeth
 1 x 2 dientes
 1 x 2 dents

1 x 2 teeth

Iris Forceps

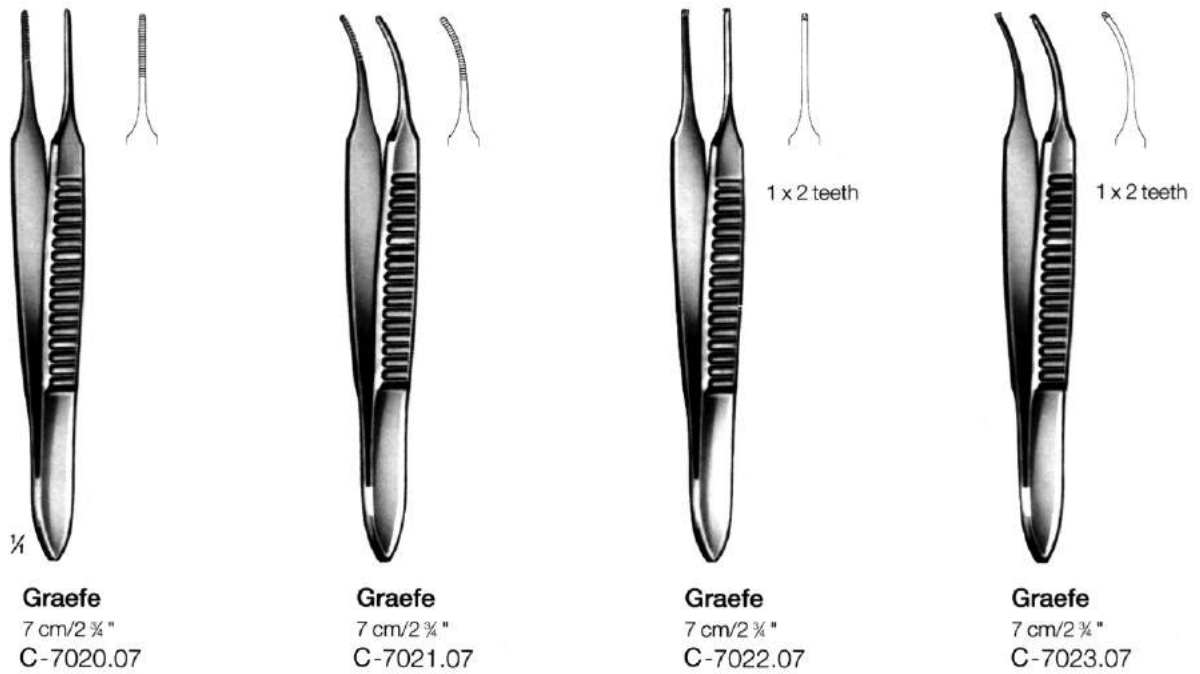
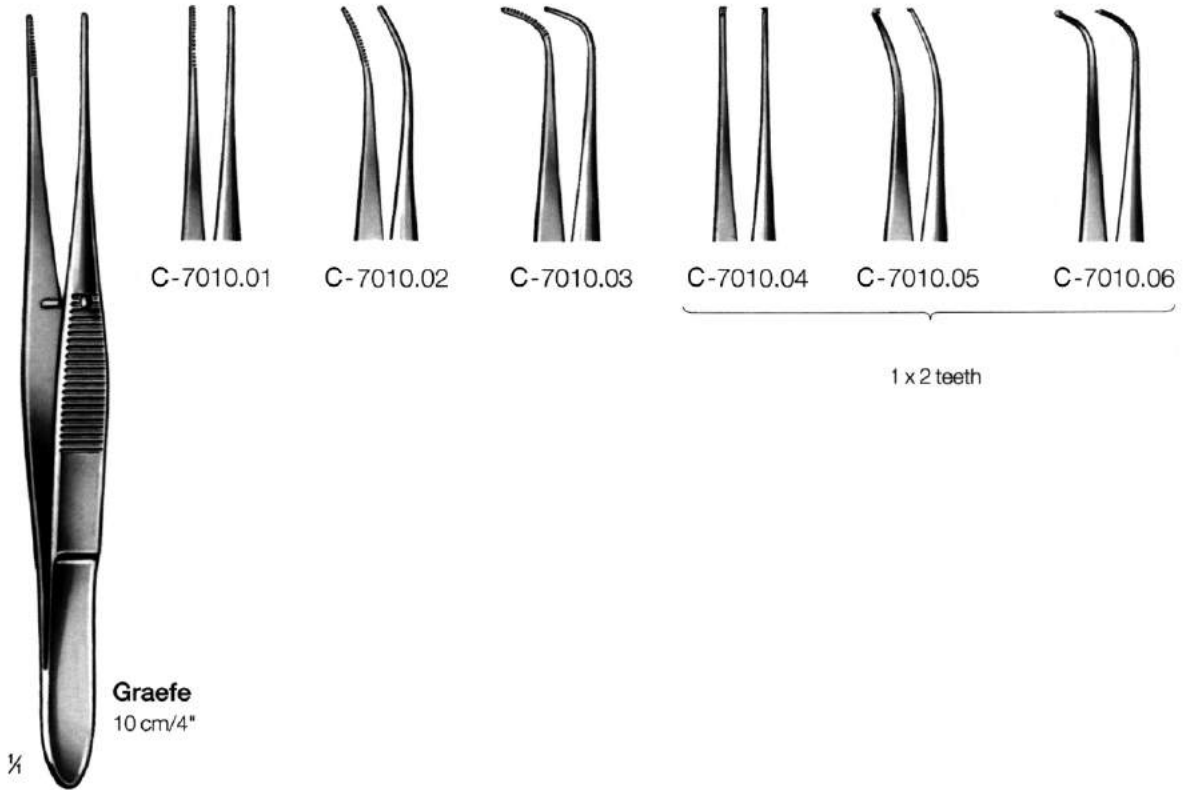



D



- Clamps and forceps
- Pinces et pinces-clamps
- Pinzas y pinzas-clamps



Dieffenbach

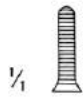

38 mm/1 1/2"
D-0010.38



38 mm/1 1/2"
D-0011.38



51 mm/2"
D-0010.51



51 mm/2"
D-0011.51



60 mm/2 1/2"
D-0014.60



60 mm/2 1/2"
D-0015.60



Johns-Hopkins



38 mm/1 1/2"
D-0031.38



51 mm/2"
D-0031.51



57 mm/2 1/4"
D-0031.57



63 mm/2 1/2"
D-0031.63



70 mm/2 3/4"
D-0031.70



75 mm/3"
D-0031.75



90 mm/3 1/2"
D-0031.90

Featherlight Bulldog Clamps



D-0044.31



D-0044.35



D-0044.39



D-0045.30



D-0045.33



D-0045.36

	D-0044.31	D-0044.35	D-0044.39	D-0045.30	D-0045.33	D-0045.36
Length	31 mm	35 mm	39 mm	30 mm	33 mm	36 mm
Jaws	10 mm	14 mm	18 mm	10 mm	14 mm	18 mm
Weight	1gr.	1gr.	1gr.	1gr.	1gr.	1gr.
Pressure	30 gr.	30 gr.	30 gr.	30 gr.	30 gr.	30 gr.



Diethrich

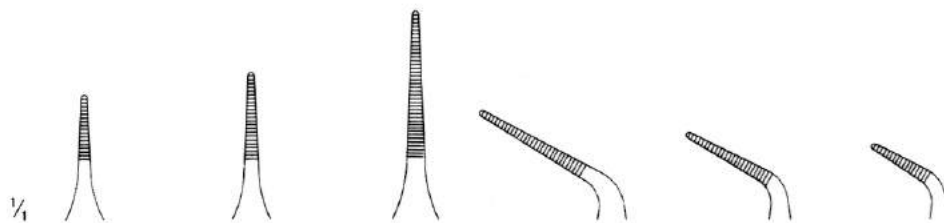

	D-0050.49	D-0050.53	D-0050.59	D-0051.43	D-0051.45	D-0051.50
Length	49 mm	53 mm	59 mm	43 mm	45 mm	50 mm
Jaws	8 mm	12 mm	20 mm	8 mm	12 mm	20 mm
Weight	3 gr.	3 gr.	3 gr.	3 gr.	3 gr.	3 gr.
Pressure	80 gr.	80 gr.	80 gr.	80 gr.	80 gr.	80 gr.



Diethrich

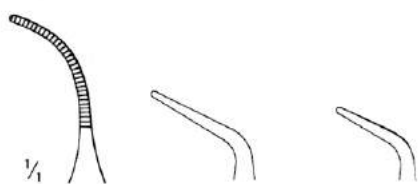

	D-0053.54	D-0055.43	D-0055.49
Length	54 mm	43 mm	49 mm
Jaws	20 mm	13 mm	18 mm
Weight	3 gr.	3 gr.	3 gr.
Pressure	80 gr.	80 gr.	80 gr.



DeBakey-Diethrich



	D-0056.47	D-0056.51	D-0056.57
Length	47 mm	51 mm	57 mm
Jaws	10 mm	14 mm	20 mm
Weight	3 gr.	3 gr.	3 gr.
Pressure	180 gr.	180 gr.	180 gr.



	D-0057.44	D-0057.46	D-0057.49	D-0059.54
Length	44 mm	46 mm	49 mm	54 mm
Jaws	10 mm	14 mm	20 mm	20 mm
Weight	3 gr.	3 gr.	3 gr.	3 gr.
Pressure	180 gr.	180 gr.	180 gr.	180 gr.

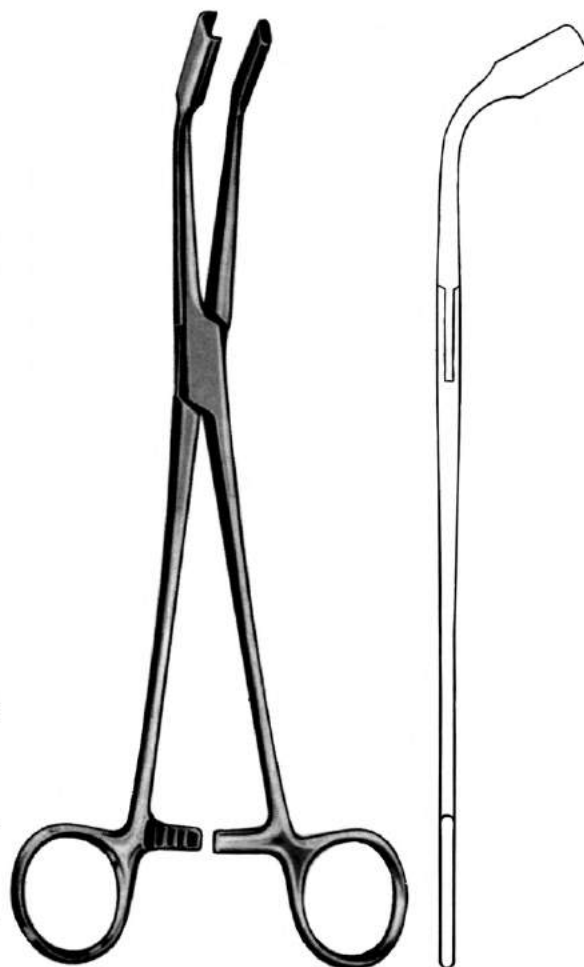

Johns-Hopkins
 23 cm/9"
 D-0090.23

Mini bulldog clamps
Mini-clamps bulldog
Mini-clamps bulldog



	D-0064.49	D-0064.54	D-0064.61
	49 mm	54 mm	61 mm
	13 mm	18 mm	25 mm



Wickham Mini

Weight 3 gr.

Pressure 150 gr.

	D-0065.47	D-0065.51	D-0065.55
Length	47 mm	51 mm	55 mm
Jaws	13 mm	18 mm	25 mm

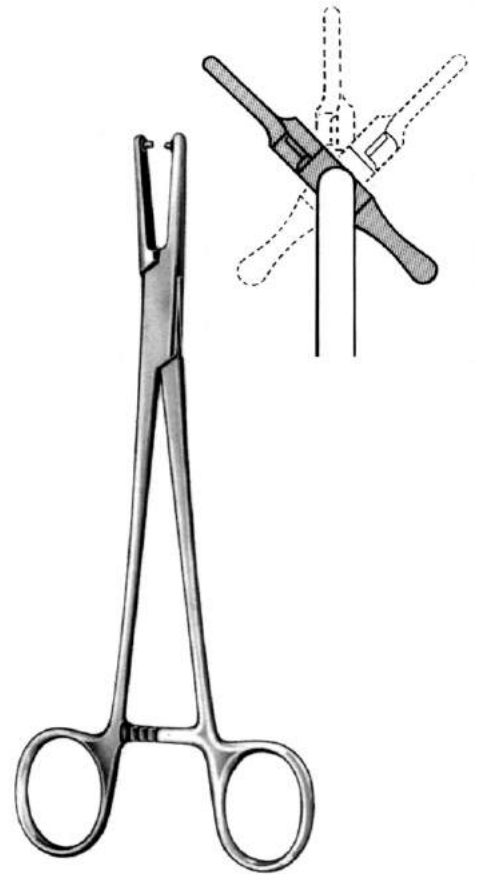

Wickham
 24 cm/9 1/2"
 D-0092.24

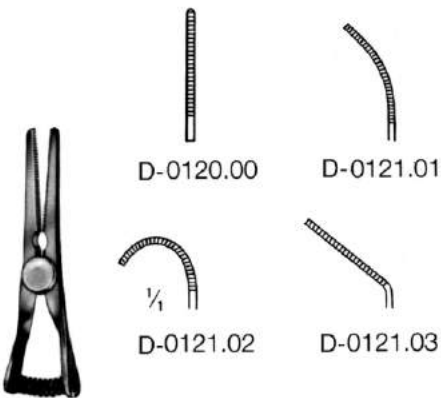

Mini-Glover (Weldon)

Overall length (mm)	Jaw length (mm)	Weight (g)
35	14	12

Mini bulldog clamps
 Mini-clamps bulldog
 Mini-clamps bulldog



DeBakey

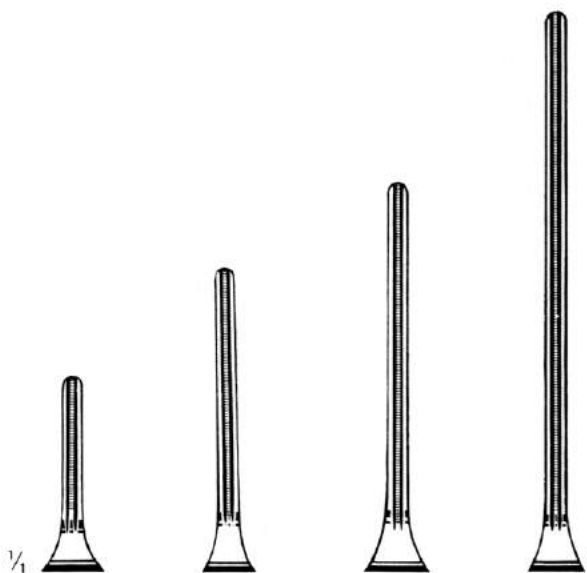

	D-0070.08	D-0070.09	D-0070.10	D-0070.12
Overall length	80 mm	90 mm	105 mm	125 mm
Jaw length	20 mm	30 mm	45 mm	68 mm
Weight	10 gr.	11 gr.	12 gr.	14 gr.



DeBakey

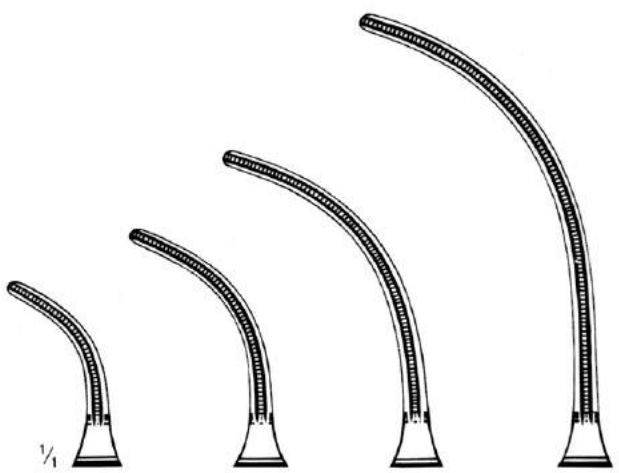

	D-0071.08	D-0071.09	D-0071.10	D-0071.12
Overall length	75 mm	85 mm	95 mm	115 mm
Jaw length	20 mm	30 mm	45 mm	68 mm
Weight	10 gr.	11 gr.	12 gr.	14 gr.

Mini bulldog clamps
Mini-clamps bulldog
Mini-clamps bulldog

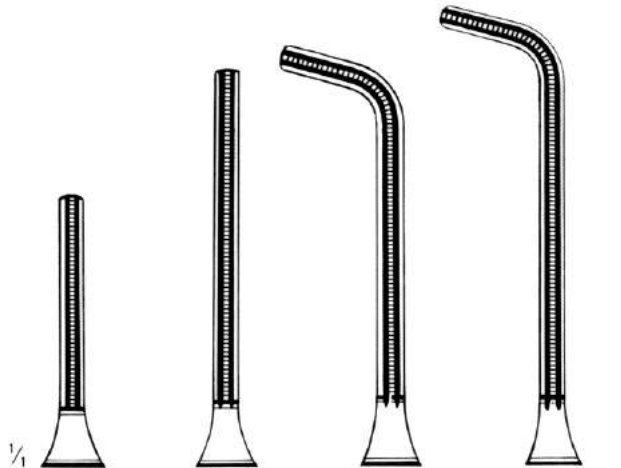

	D-0076.09	D-0076.11	D-0077.10	D-0077.11
Overall length	90 mm	110 mm	105 mm	110 mm
Jaw length	27 mm	44 mm	55 mm	60 mm
Weight	11 gr.	12 gr.	12 gr.	12 gr.

"Soft" Bulldog Clamps

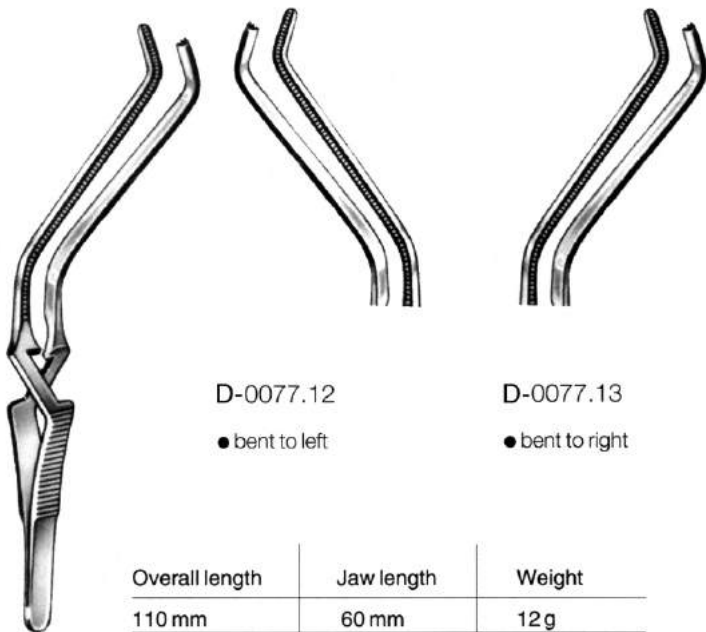

D-0077.12

● bent to left

D-0077.13

● bent to right

Overall length	Jaw length	Weight
110 mm	60 mm	12 g

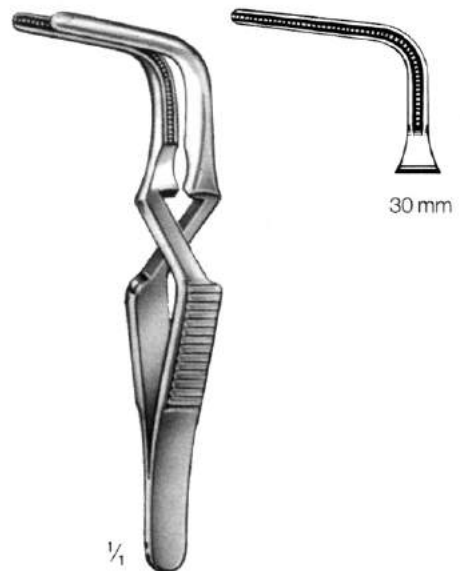

1/4

Santulli
 7 cm 2 3/4"
 D-0071.70



Glover

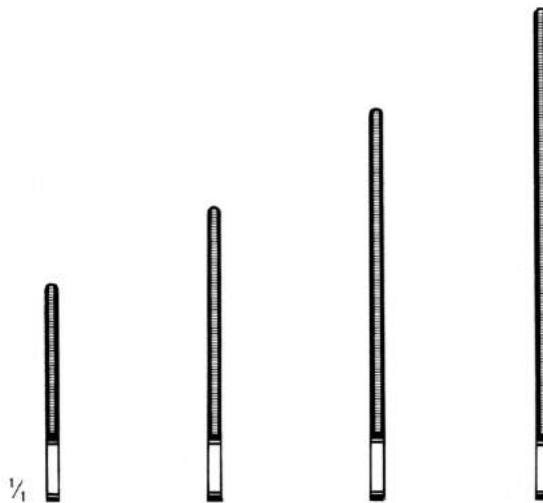

	D-0150.05	D-0150.07	D-0150.09	D-0150.11
Overall length	50 mm	68 mm	85 mm	105 mm
Jaw length	20 mm	30 mm	43 mm	56 mm
Weight	5 gr.	9 gr.	12 gr.	14 gr.

Closing pressure adjustable

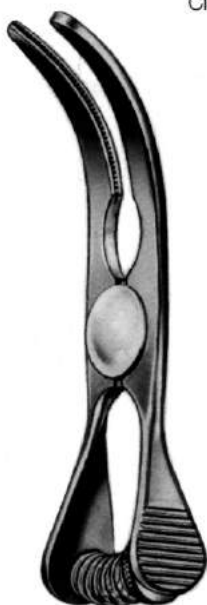

Glover

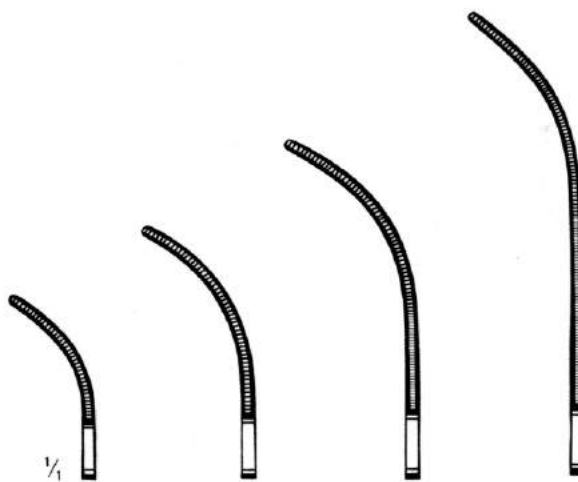

	D-0151.05	D-0151.07	D-0151.08	D-0151.10
Overall length	46 mm	64 mm	78 mm	100 mm
Jaw length	20 mm	30 mm	43 mm	56 mm
Weight	5 gr.	9 gr.	12 gr.	14 gr.

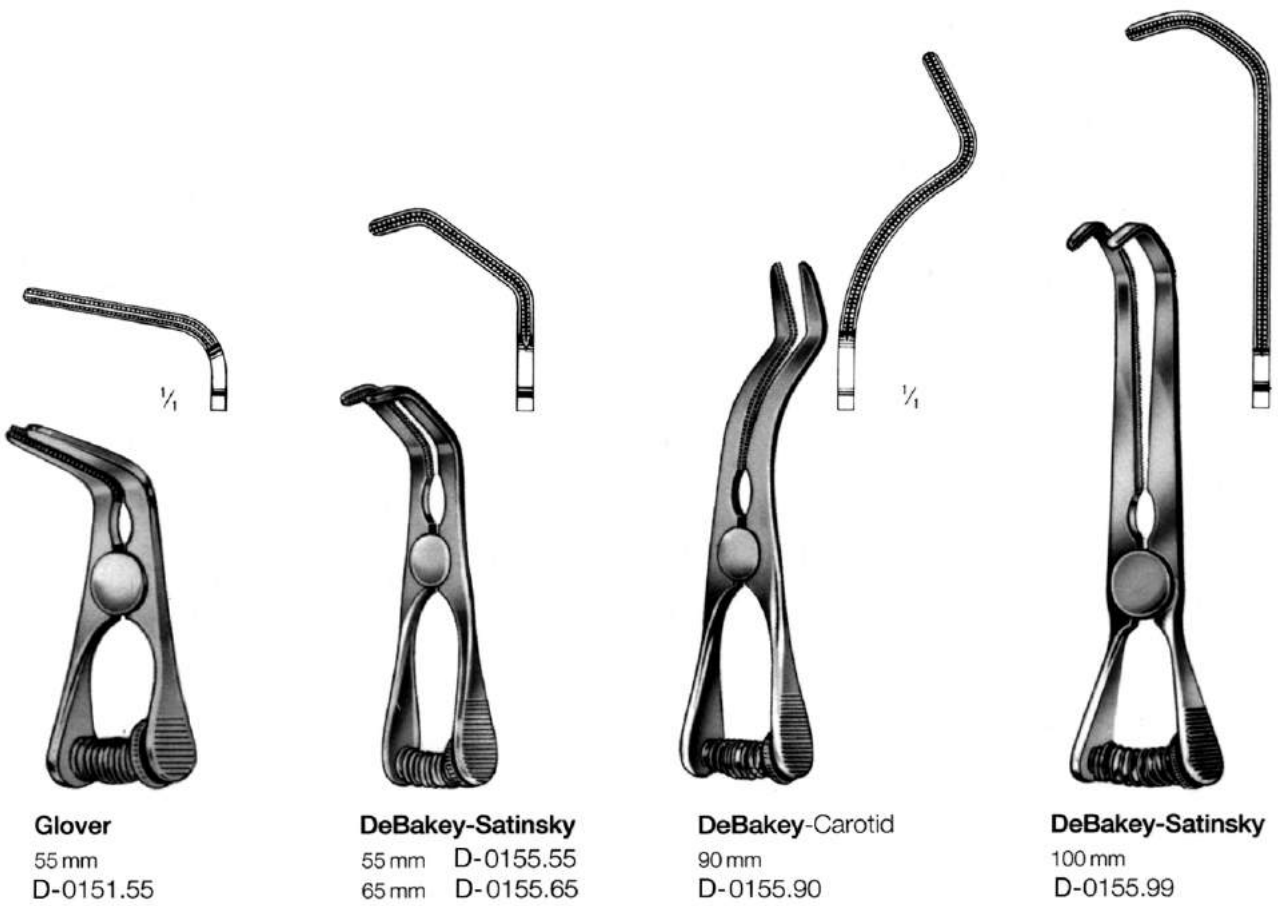



Schwartz
 19 cm/7 1/2"
 D-570.19



D-571/01



D-571/02



D-571/03

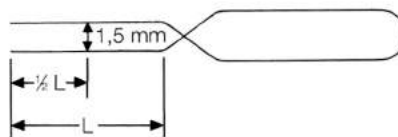

Fine hemostatic forceps
Pinces hémostatiques fins
Pinzas hemostáticas finas



**Hartmann
 (Baby-Mosquito)**
 9,5 cm/3 7/8"

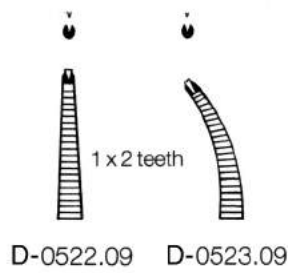
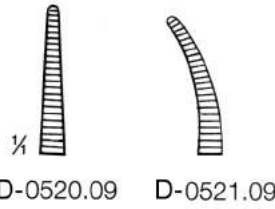

Micro-Mosquito

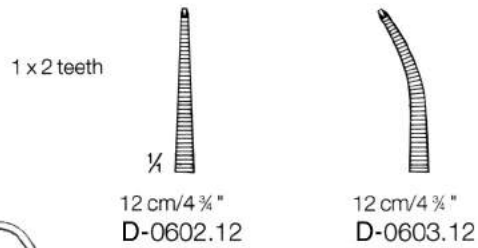
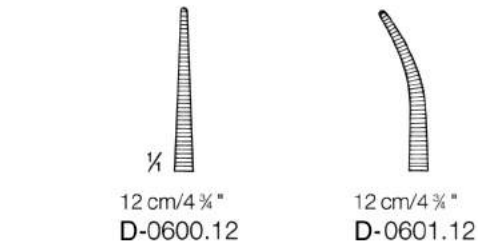

Fine hemostatic forceps
Pinces hémostatiques fins
Pinzas hemostáticas finas

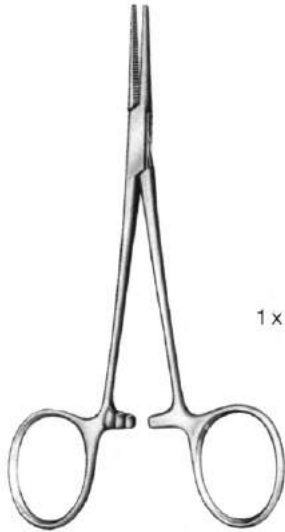

Halsted-Mosquito

1 x 2 teeth



12,5 cm/5"
D-0620.12



14 cm/5 1/2"
D-0620.14



12,5 cm/5"
D-0621.12



14 cm/5 1/2"
D-0621.14



12,5 cm/5"
D-0622.12



14 cm/5 1/2"
D-0622.14



12,5 cm/5"
D-0623.12



14 cm/5 1/2"
D-0623.14



Halsted-Mosquito

1 x 2 teeth



18 cm/7"
D-0620.18



21 cm/8 1/4"
D-0620.21



18 cm/7"
D-0621.18



21 cm/8 1/4"
D-0621.21



18 cm/7"
D-0622.18



21 cm/8 1/4"
D-0622.21



18 cm/7"
D-0623.18



21 cm/8 1/4"
D-0623.21

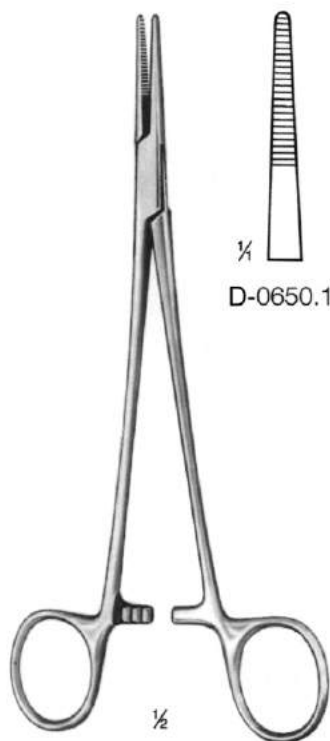

$\frac{1}{4}$
 D-0650.19

D-0651.19

$\frac{1}{2}$

Adson
 19 cm/7 $\frac{1}{2}$ "

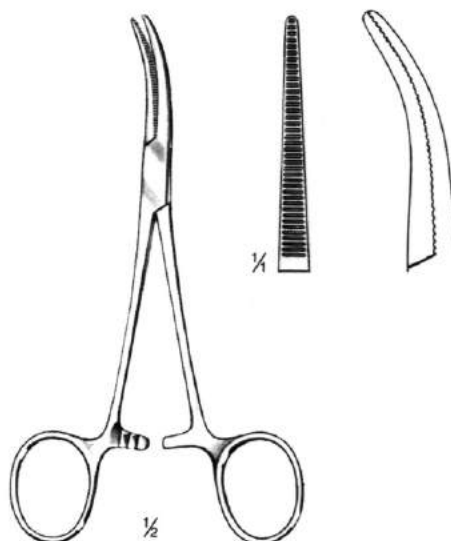

$\frac{1}{4}$

$\frac{1}{2}$

Dandy
 14 cm/5 $\frac{1}{2}$ "
 D-0671.14

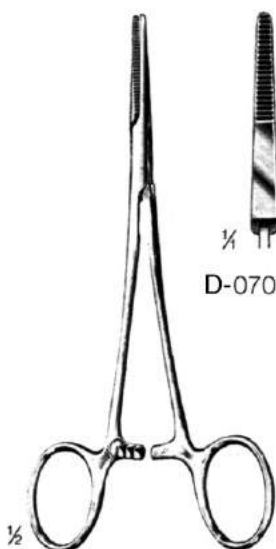

$\frac{1}{4}$
 D-0700.14

D-0701.14

$\frac{1}{2}$

Providence-Hospital
 14 cm/5 $\frac{1}{2}$ "

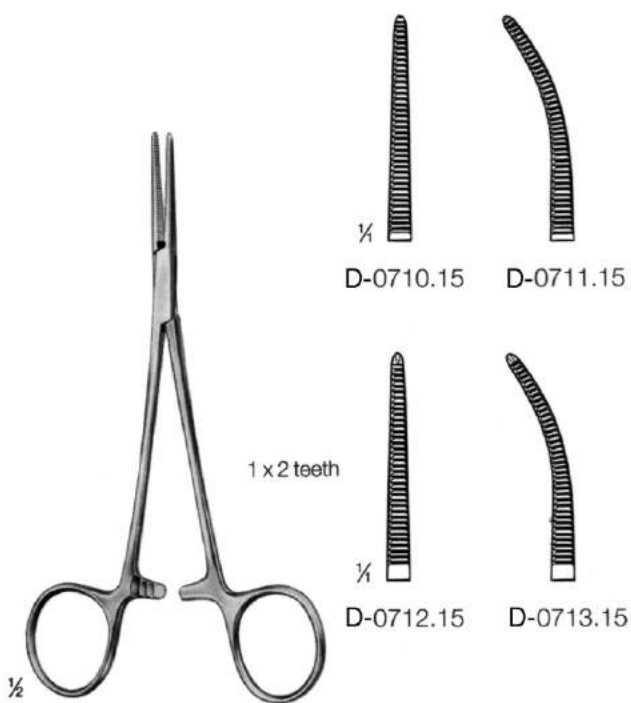

$\frac{1}{4}$
 D-0710.15

D-0711.15

1 x 2 teeth

$\frac{1}{4}$
 D-0712.15

D-0713.15

$\frac{1}{2}$

Leriche
 15 cm/6"

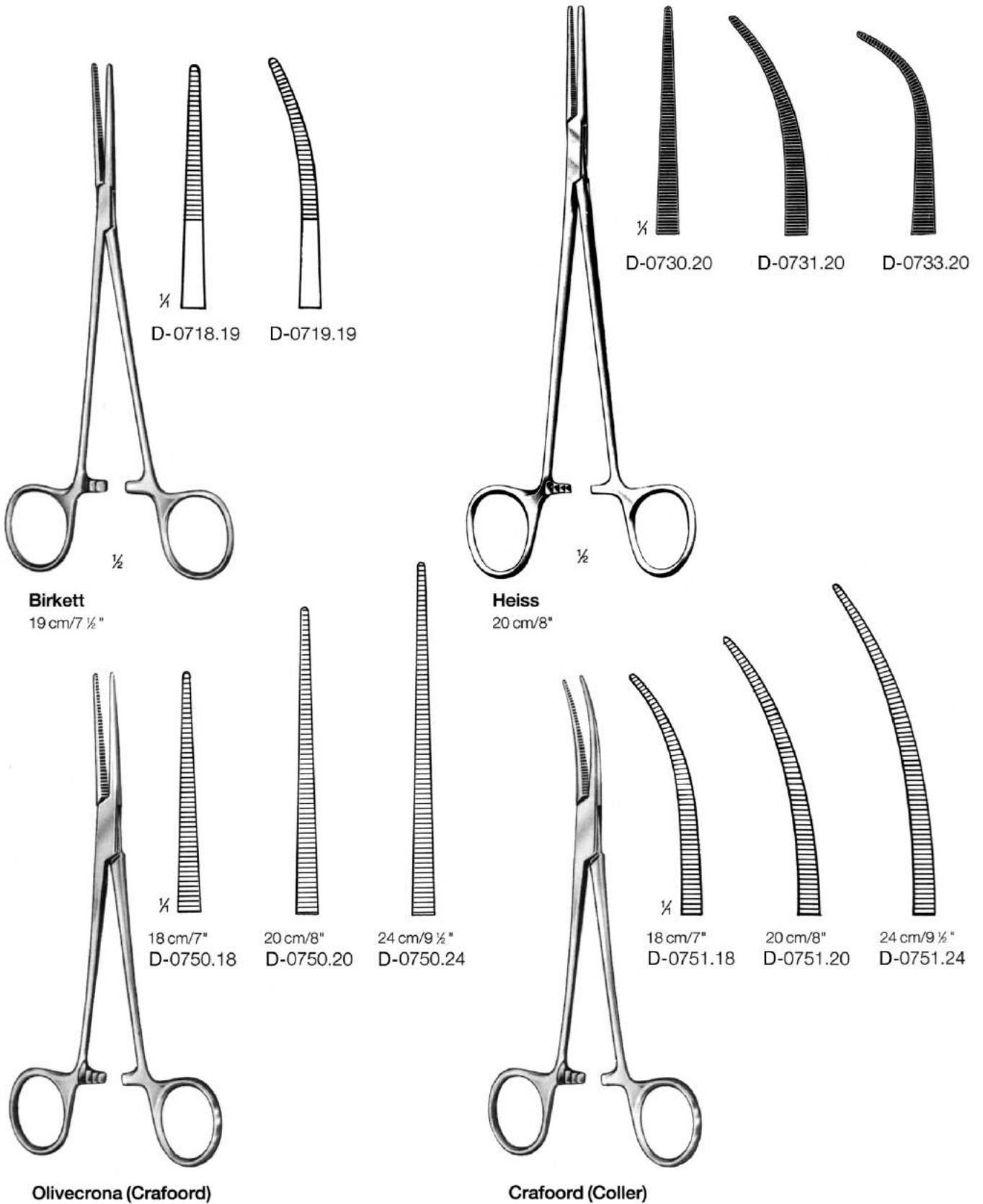

Fine hemostatic forceps
Pinces hémostatiques fins
Pinzas hemostáticas finas

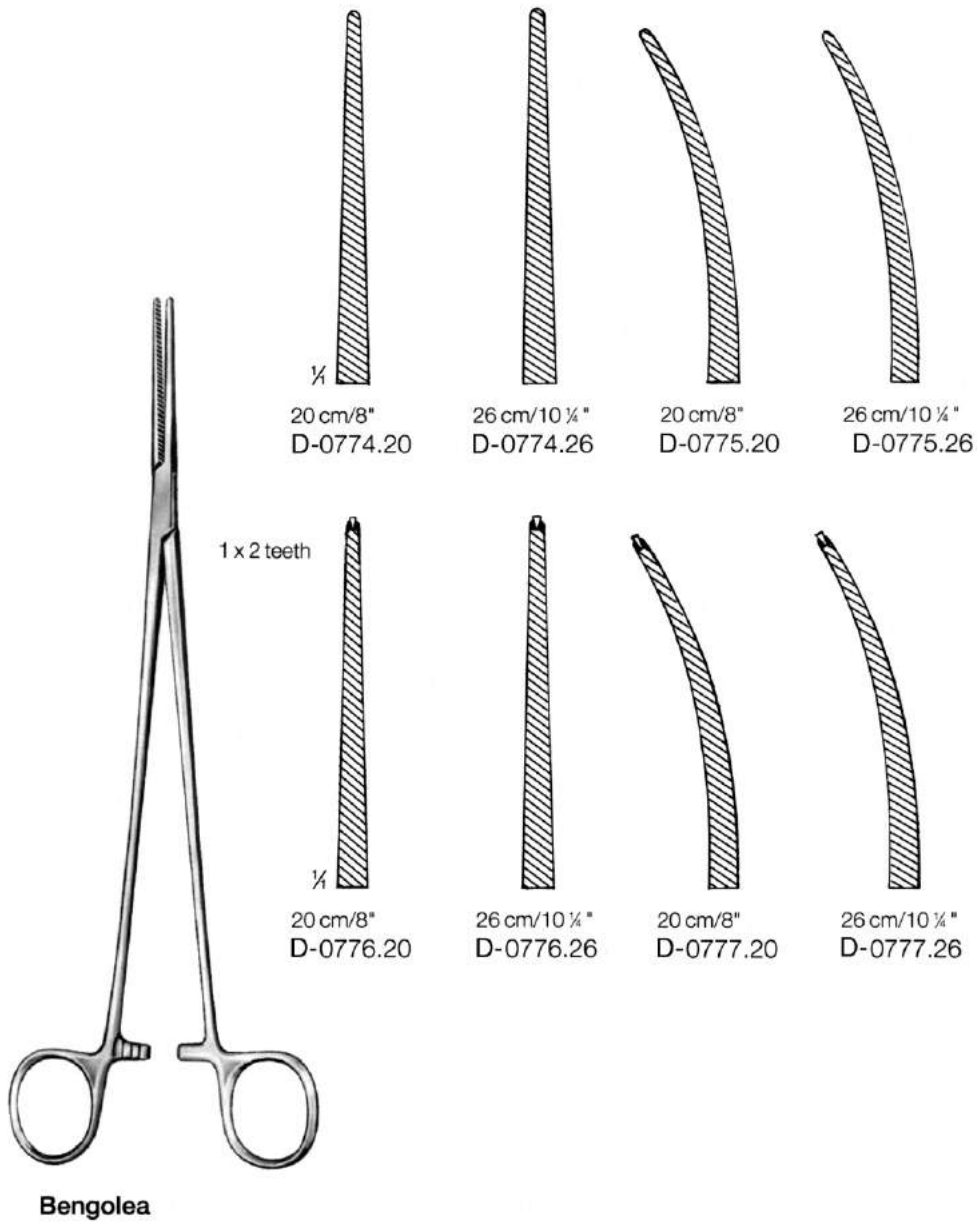

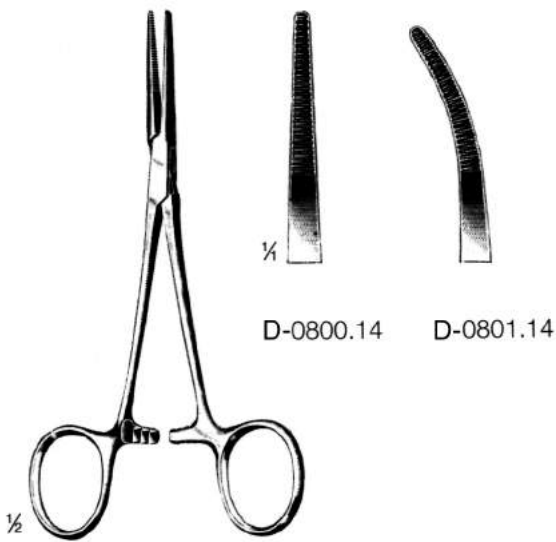

Kelly
 14 cm/5 $\frac{1}{2}$ "

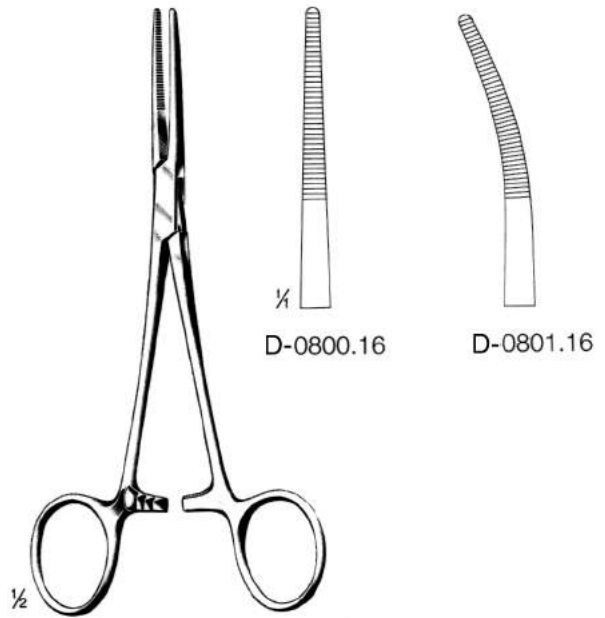

Rankin-Kelly
 16 cm/6 $\frac{1}{4}$ "

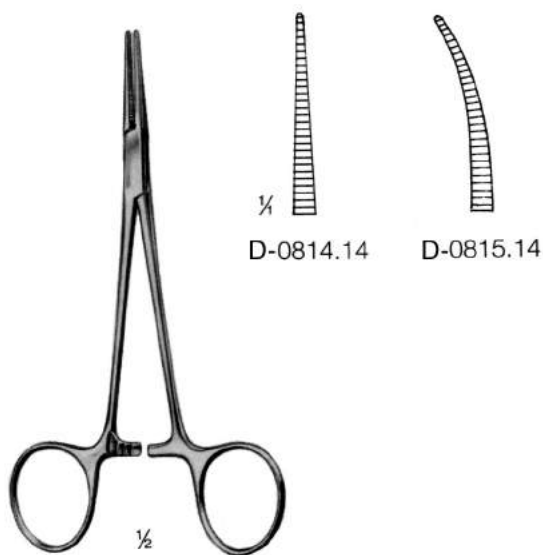

Baby-Crile
 14 cm/5 $\frac{1}{2}$ "

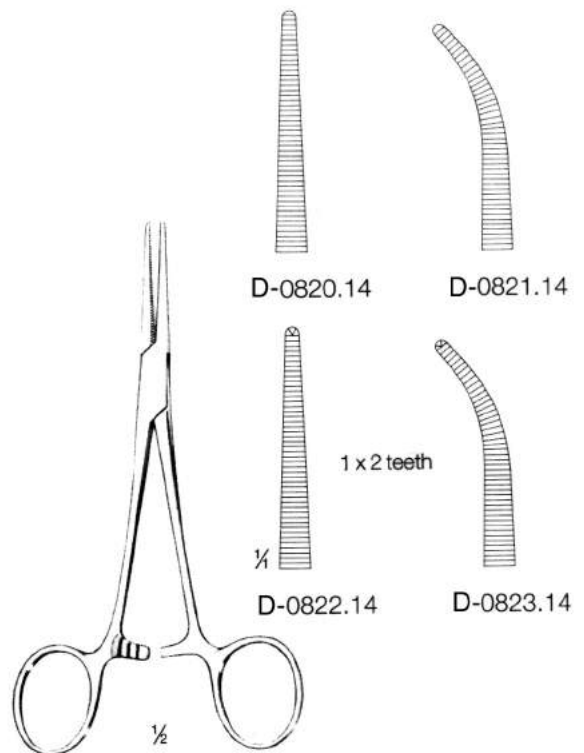

Crile
 14 cm/5 $\frac{1}{2}$ "

Hemostatic Forceps
Pinces hémostatiques
Pinzas hemostáticas



Rankin-Crile
 16 cm/6.25"

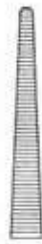

D-0820.16



D-0821.16

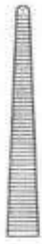

D-0822.16

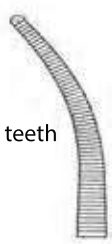

D-0823.16

1 x 2 teeth



Dunhill
 13 cm/5.2"



D-0830.13



D-0831.13

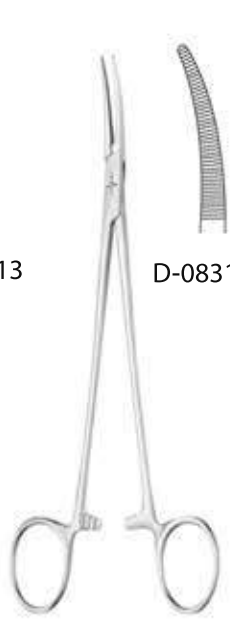

Fraser-Kelly
 18 cm/7"



D-0831.18

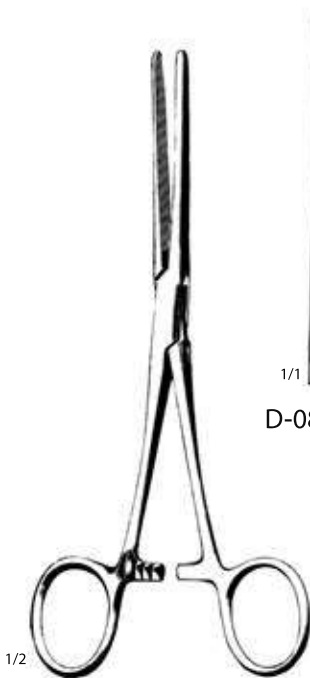

Bainbridge
 15 cm/6"



D-0840.15



D-0841.15

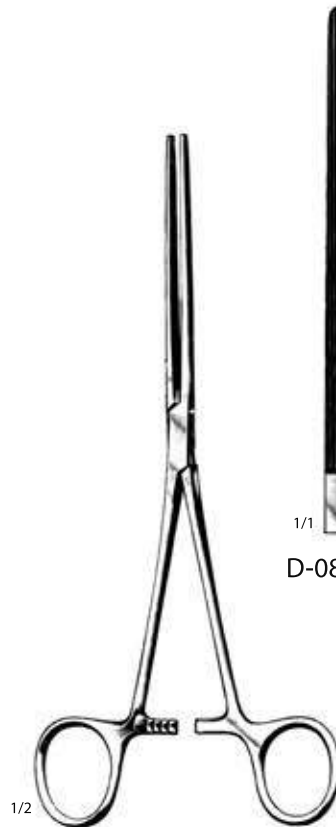

Bainbridge
 18.5 cm/7.25"



D-0840.18



D-0841.18



Rochester-Carmalt

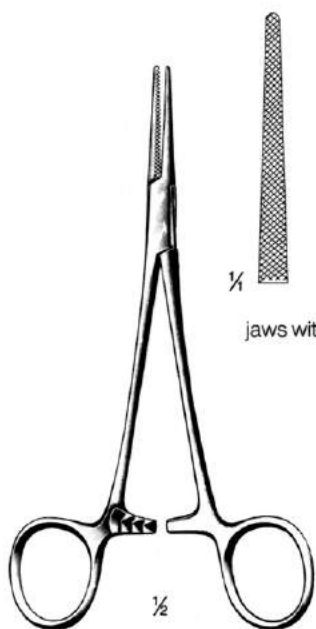
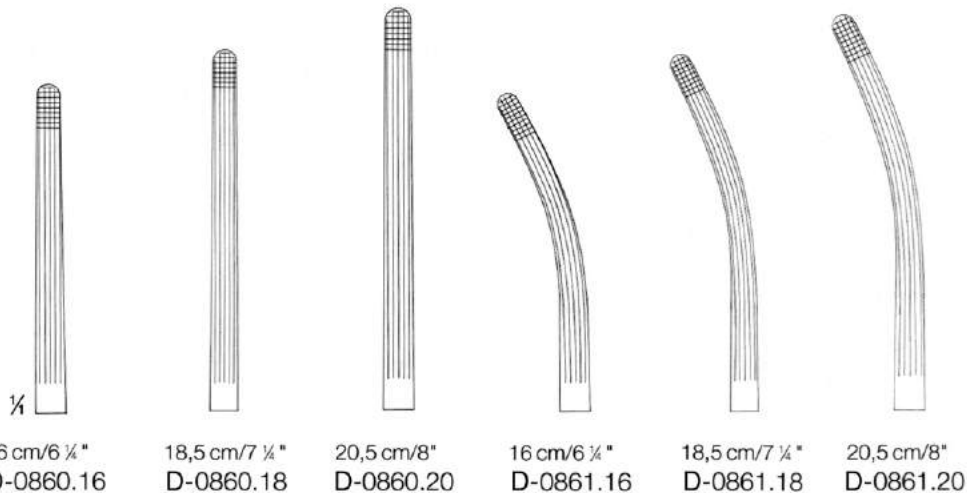

Dixon-Lovelace
 16 cm/6 ¼"
 D-0870.16

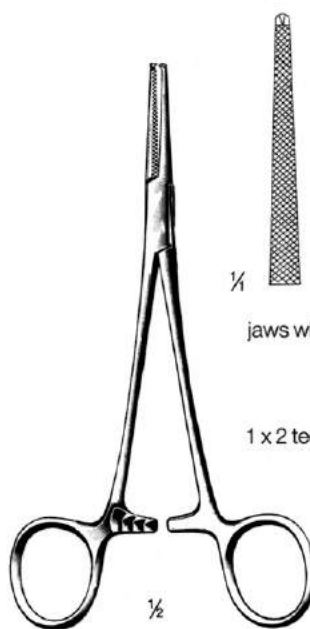
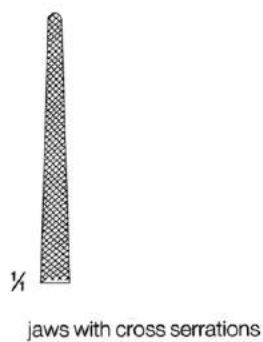

Dixon-Lovelace
 16 cm/6 ¼"
 D-0872.16

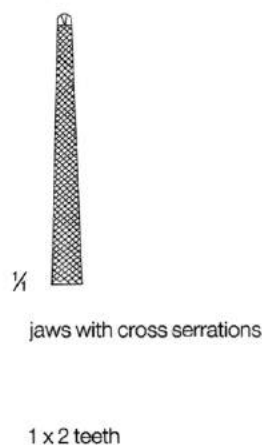

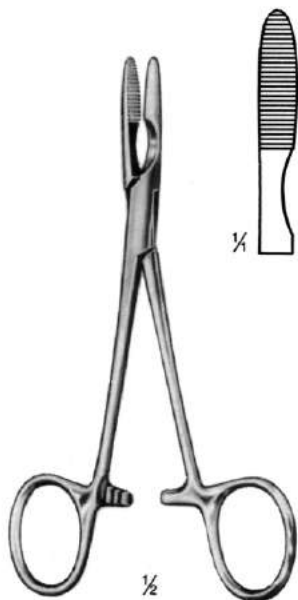

Péan
 14,5 cm/5 7/8"
 D-0920.14

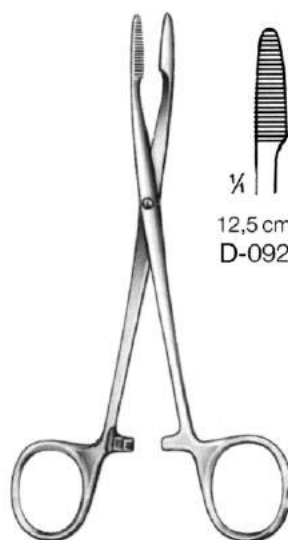

12,5 cm/5"
 D-0924.12

14 cm/5 1/2"
 D-0924.14

16 cm/6 1/4"
 D-0924.16



Péan

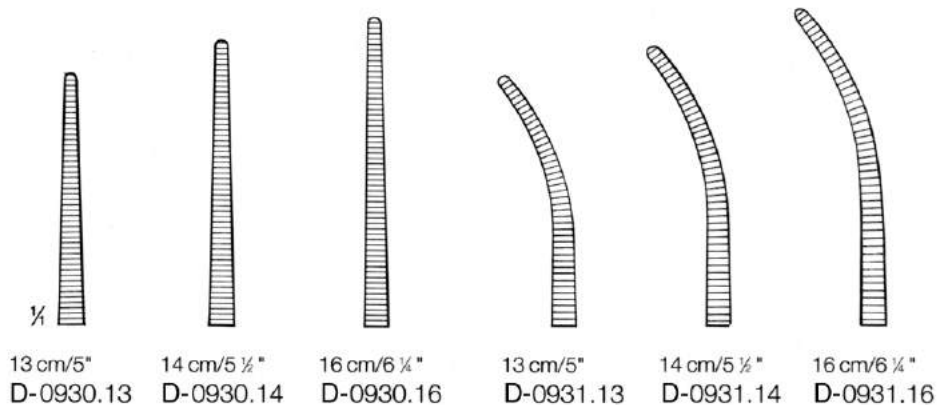

13 cm/5"
 D-0930.13

14 cm/5 1/2"
 D-0930.14

16 cm/6 1/4"
 D-0930.16

13 cm/5"
 D-0931.13

14 cm/5 1/2"
 D-0931.14

16 cm/6 1/4"
 D-0931.16

Delicate pattern

Hemostatic forceps
Pinces hémostatiques
Pinzas hemostáticas

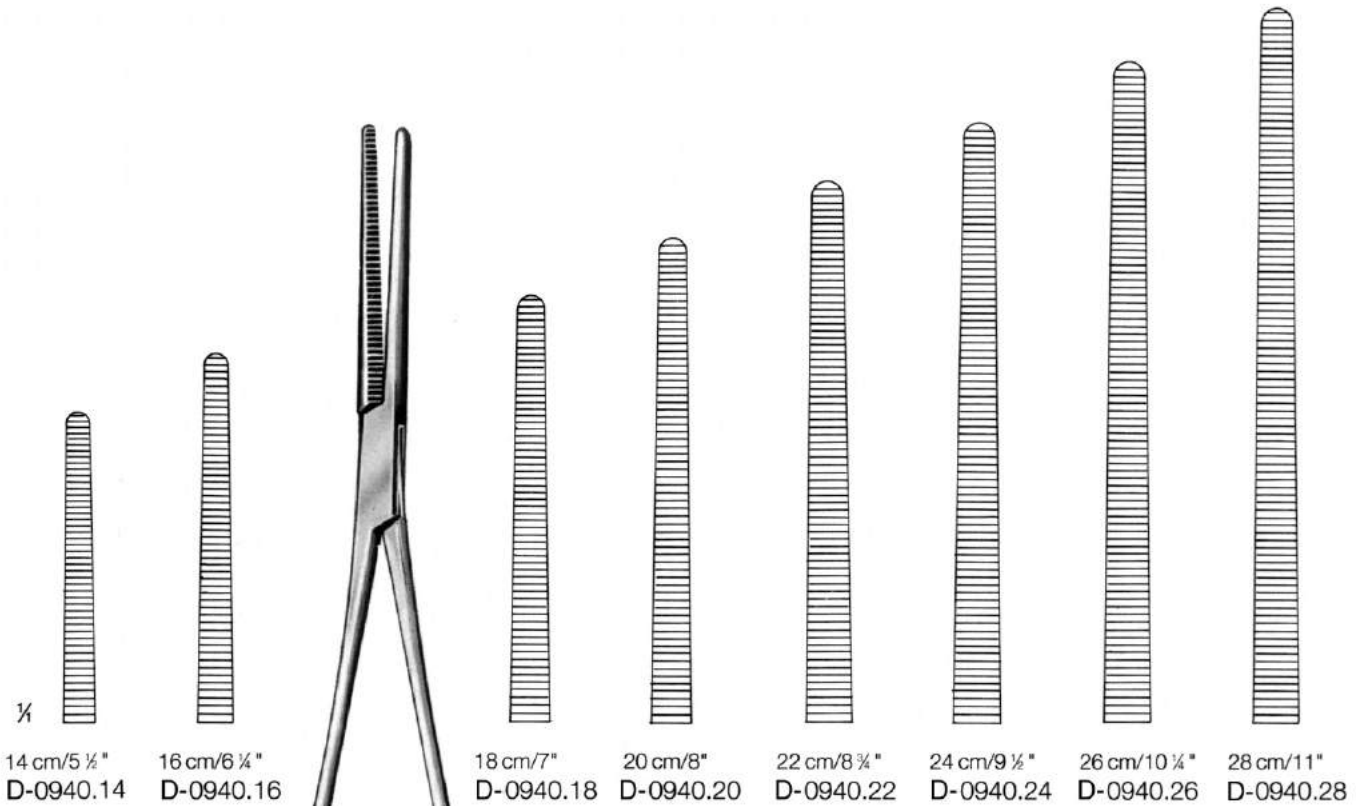

Rochester-Péan

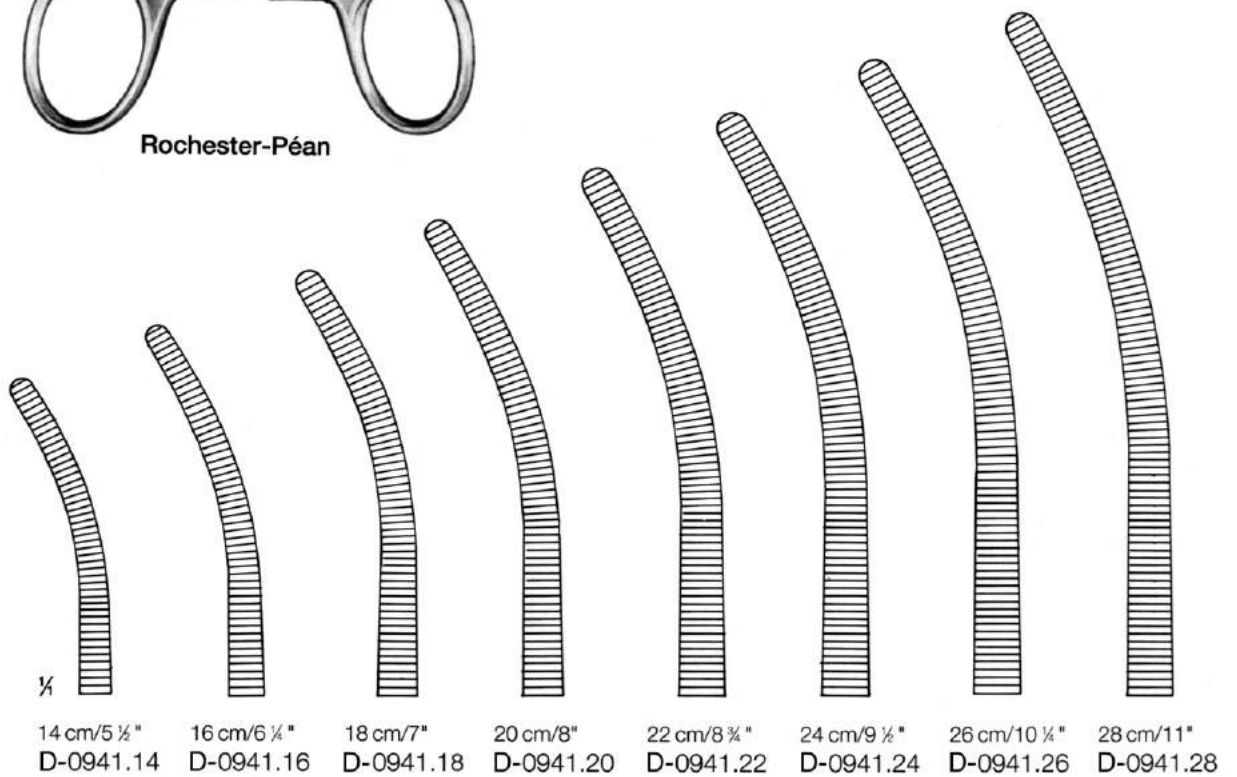

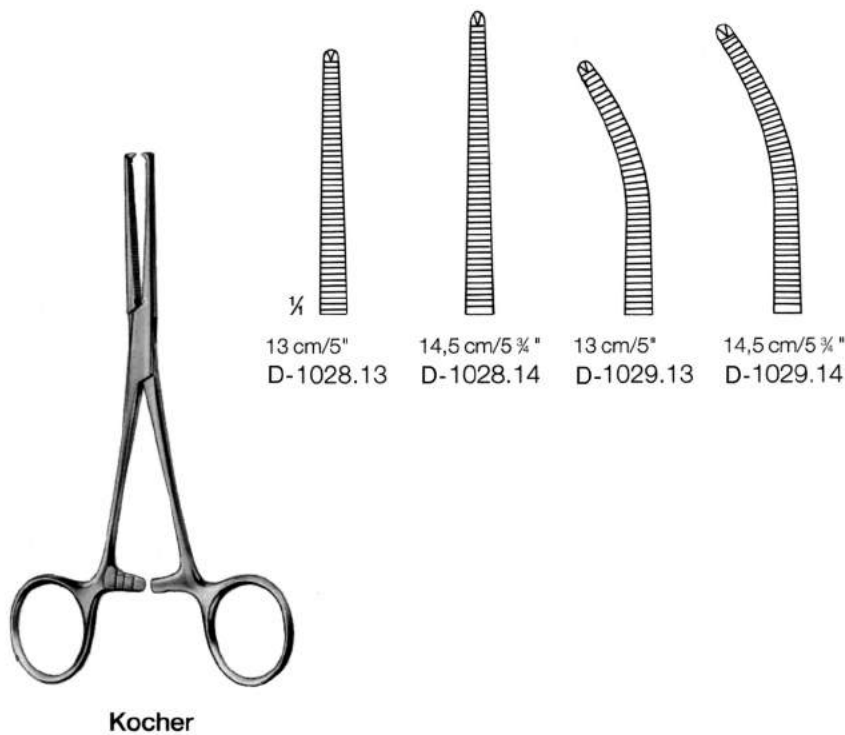
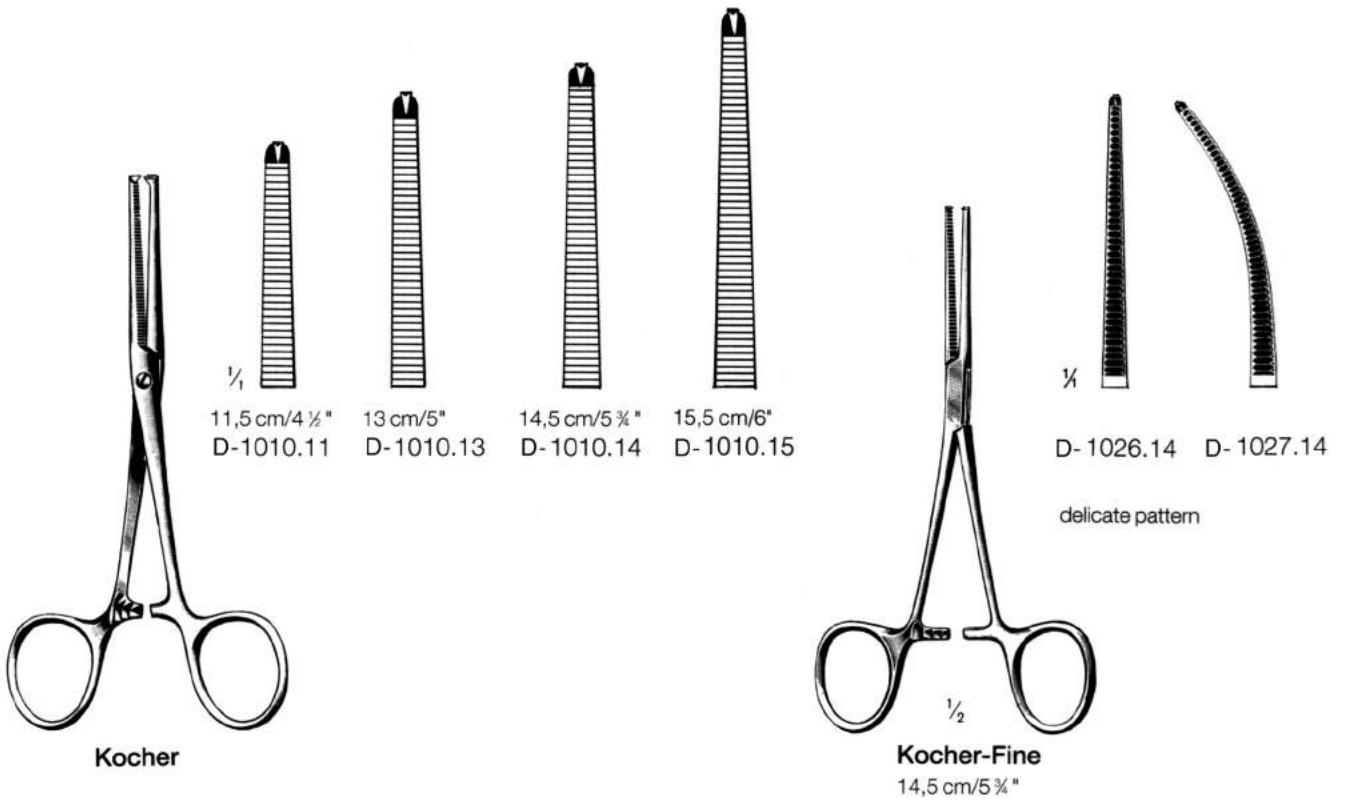

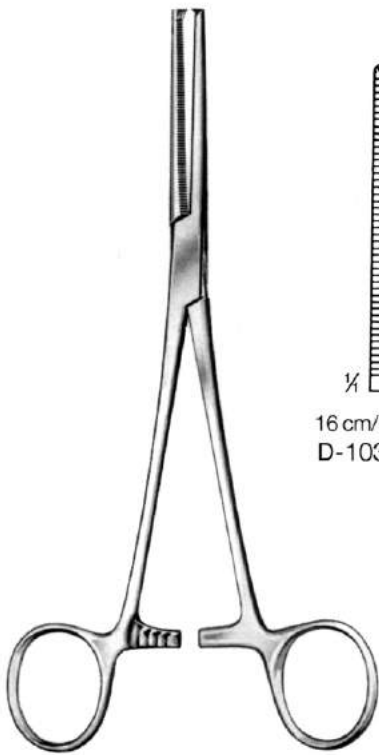

Rochester-Ochsner

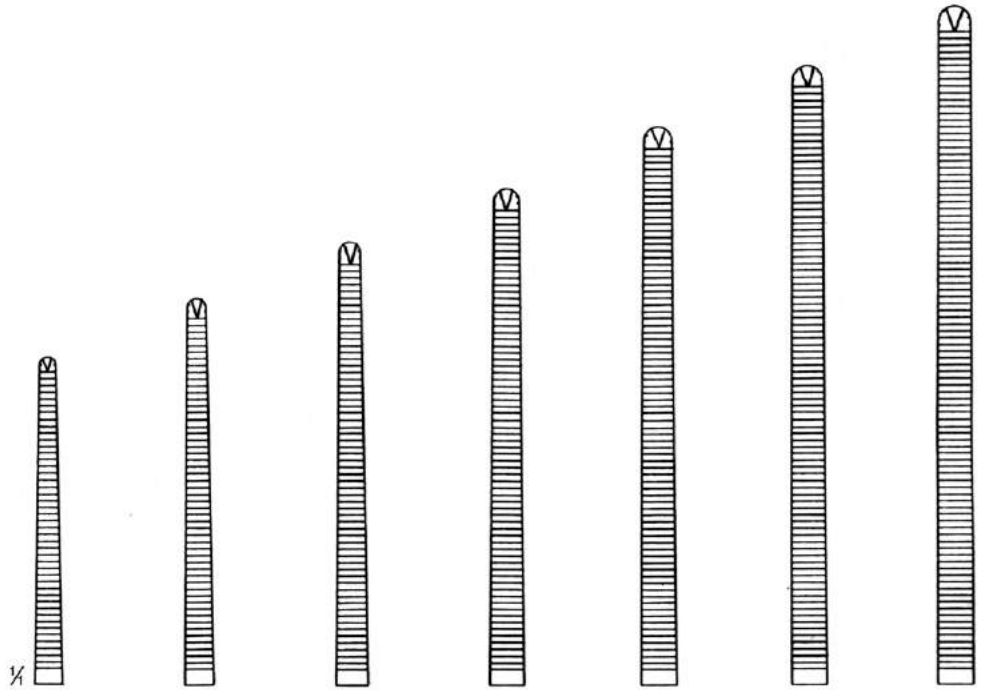

- | | | | | | | |
|--------------|-----------|------------|--------------|--------------|---------------|-----------|
| 16 cm/6 1/4" | 18 cm/7" | 20 cm/8" | 22 cm/8 3/4" | 24 cm/9 1/2" | 26 cm/10 1/4" | 28 cm/11" |
| D-1030.16 | D-1030.18 | D-1030.20) | D-1030.22 | D-1030.24 | D-1030.26 | D-1030.28 |

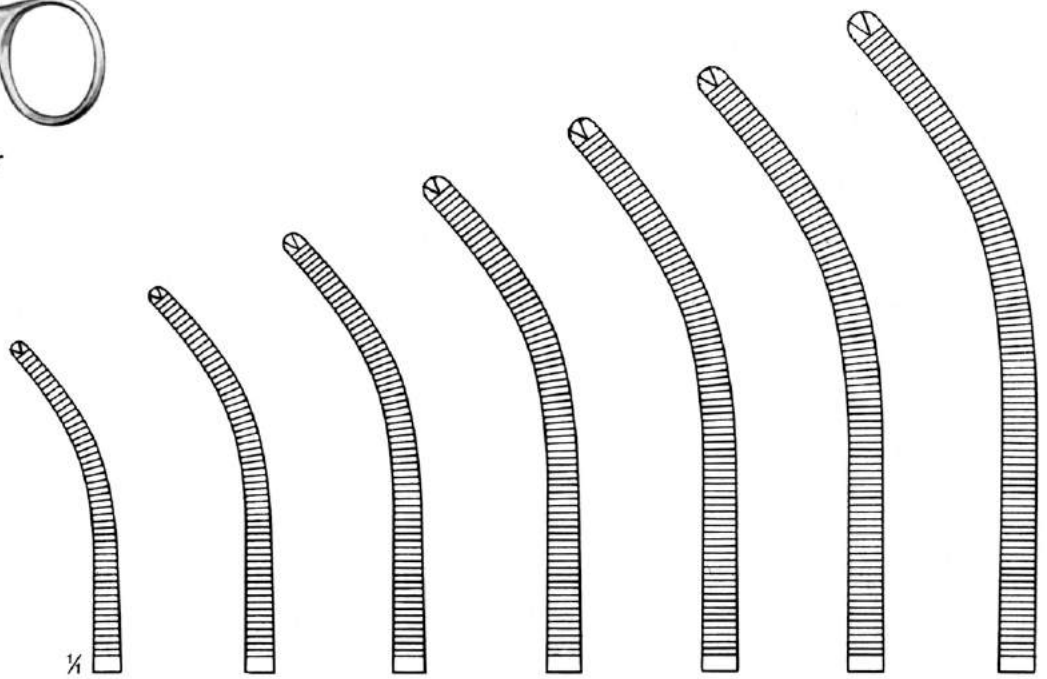

- | | | | | | | |
|--------------|-----------|-----------|--------------|--------------|---------------|-----------|
| 16 cm/6 1/4" | 18 cm/7" | 20 cm/8" | 22 cm/8 3/4" | 24 cm/9 1/2" | 26 cm/10 1/4" | 28 cm/11" |
| D-1031.16 | D-1031.18 | D-1031.20 | D-1031.22 | D-1031.24 | D-1031.26 | D-1031.28 |

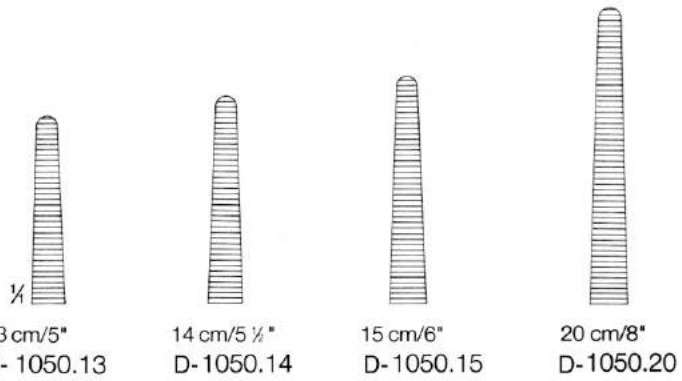

Spencer-Wells (Jones)

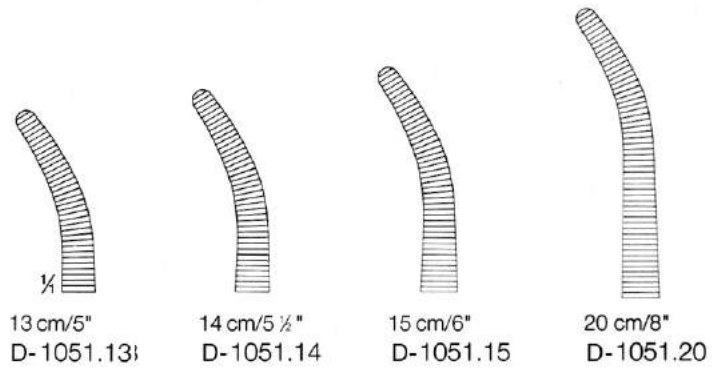



Zenker
 30 cm/12"



D-1059.01

D-1059.02

Thoracic Artery Forceps



Sarot
 24 cm/9 1/2"

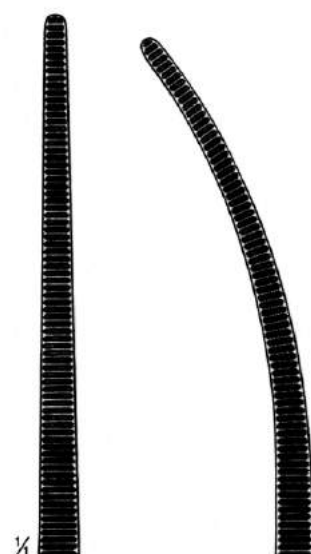

D-1066.24

D-1067.24

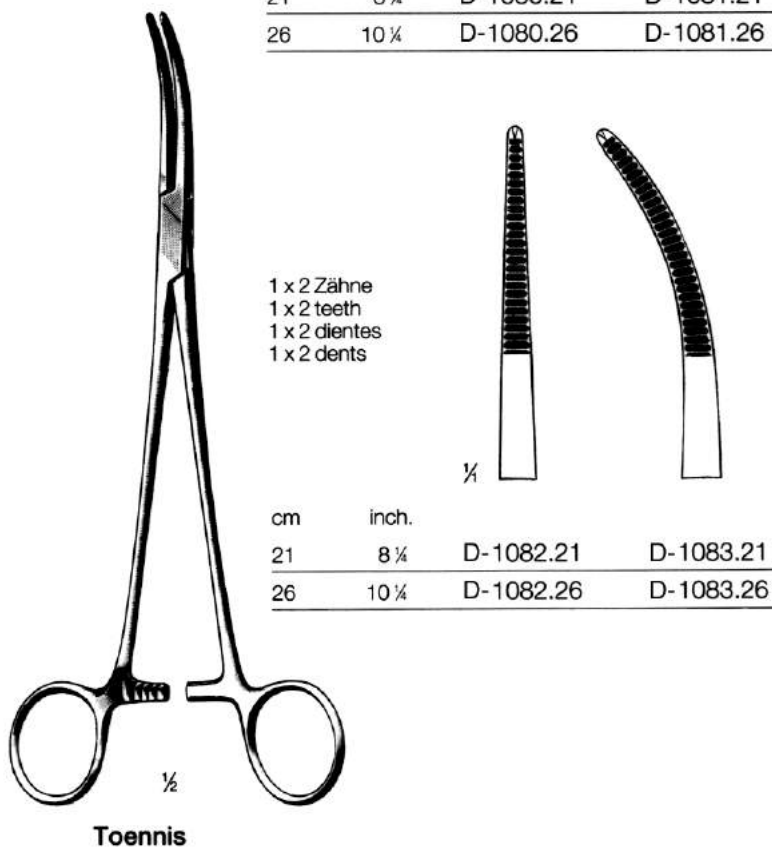
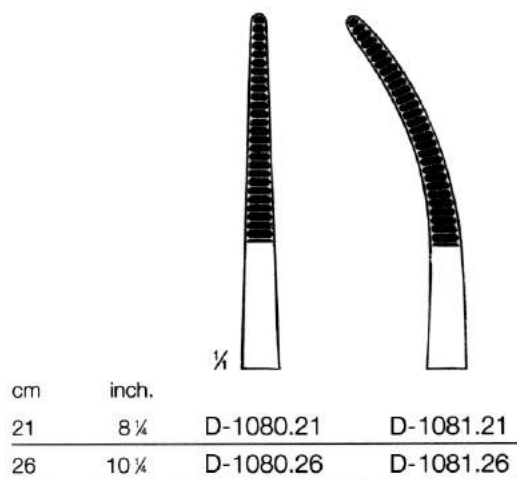
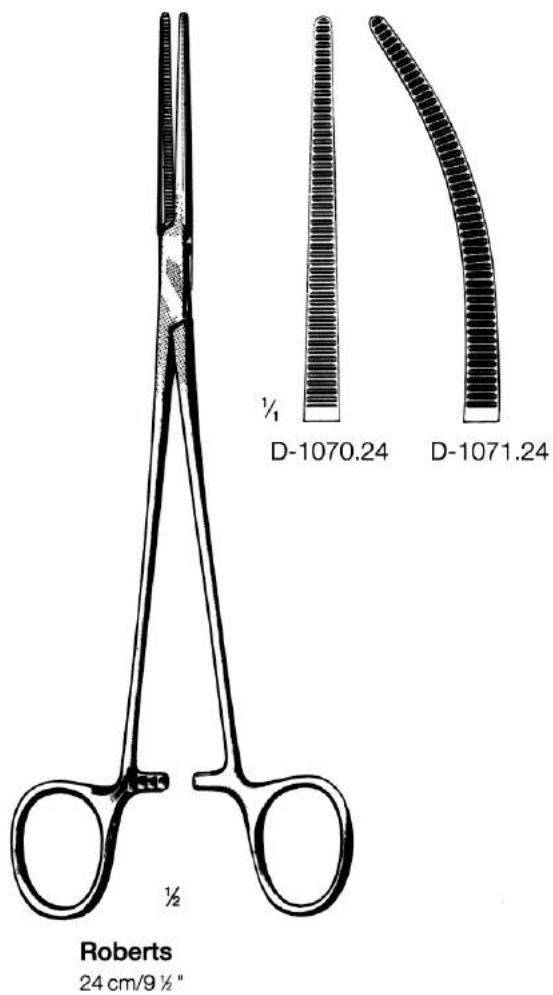

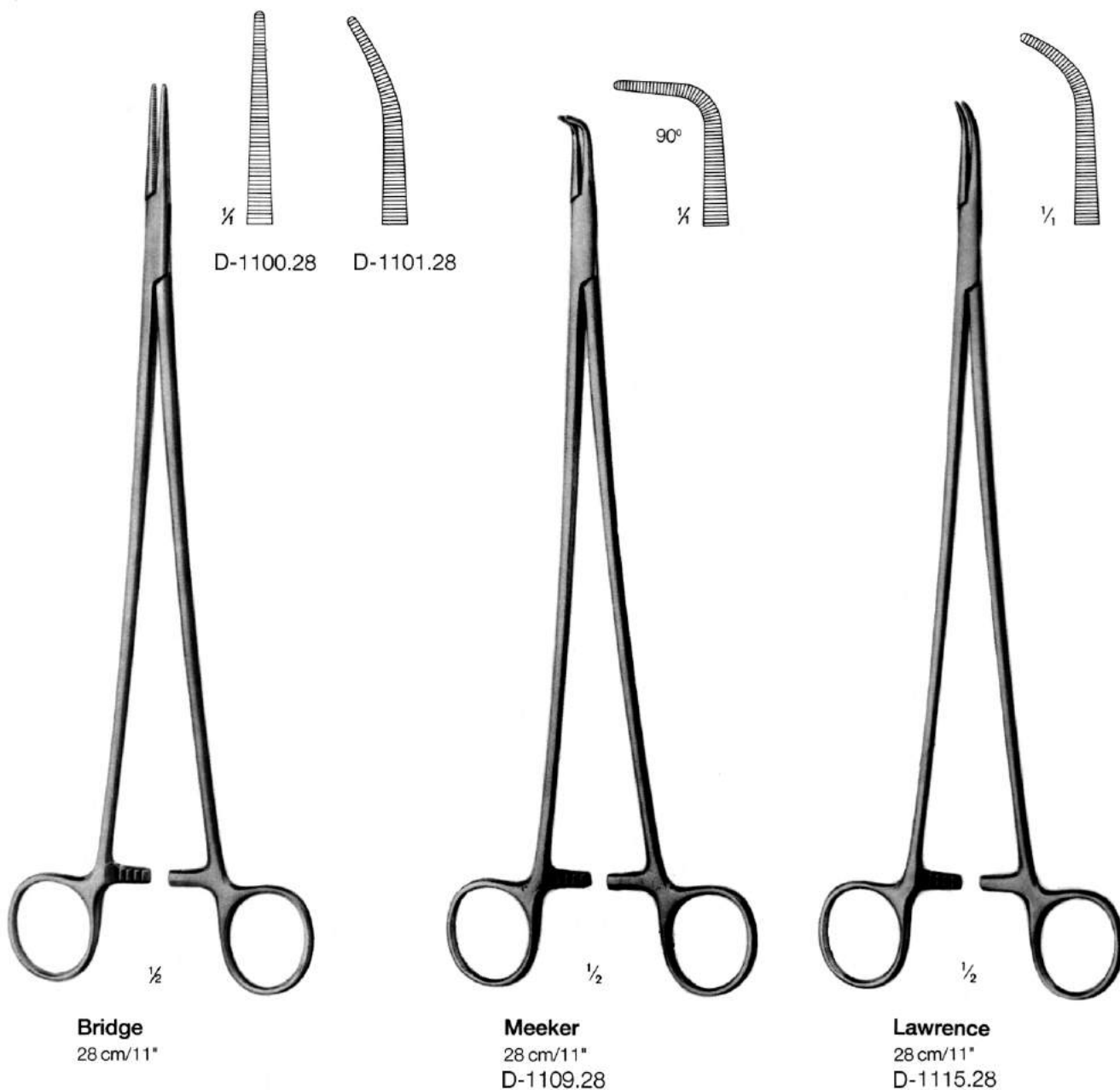

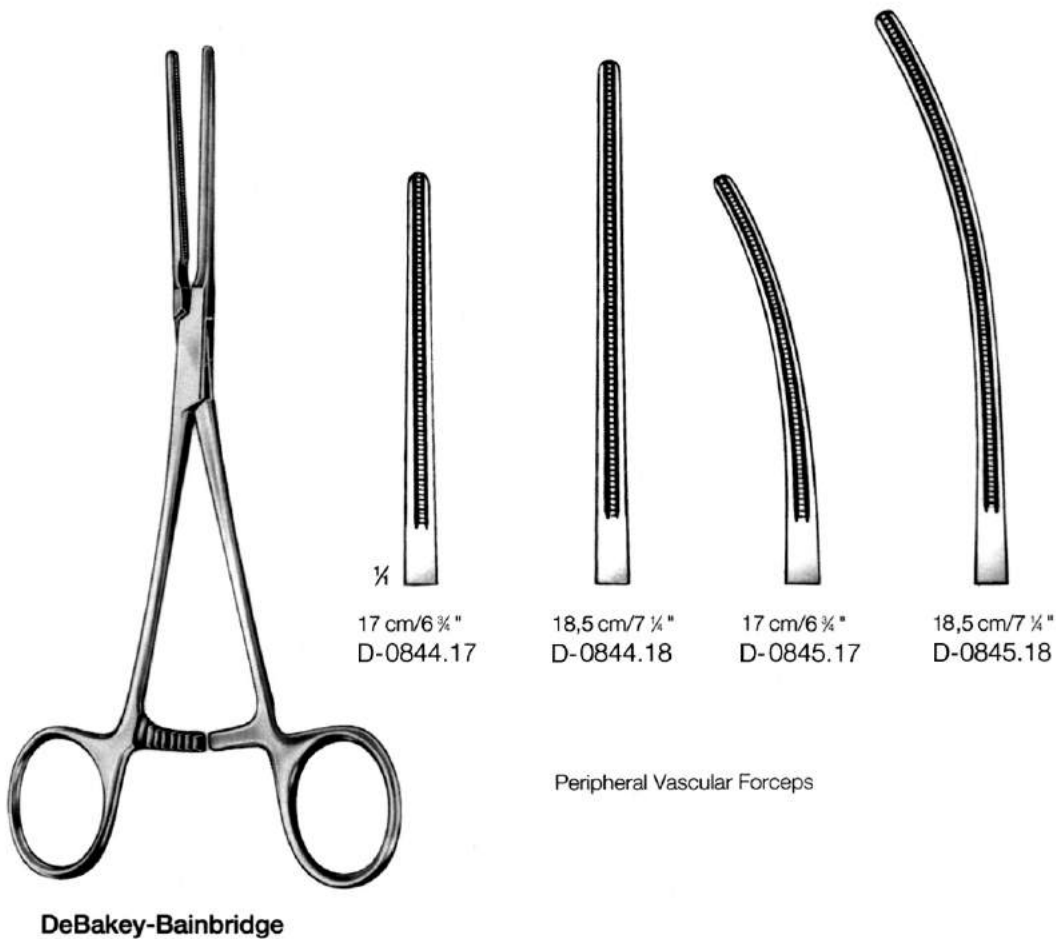
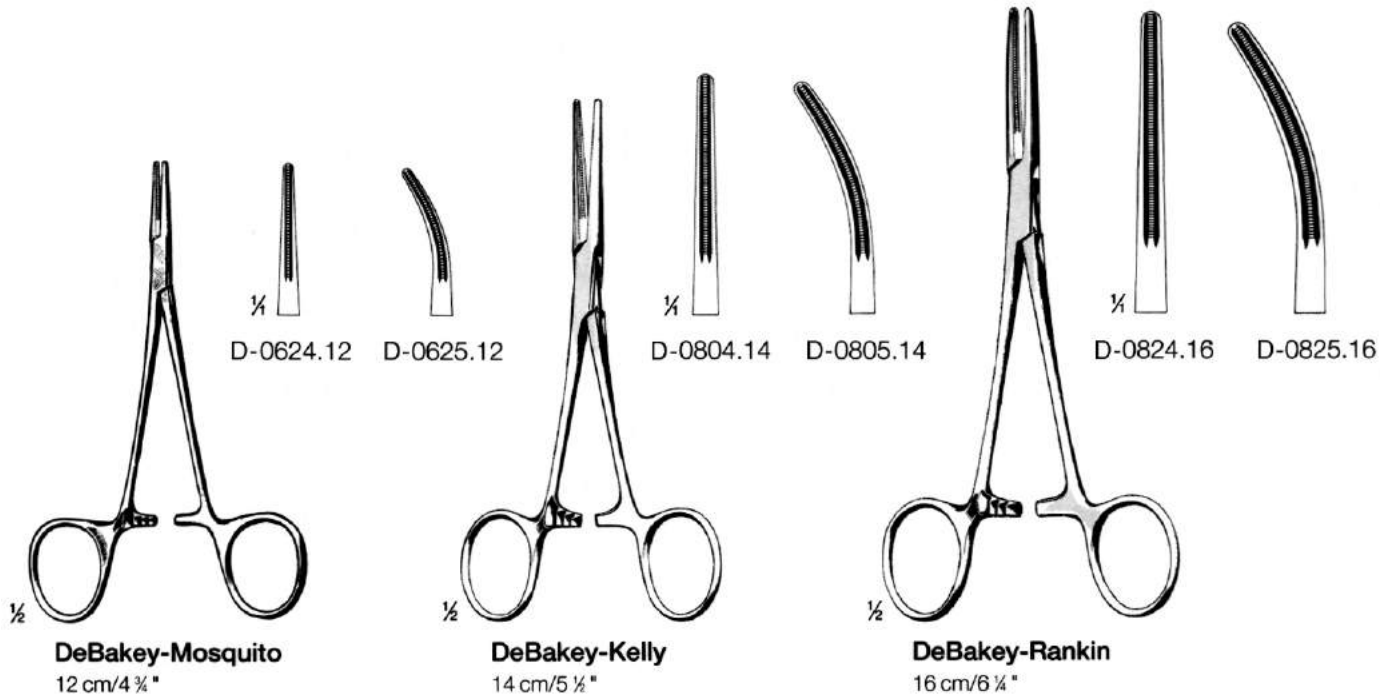

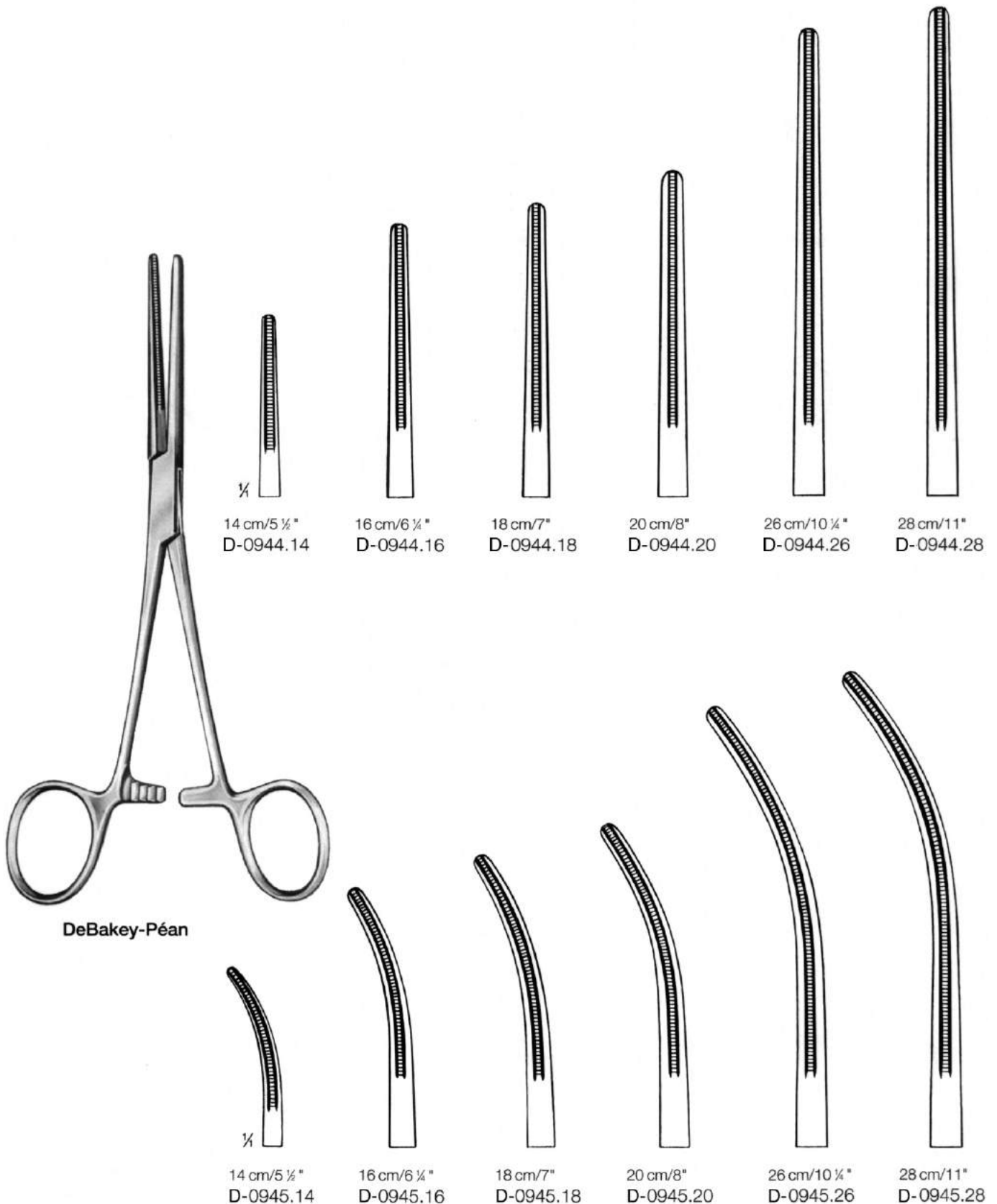

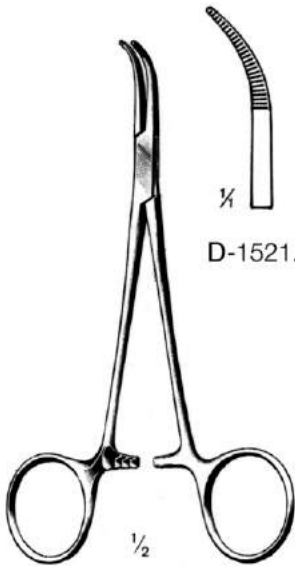

D-1521.01

Baby-Mixer
14 cm/5 1/2"



D-1521.02



Baby-Mixer
14 cm/5 1/2"
D-1521.14

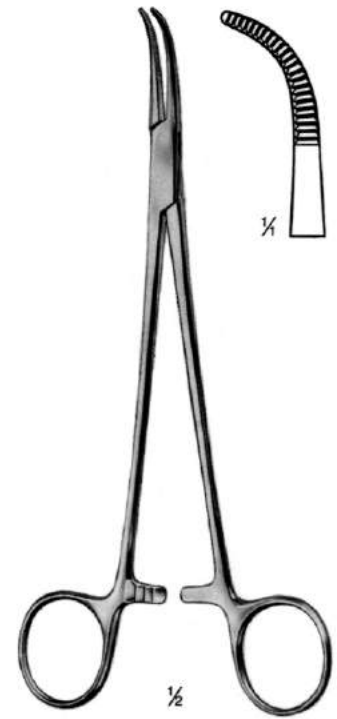

Baby-Mixer
18 cm/7"
D-1521.18

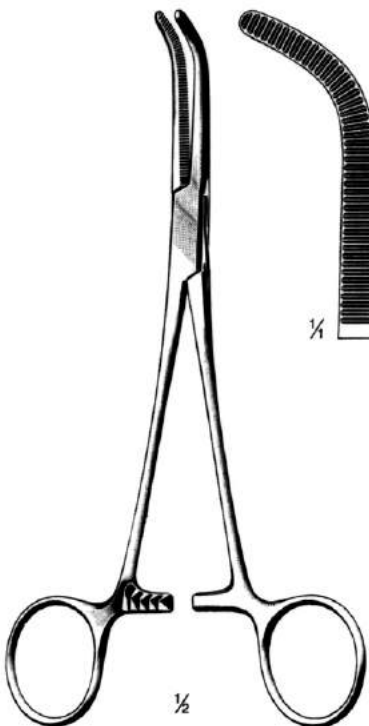

Mixer-O'Shaugnessy
19 cm/7 1/2"
D-1523.19

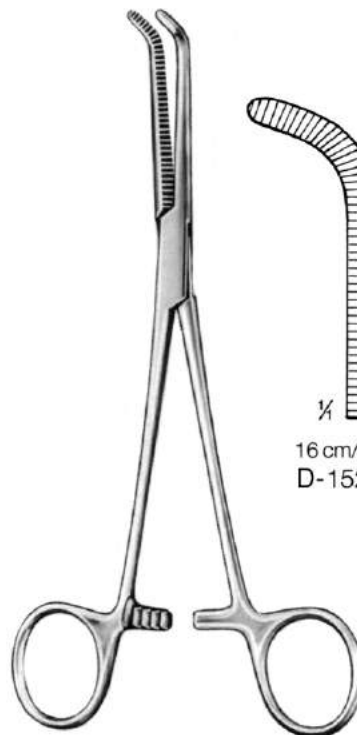

16 cm/6 1/4"
D-1525.16

Mixer

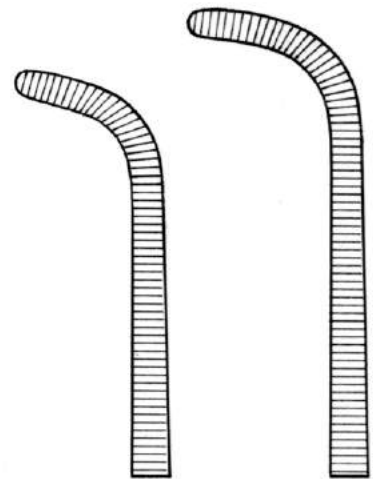

19,5 cm/7 3/4"
D-1525.19

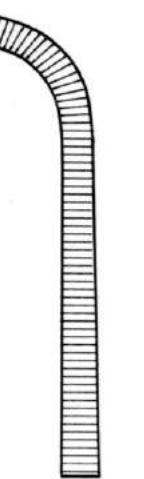

21,5 cm/8 1/2"
D-1525.21

Also Gall Duct Clamps



Baby-Overholt
 13,5 cm/5 1/4"
 D-1537.13



Overholt-Mixter
 21 cm/8 1/4"
 D-1537.21

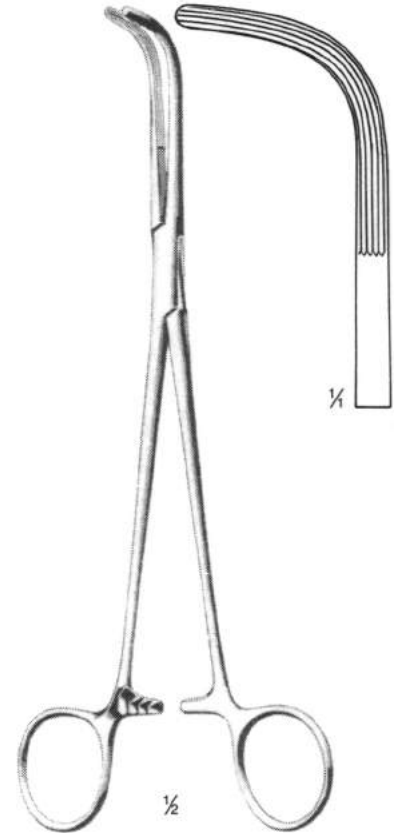

McQuigg-Mixter
 22 cm/8 3/4"
 D-1539.22

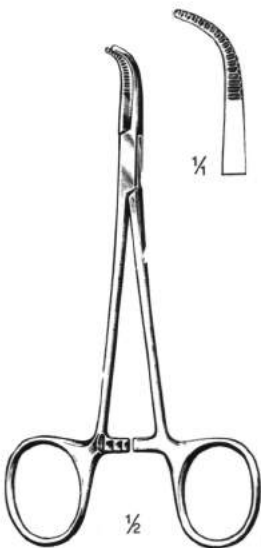

Micro-Adson
 14 cm/5 1/2"
 D-1541.13

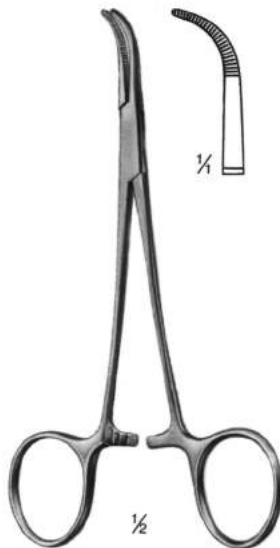

Baby-Adson
 14 cm/5 1/2"
 D-1541.14



Baby-Adson
 18 cm/7"
 D-1541.18

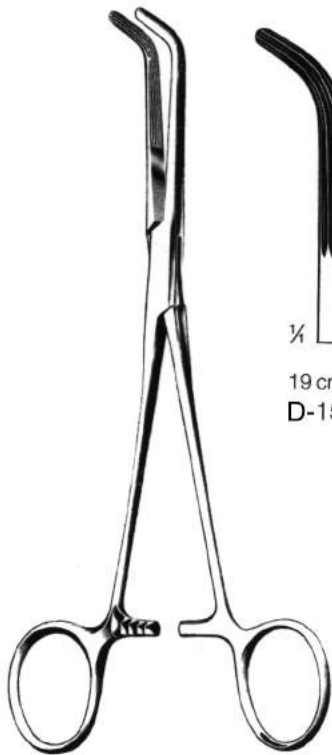

Lahey

¼

19 cm/7 ½"
D-1551.19

23 cm/9"
D-1551.23

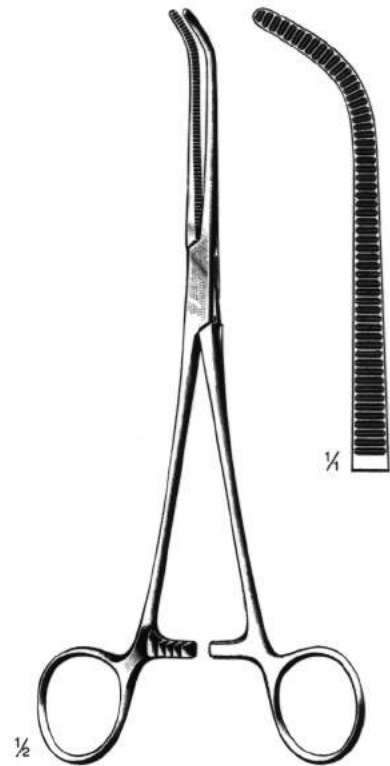

½

Johns-Hopkins
20 cm/8"
D-1559.20

¼



Mixer

¼

22 cm/8 ¾"
D-1563.22



25 cm/10"
D-1563.25



28 cm/11"
D-1563.28



Mixer
23 cm/9"
D-1573.23

¼

½

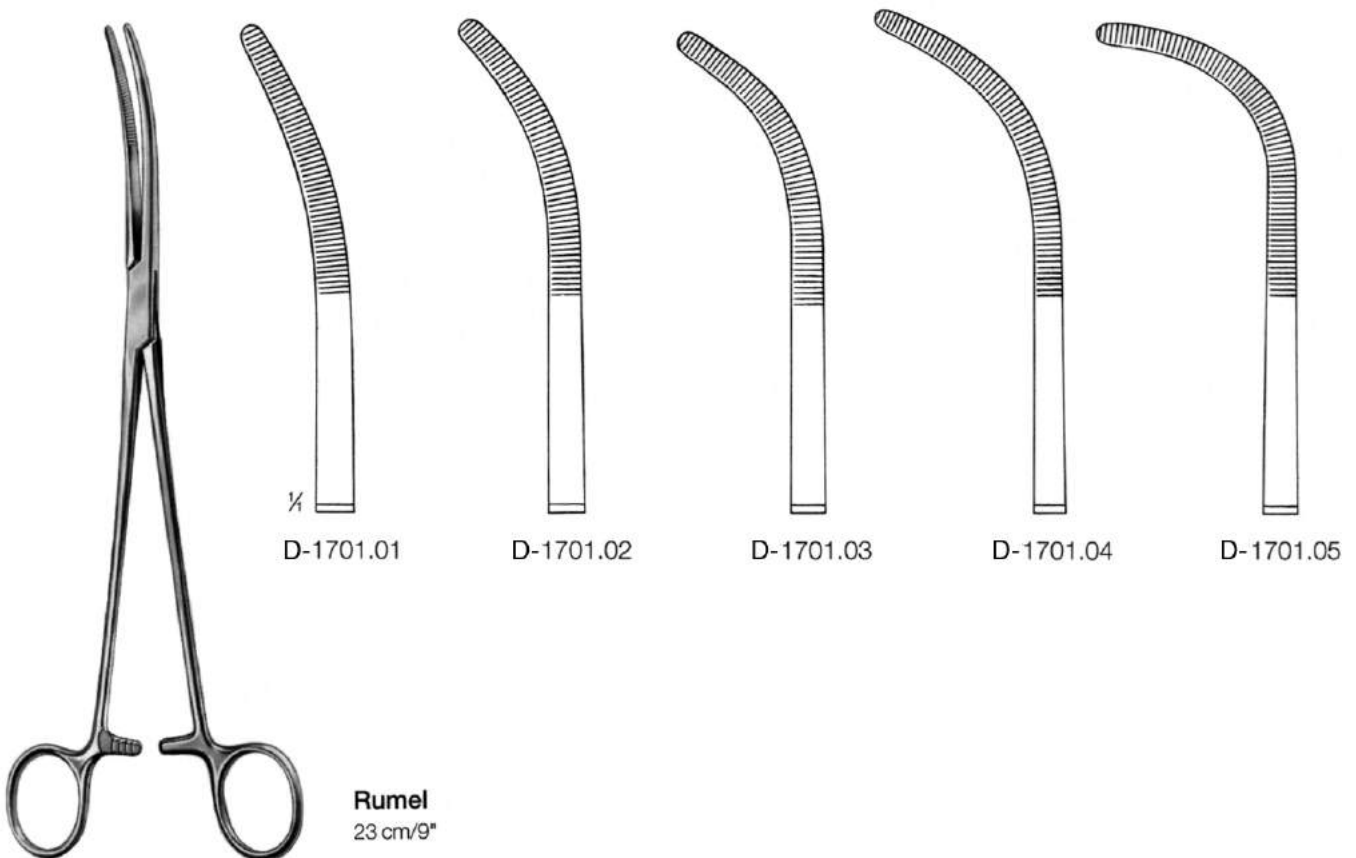
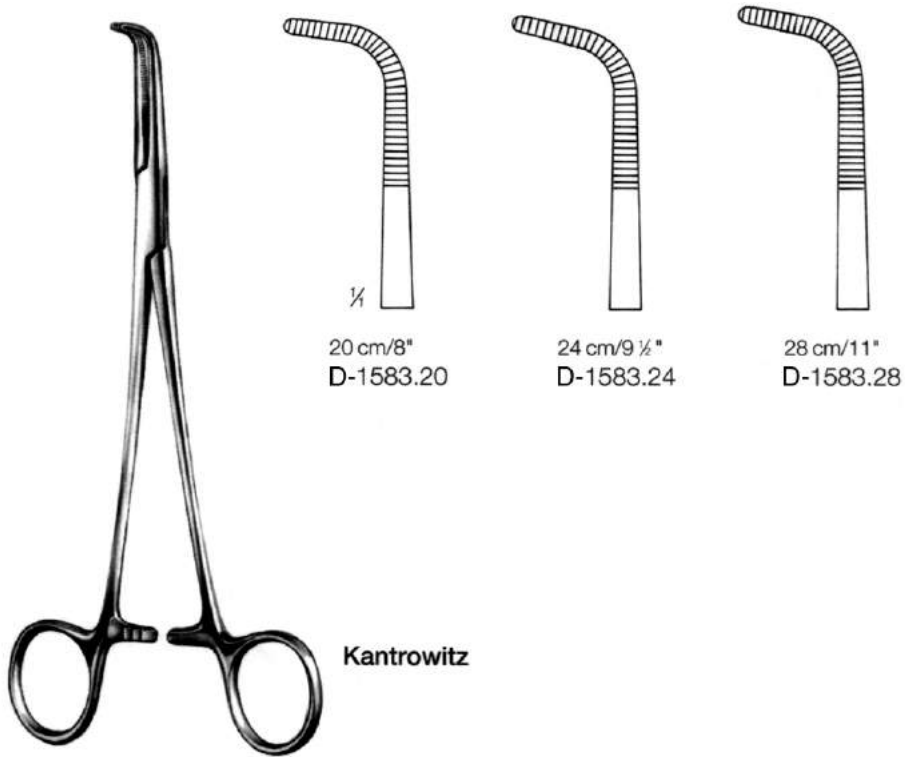

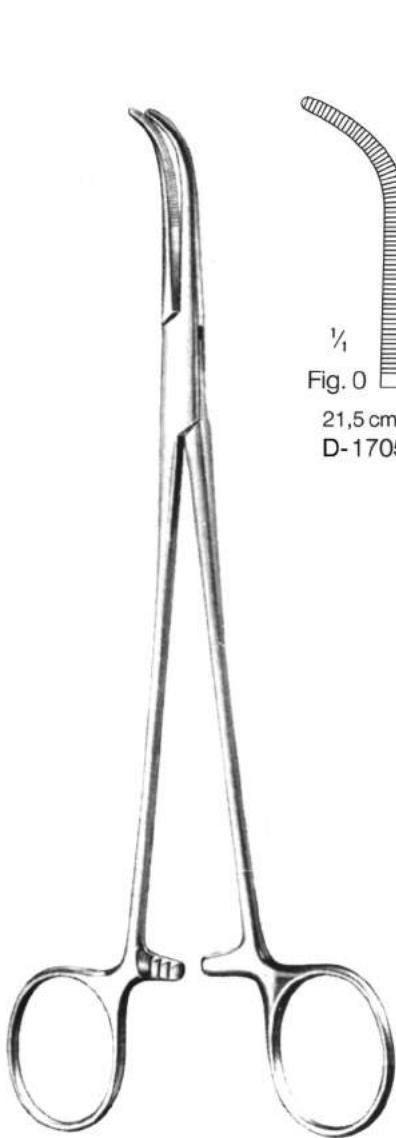

Overholt

delicate pattern

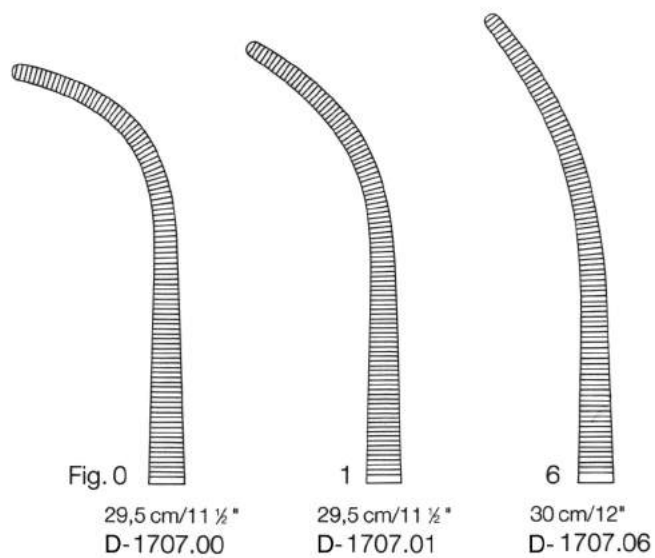
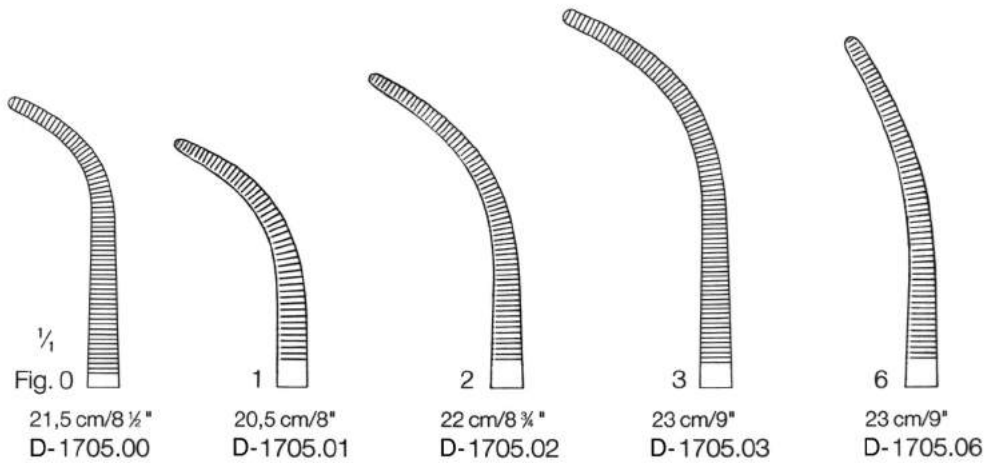



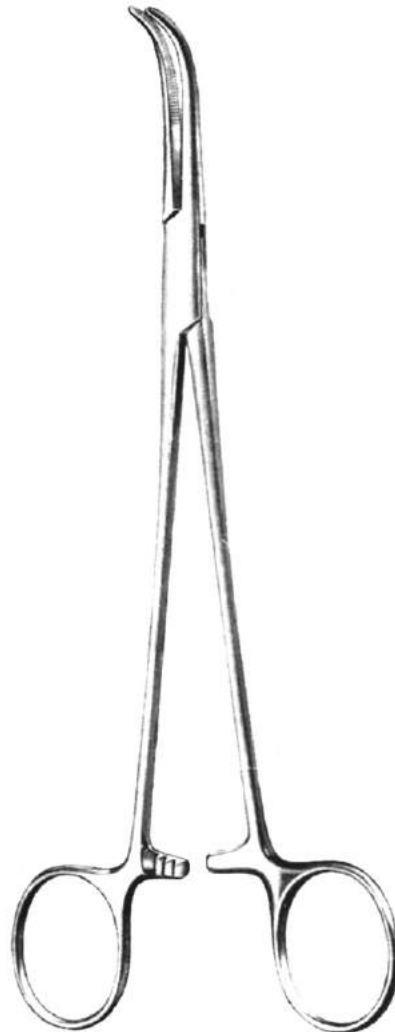

Overholt-Geissendoerfer
 D-1711.##

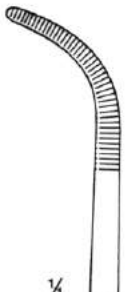
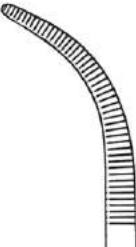
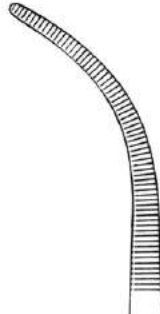
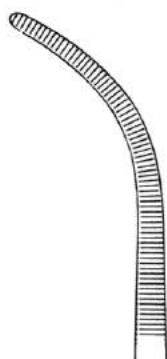
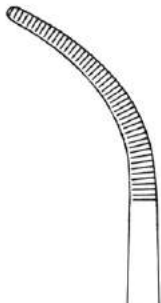
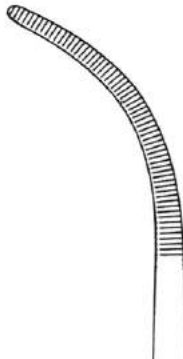

Overholt-Geissendoerfer
 D-1713.##

						
Fig. 0	1	2	3	4	5	6
19,5 cm/7 1/4"	21 cm/8 1/4"	22 cm/8 3/4"	22,5 cm/9"	21,5 cm/8 1/2"	22,5 cm/9"	22,5 cm/9"
D-1711.00	D-1711.01	D-1711.02	D-1711.03	D-1711.04	D-1711.05	D-1711.06
26 cm/10 1/2"	27 cm/10 1/2"	27,5 cm/10 3/4"	27,5 cm/10 3/4"	27,5 cm/10 3/4"	28 cm/11"	27,5 cm/10 3/4"
D-1713.00	D-1713.01	D-1713.02	D-1713.03	D-1713.04	D-1713.05	D-1713.06

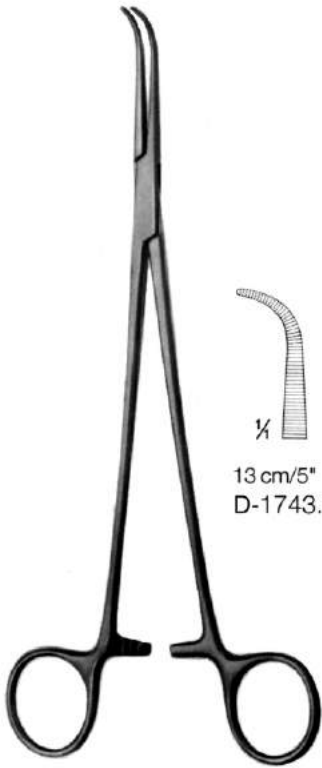

Gemini (DeBakey-Mixter)

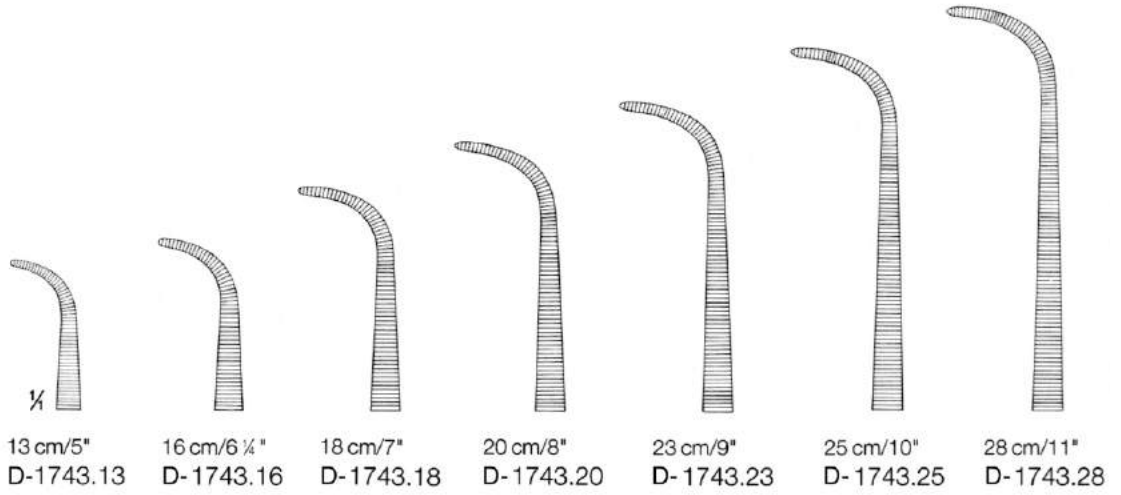

Gemini-Mini (Mixter)

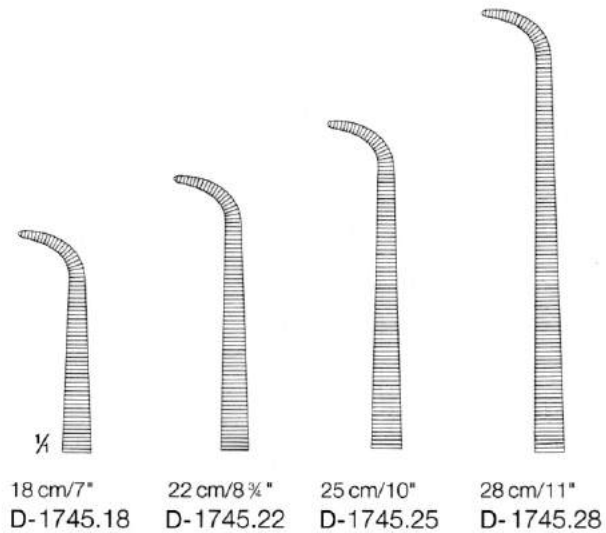

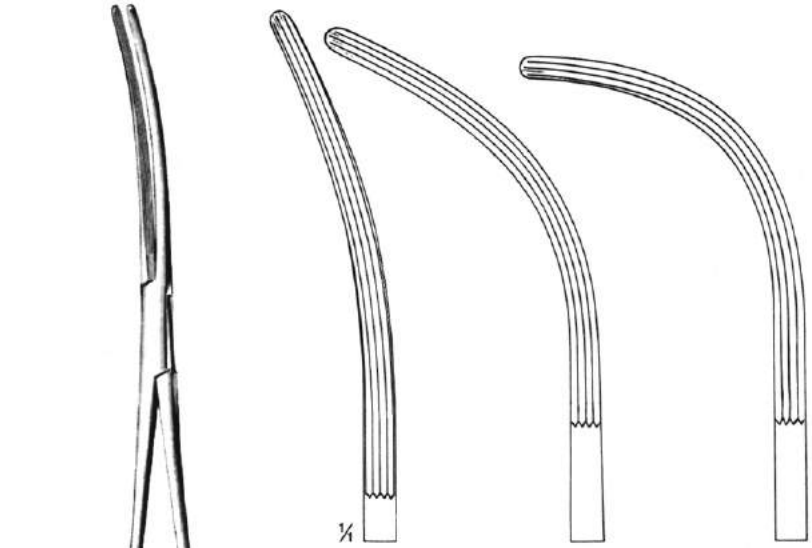

Fig. 1
D-1785.24

Fig. 2
D-1785.23

Fig. 3
D-1785.22



Crafoord-Sellors
24 cm/9 1/2"

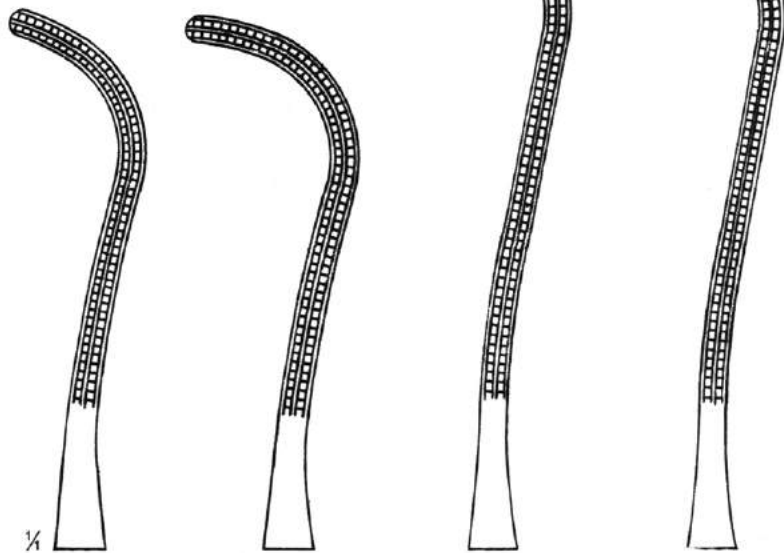

Fig. 1
D-1703.01

Fig. 2
D-1703.02

Fig. 3
D-1703.03

Fig. 4
D-1703.04

DeBakey-Rumel
23 cm/9"

Thoracic Forceps

Vena cava Clamps

Thorax and Auricle Forceps

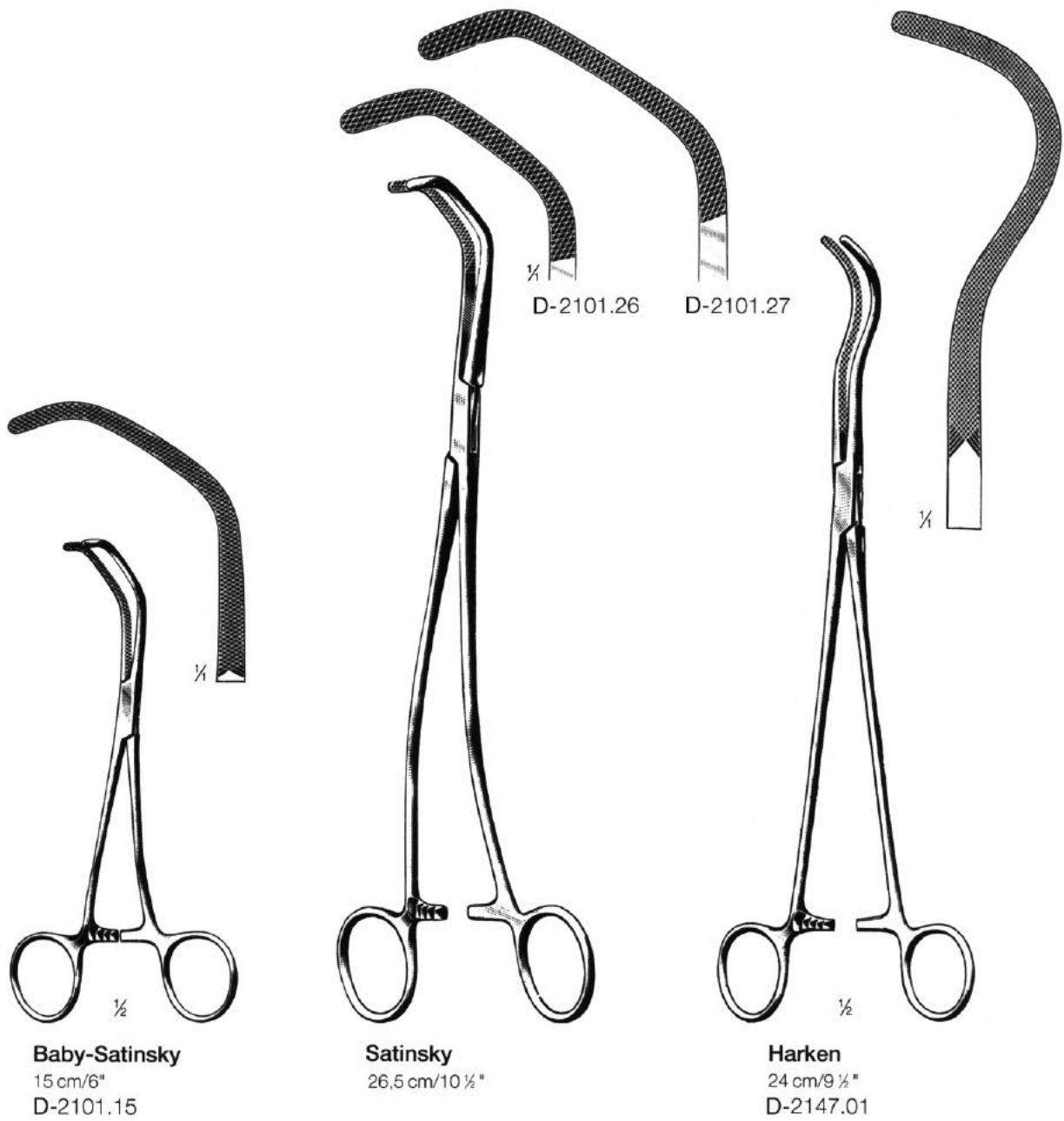

Anastomosis Forceps



DeBakey-Glover



21 cm/8 ¼"
D-2301.21



24 cm/9 ½"
D-2301.24



21 cm/8 ¼"
D-2303.21



26 cm/10 ¼"
D-2303.26

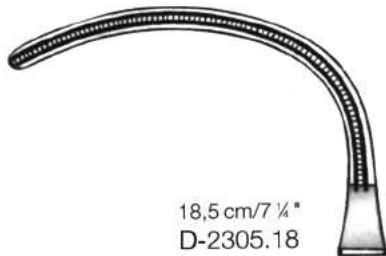

18,5 cm/7 ¼"
D-2305.18

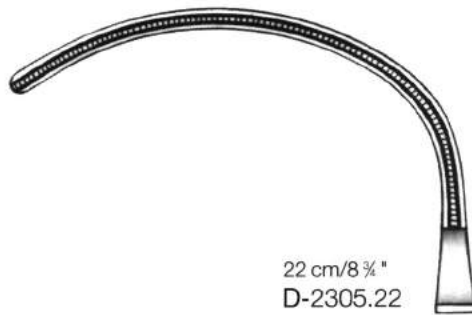

22 cm/8 ¾"
D-2305.22

Aortic Forceps

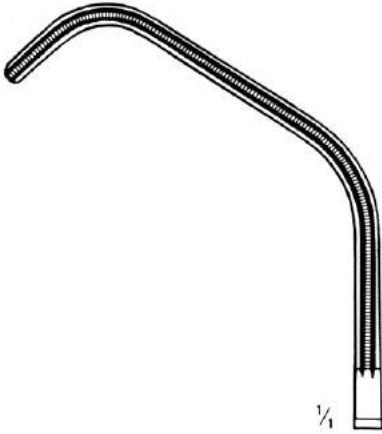

¼

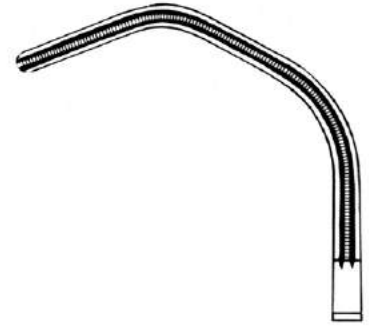
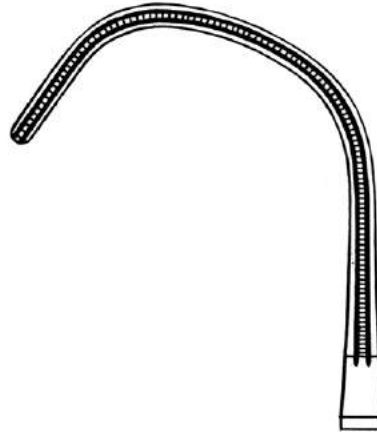

Ochsner
 23,5 cm/9 ¼"
 D-2331.23



Liddle
 27 cm/10 ¼"
 D-2343.27



Diethrich
 21 cm/8 ¼"
 D-2355.21

Aortic Forceps

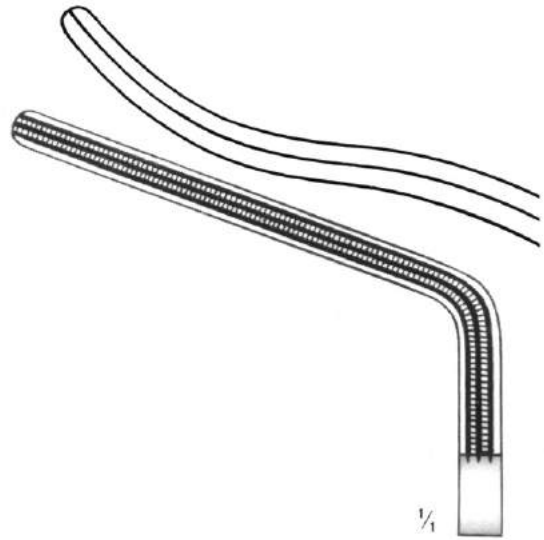
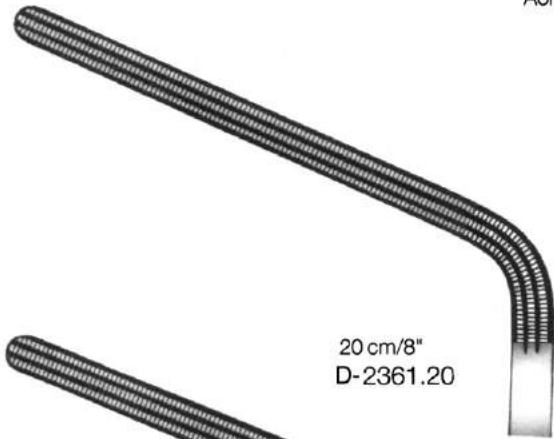

Aortic Forceps, angled, cup shaped jaw

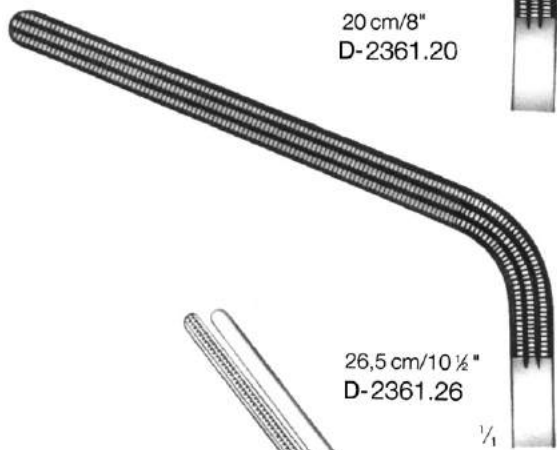

DeBakey-Morris



DeBakey
 27 cm/10 3/4"
 D-2367.27

Aortic Forceps

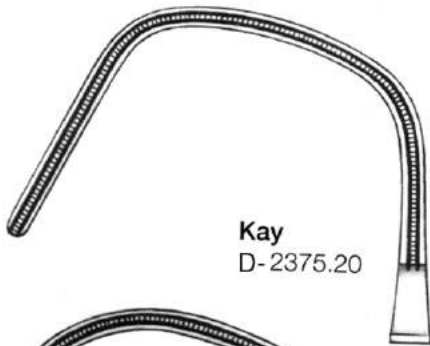

Kay
D-2375.20



Lambert-Kay
D-2375.21



1/4

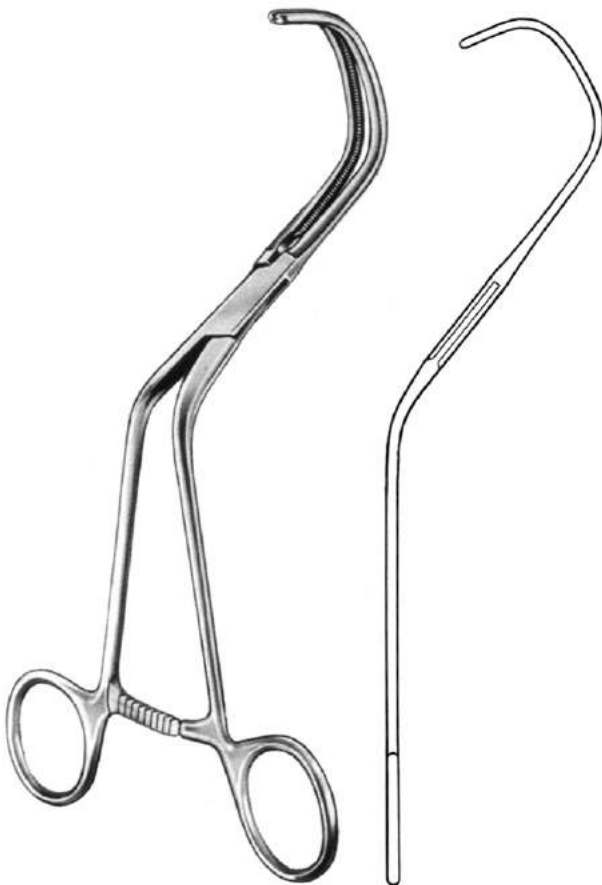

Kay/Lambert-Kay
20 cm/8"

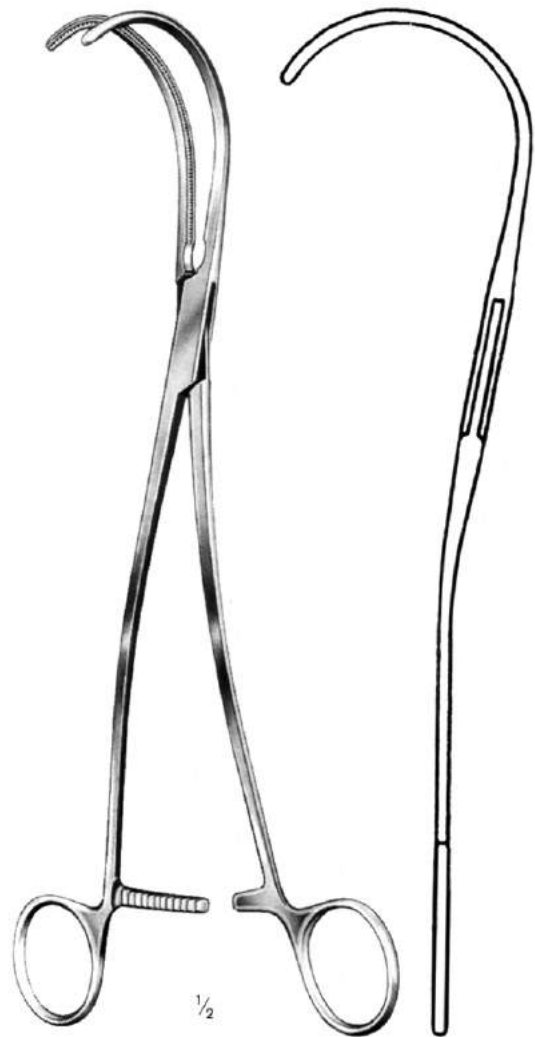

1/2

DeBakey
26,5 cm/10 1/2"
D-2391.26

Aortic Forceps

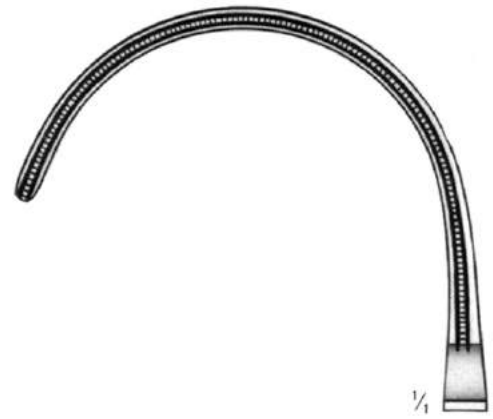

left
D-2393.26



Weber
26 cm/10 $\frac{1}{4}$ "

right
D-2395.26

Aortic Aneurysm Clamps





$\frac{1}{4}$
24,5 cm/9 $\frac{3}{4}$ "
D-2407.24

25,5 cm/10"
D-2407.25

26,5 cm/10 $\frac{1}{2}$ "
D-2407.26

DeBakey-Bahnson

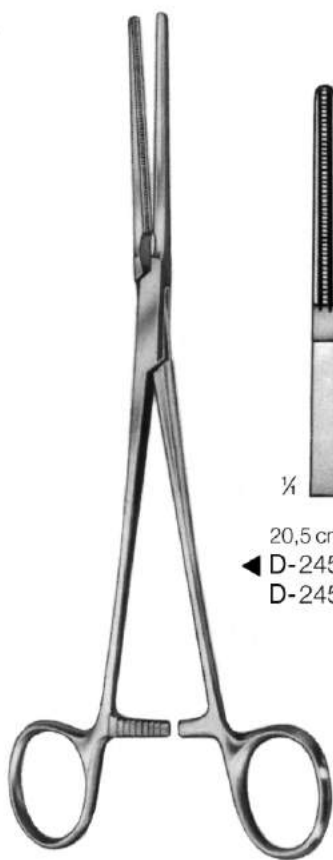

Glover

20,5 cm/8"
 ◀ D-2450.20
 D-2451.20



22 cm/8 3/4"
 D-2450.22
 D-2451.22



26 cm/10 1/4"
 D-2450.26
 D-2451.26 ▶

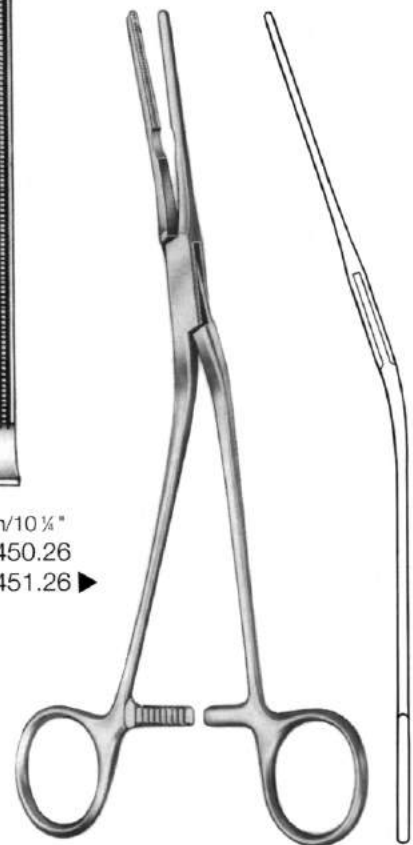

Glover

Peripheral Vascular Forceps

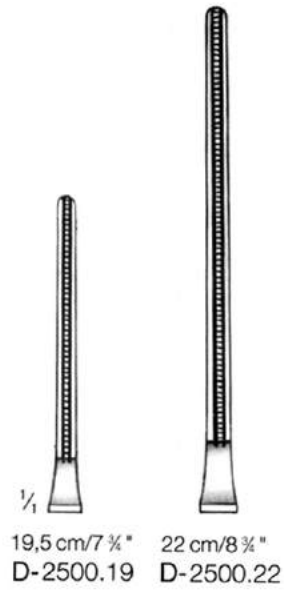
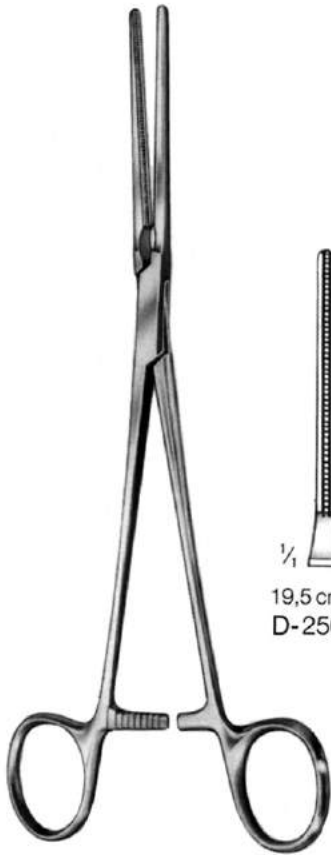

DeBakey

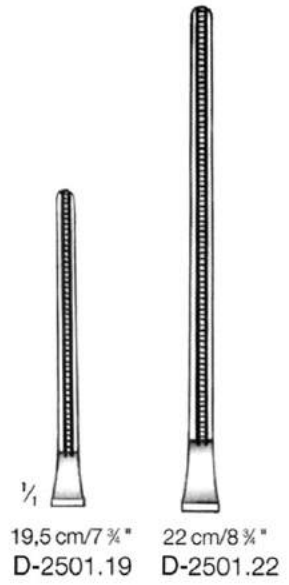

DeBakey



DeBakey

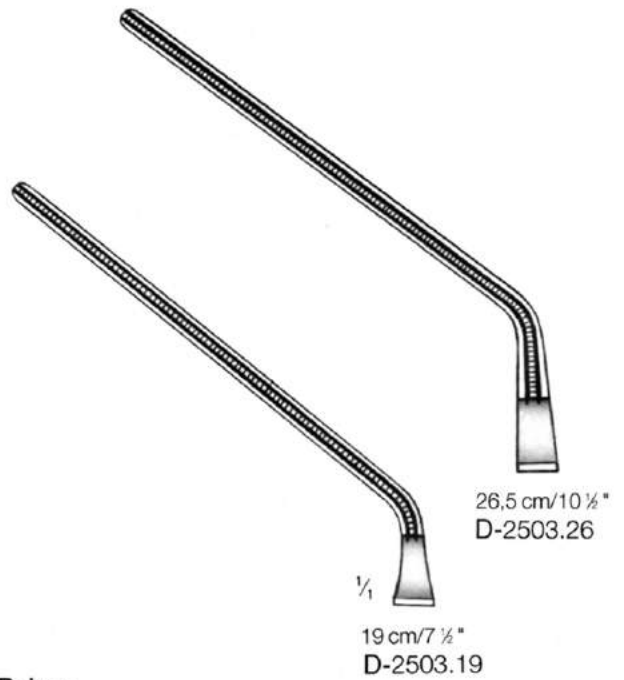

Peripheral Vascular Forceps



Dale

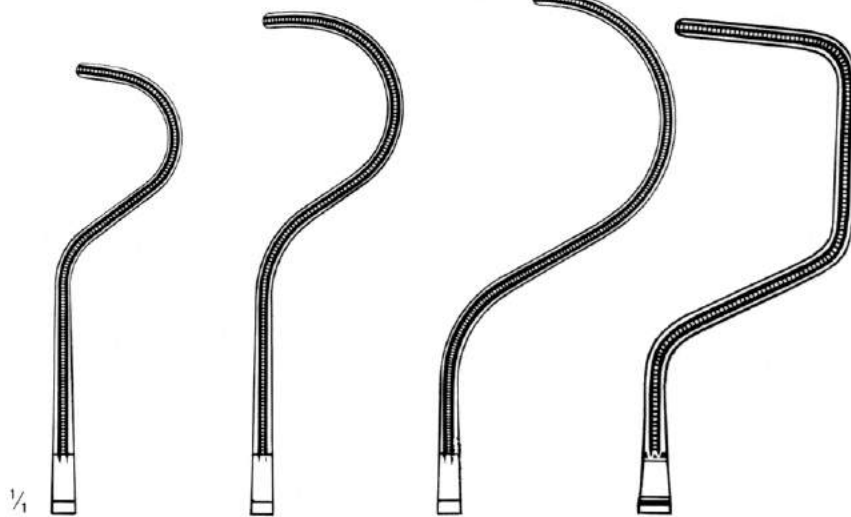

$\frac{1}{4}$
 17 cm/6 $\frac{1}{2}$ "
 D-2507.17

17,5 cm/7"
 D-2507.18

18,5 cm/7 $\frac{1}{4}$ "
 D-2507.19

18,5 cm/7 $\frac{1}{4}$ "
 D-2509.18



DeBakey
 16 cm/6 $\frac{1}{4}$ "
 D-2531.16



$\frac{1}{4}$

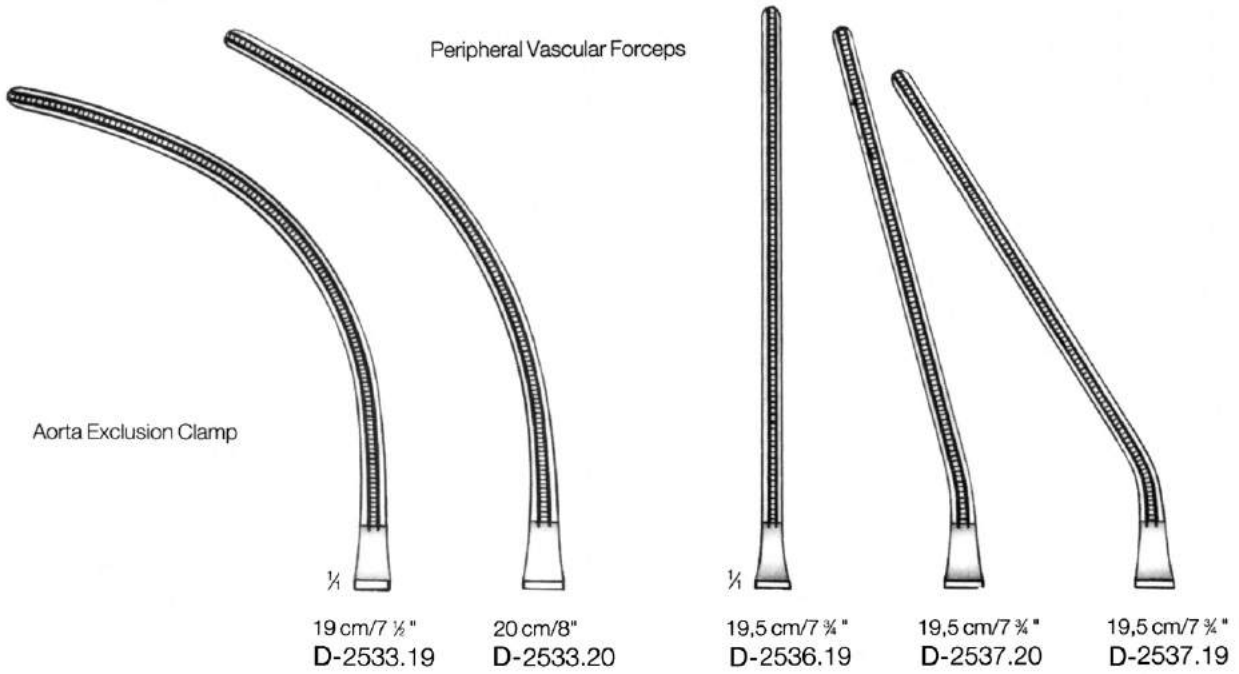

DeBakey



Leland-Jones

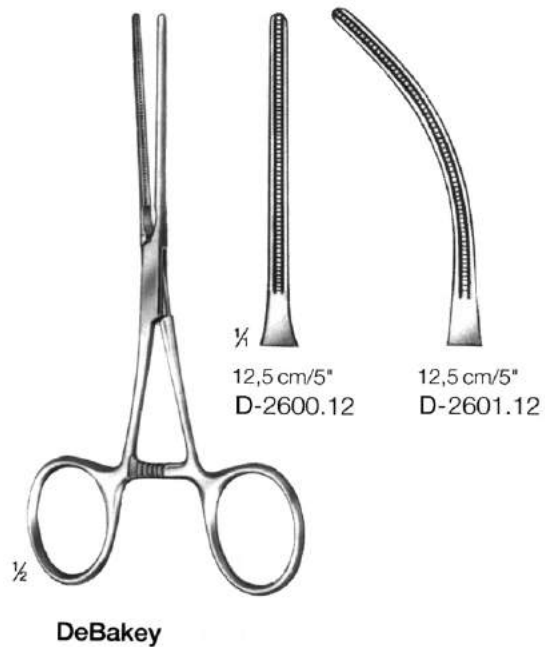

Artery and Bronchus Forceps

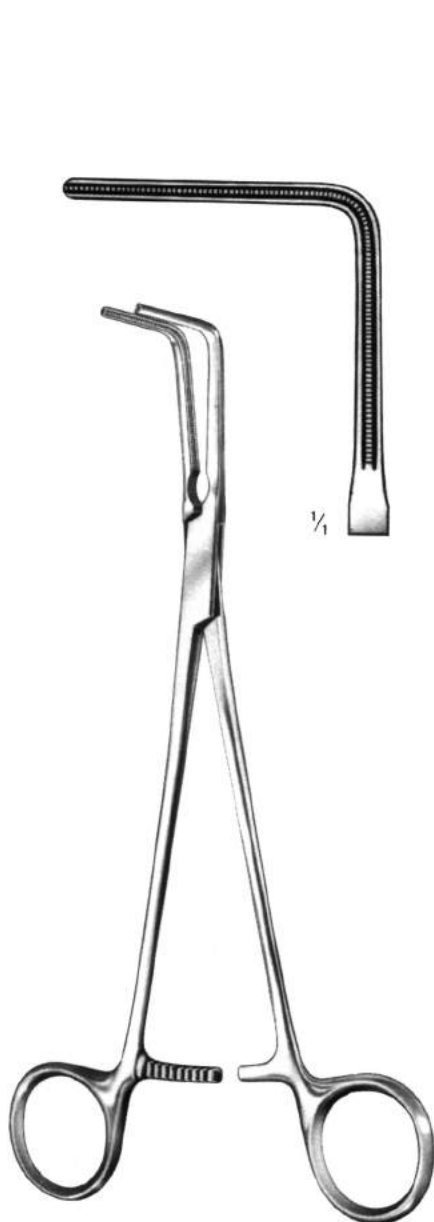

Lees
23 cm/9"
D-2651.23

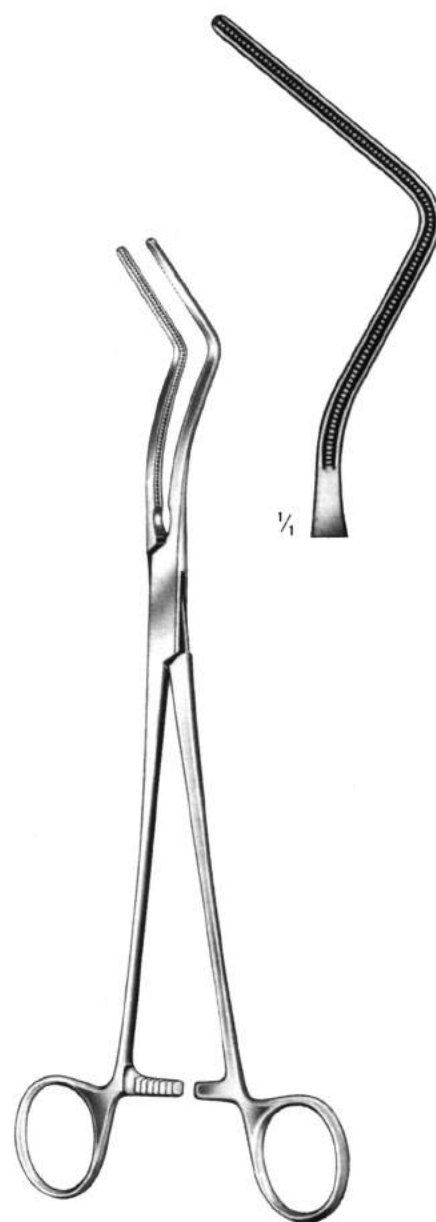

Lees
25 cm/10"
D-2653.25

Multi Purpose Forceps, angled 60°

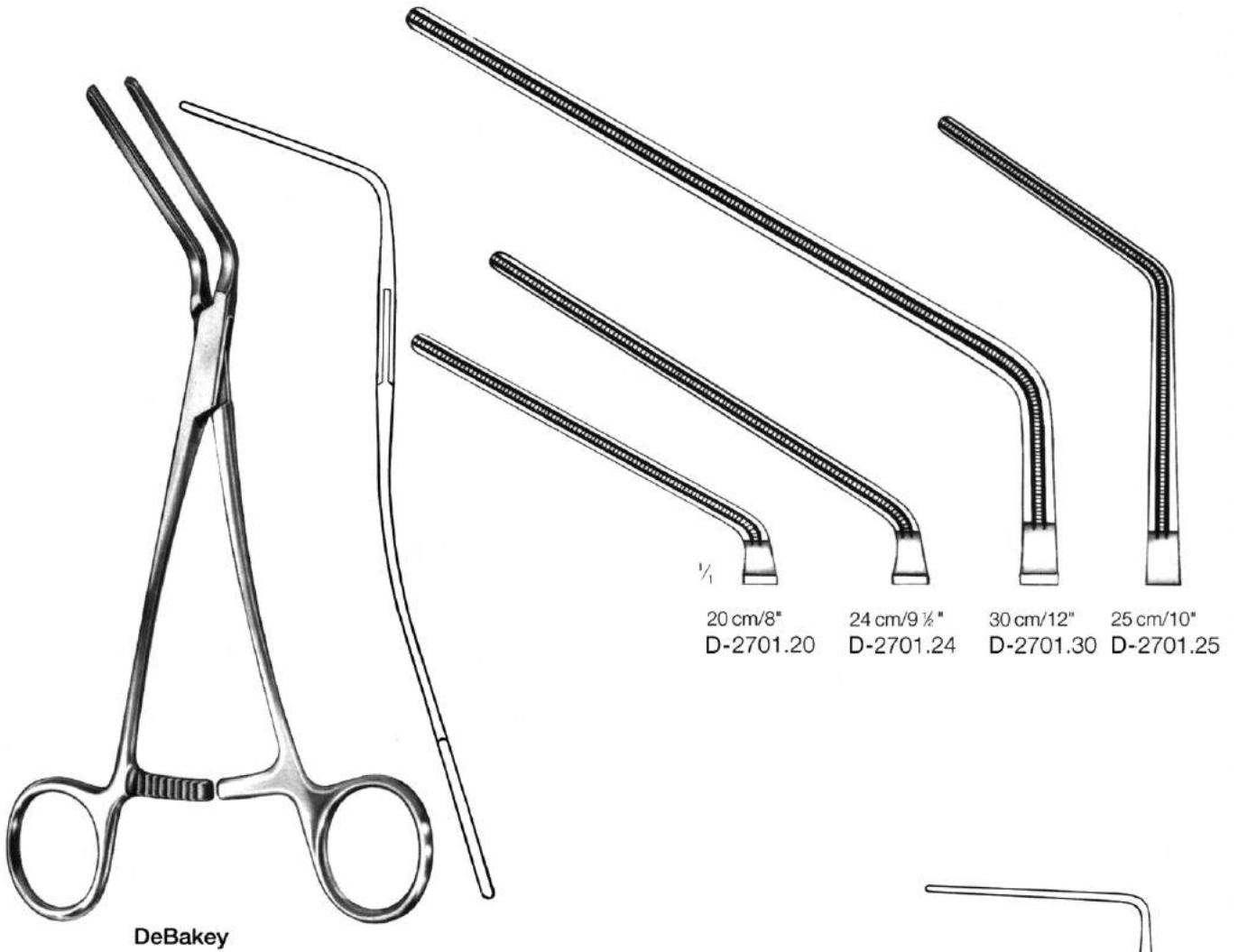

Multi Purpose Forceps, angled 90°

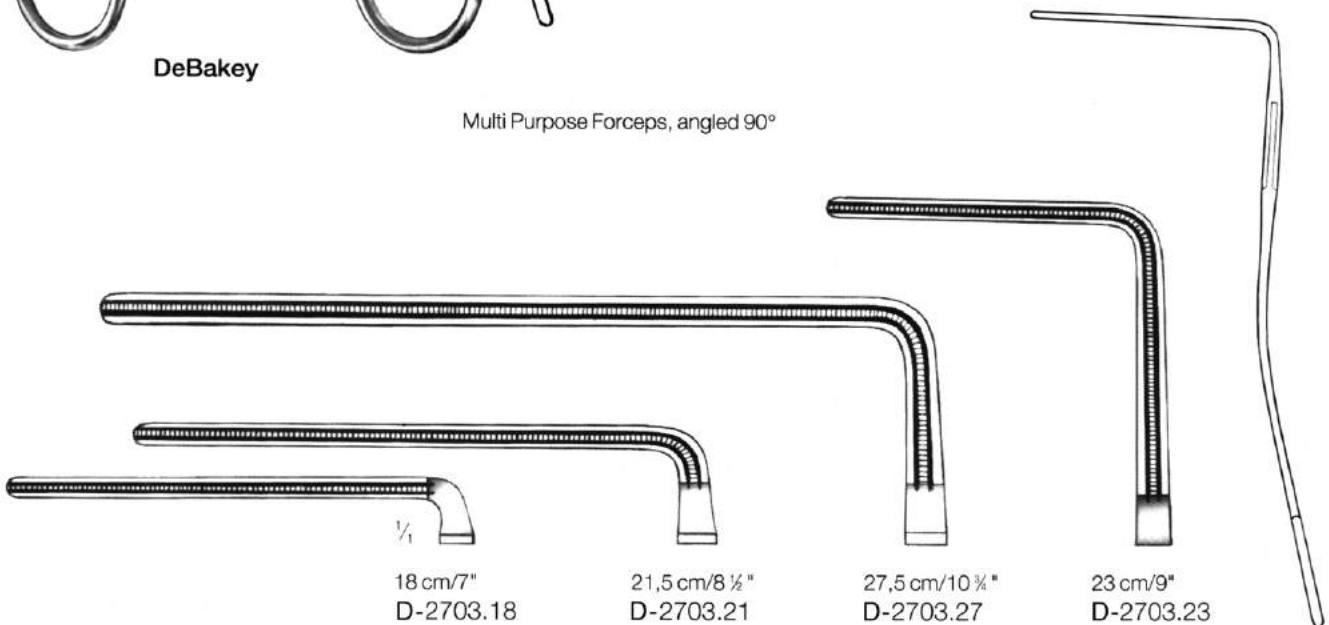

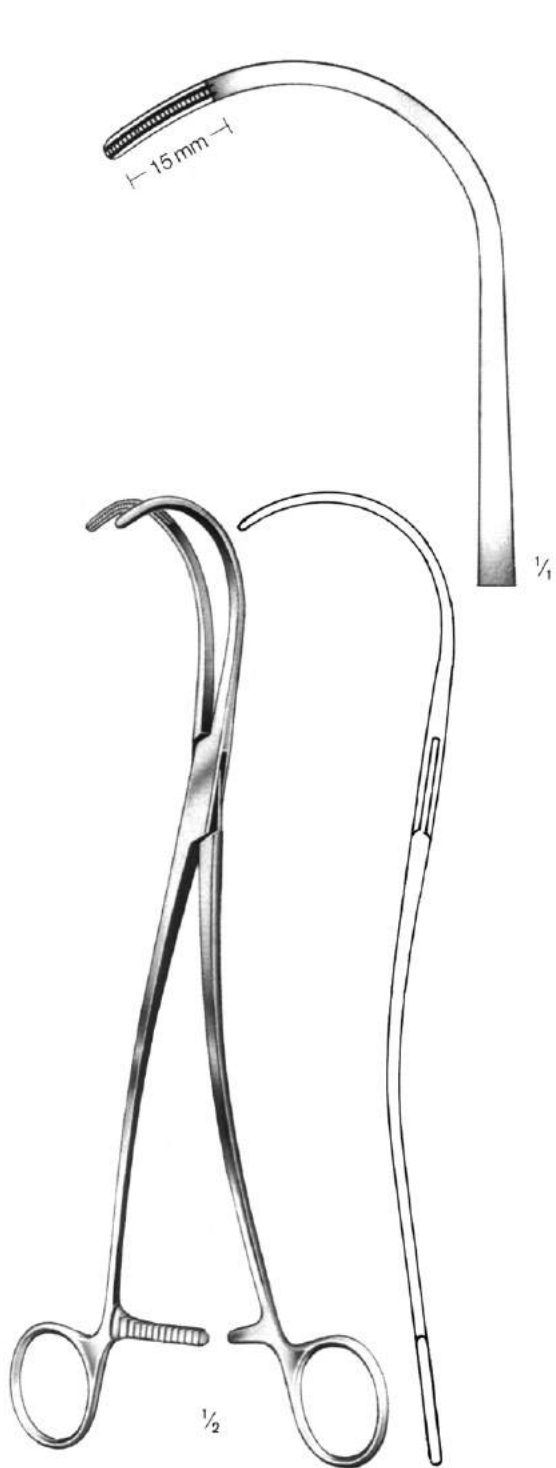

DeBakey-Semb
 25 cm/10"
 D-2727.25

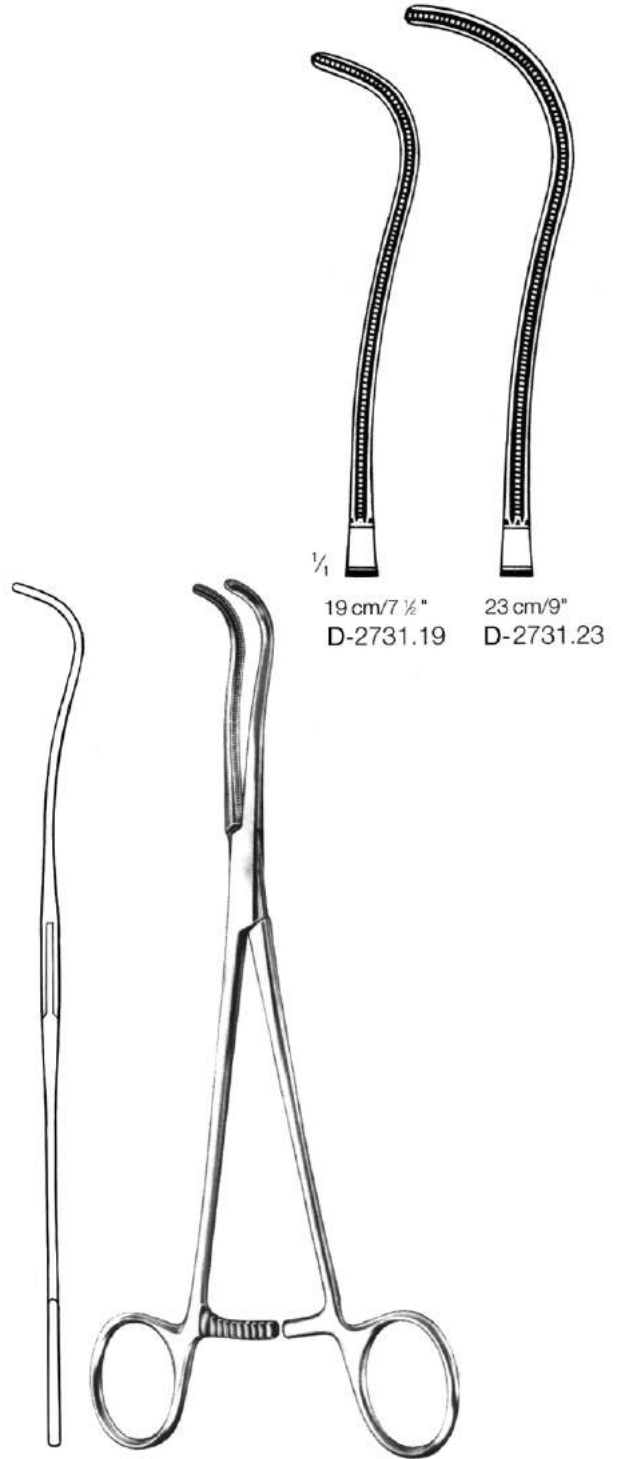

DeBakey

19 cm/7 1/2"
 D-2731.19 23 cm/9"
 D-2731.23

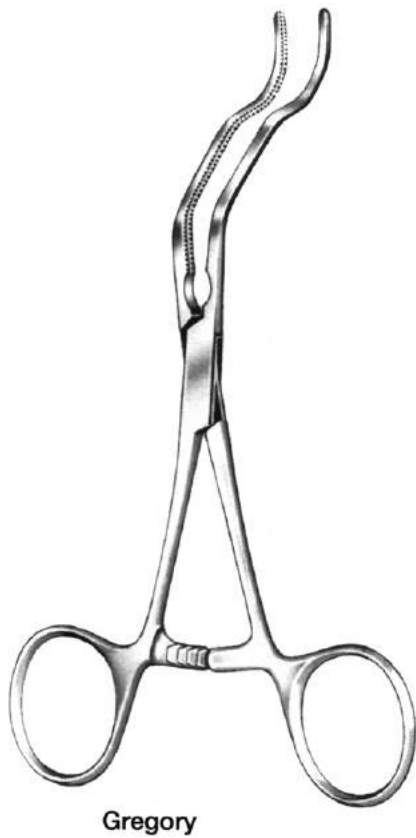
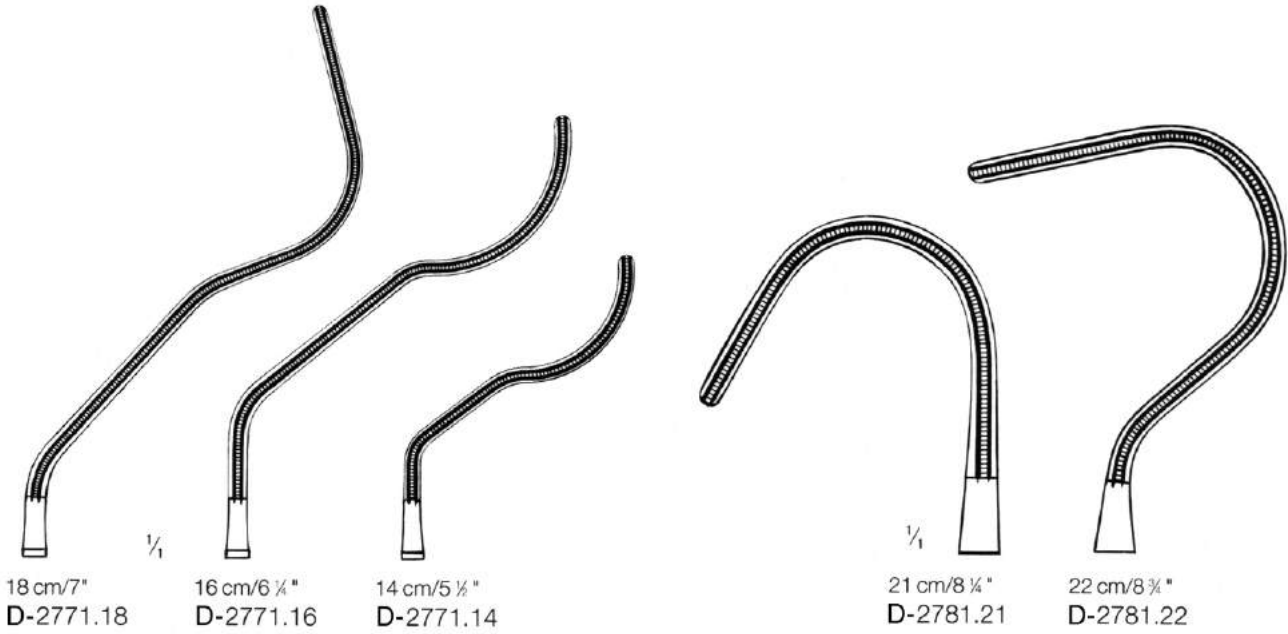

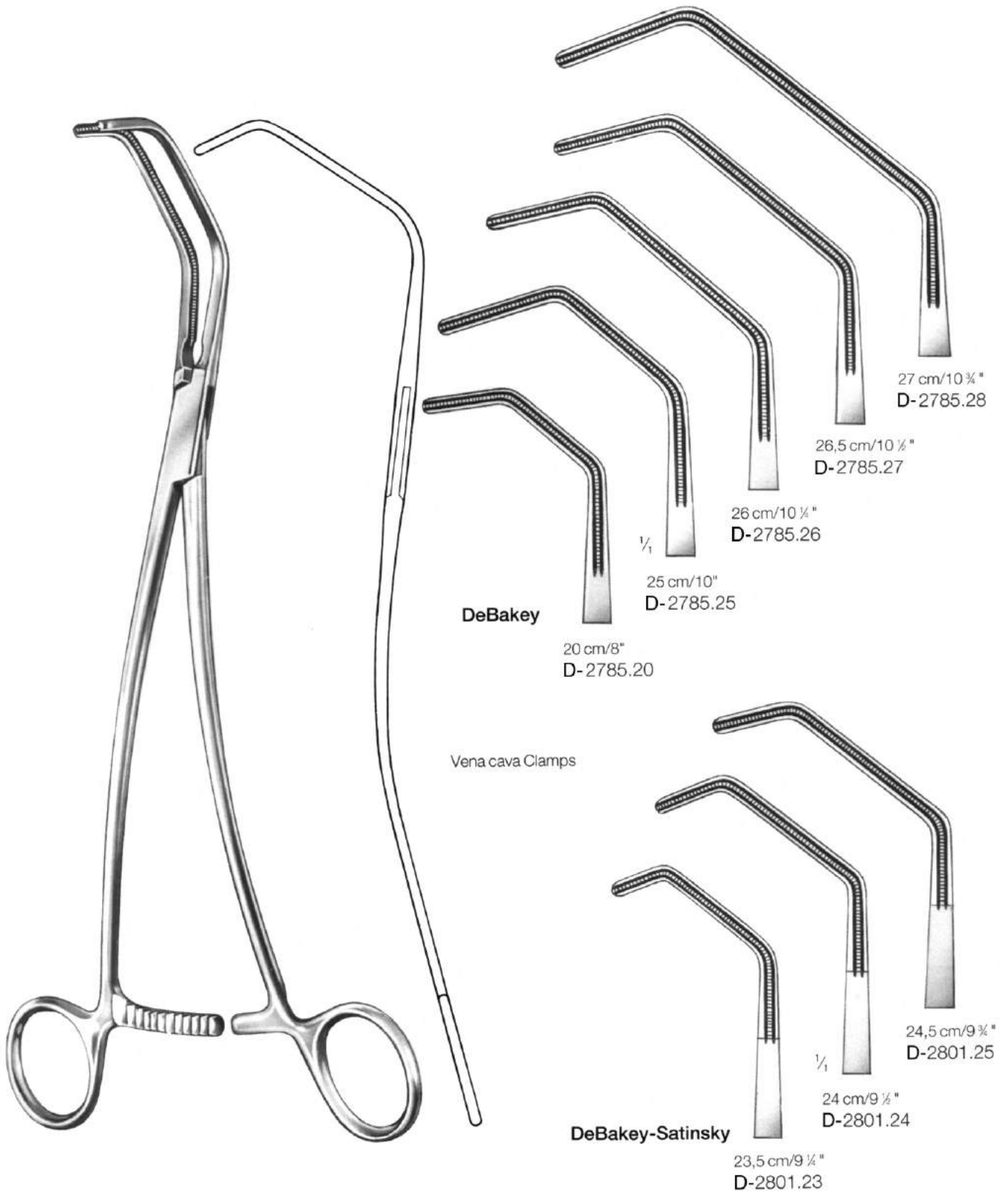

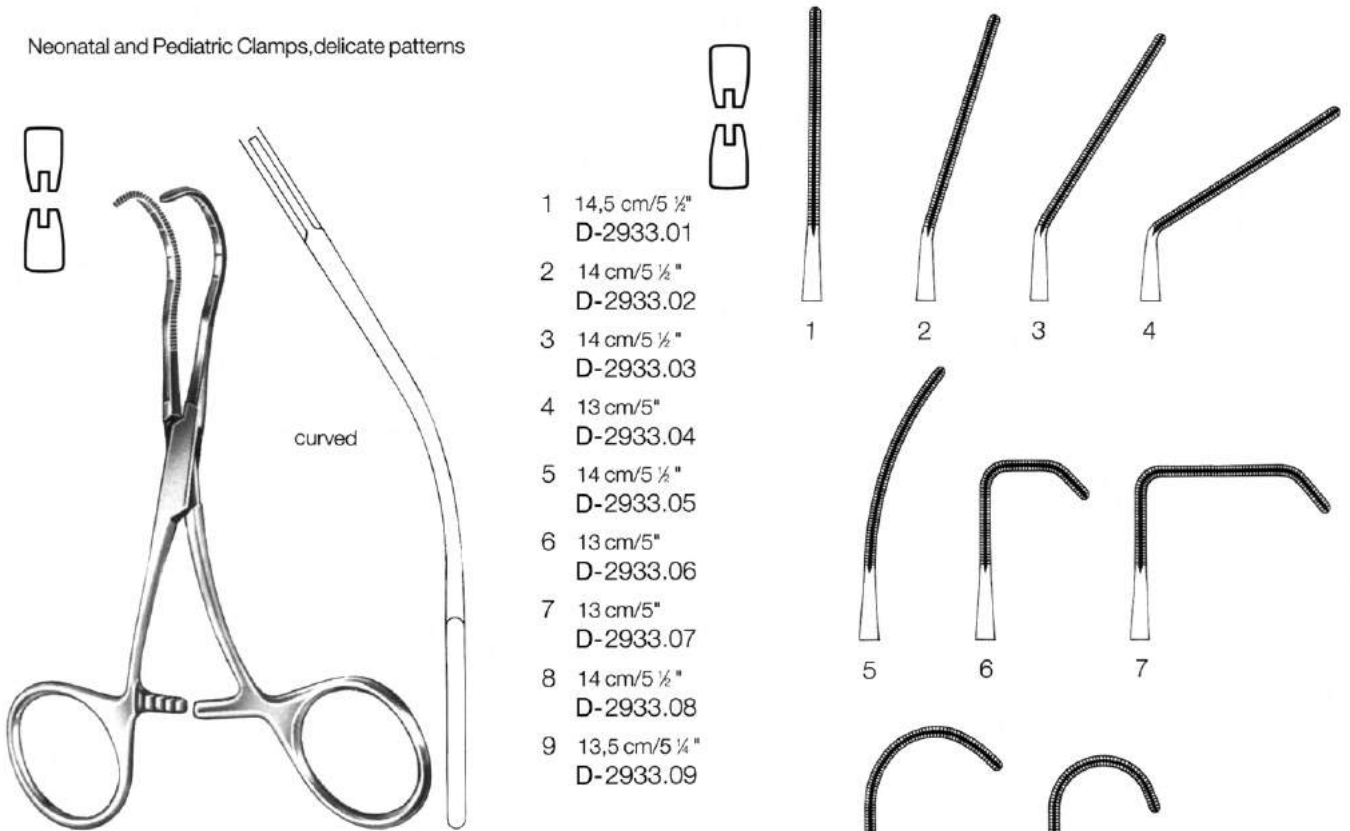

Neonatal and Pediatric Clamps, delicate patterns

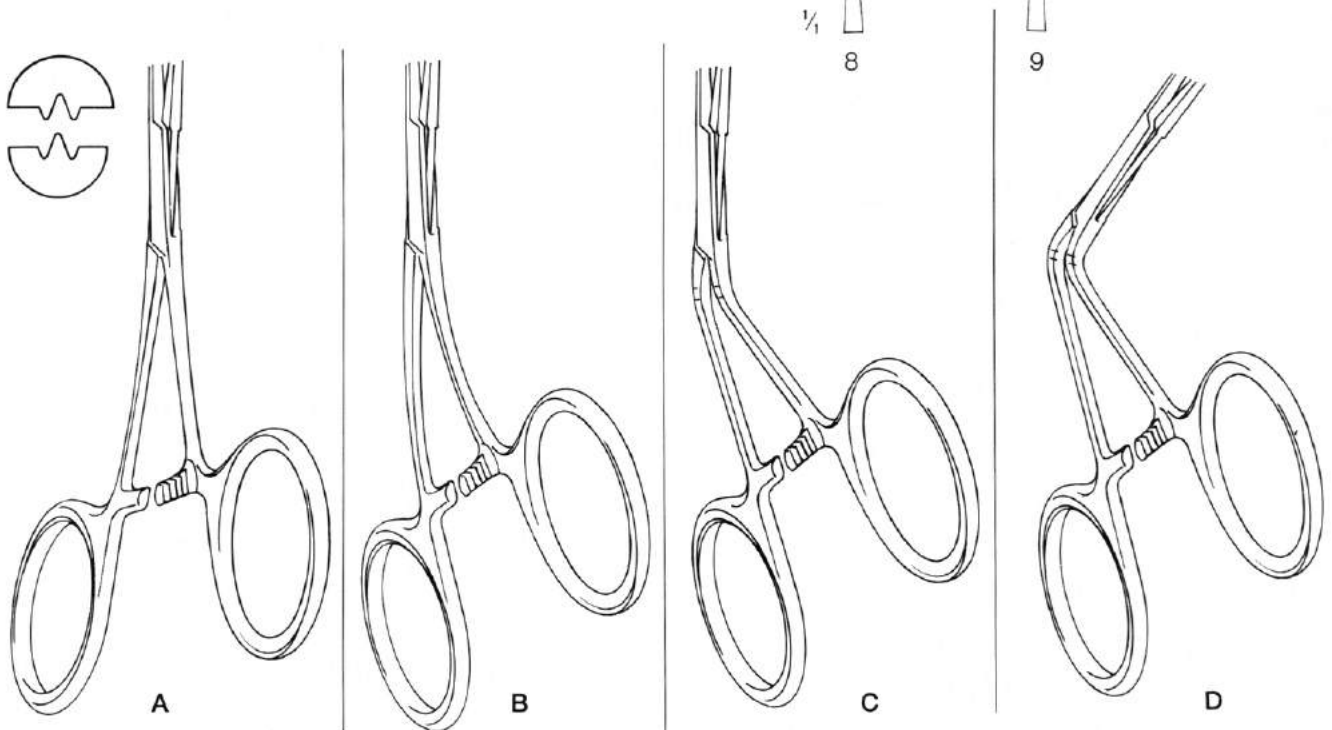

DeBAKEY-CASTANEDA Cardiovascular Clamps



DeBAKEY-CASTANEDA Cardiovascular Clamps



	1	2	3	4	5	6
A	D-2940.01	D-2940.02	D-2940.03	D-2940.04	D-2940.05	D-2940.06
B	D-2941.01	D-2941.02	D-2941.03	D-2941.04	D-2941.05	D-2941.06
C	D-2943.01	D-2943.02	D-2943.03	D-2943.04	D-2943.05	D-2943.06
D	D-2945.01	D-2945.02	D-2945.03	D-2945.04	D-2945.05	D-2945.06



	7	8	9	10	11	12
A	D-2940.07	D-2940.08	D-2940.09	D-2940.10	D-2940.11	D-2940.12
B	D-2941.07	D-2941.08	D-2941.09	D-2941.10	D-2941.11	D-2941.12
C	D-2943.07	D-2943.08	D-2943.09	D-2943.10	D-2943.11	D-2943.12
D	D-2945.07	D-2945.08				



	13	14	15	16	17	18
A	D-2940.13	D-2940.14	D-2940.15	D-2940.16	D-2940.17	D-2940.18
B	D-2941.13	D-2941.14	D-2941.15	D-2941.16	D-2941.17	D-2941.18
C	D-2943.13	D-2943.14	D-2943.15	D-2943.16	D-2943.17	D-2943.18

Anastomosis Forceps



D-3085.01



D-3085.02



D-3085.03

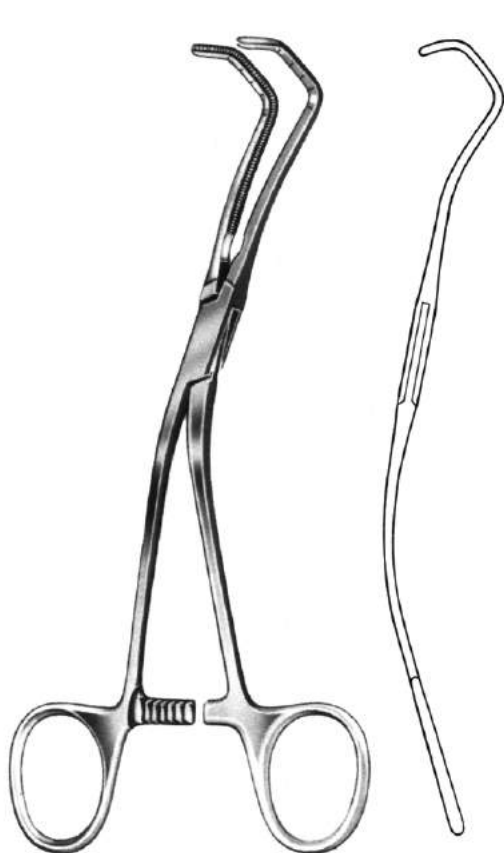

DeBakey
 17 cm/6 3/4" *
 D-3051.17

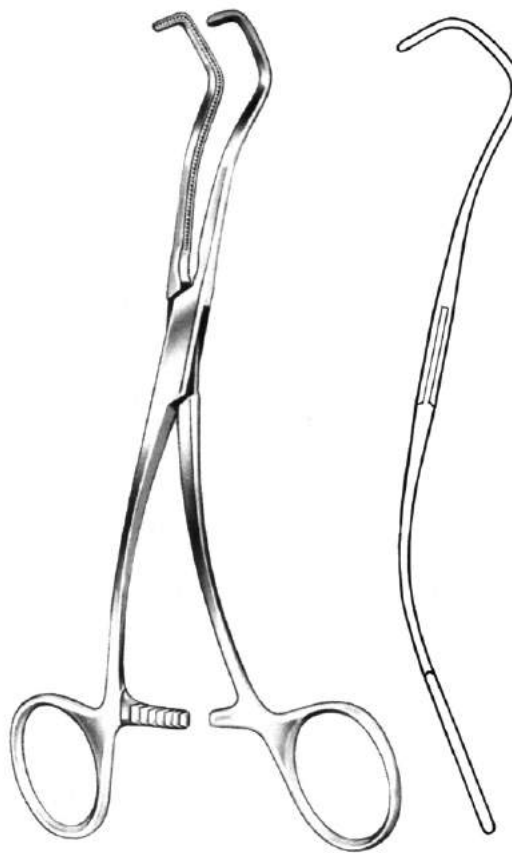

DeBakey-Derra
 17 cm/6 3/4" *

Anastomosis Forceps

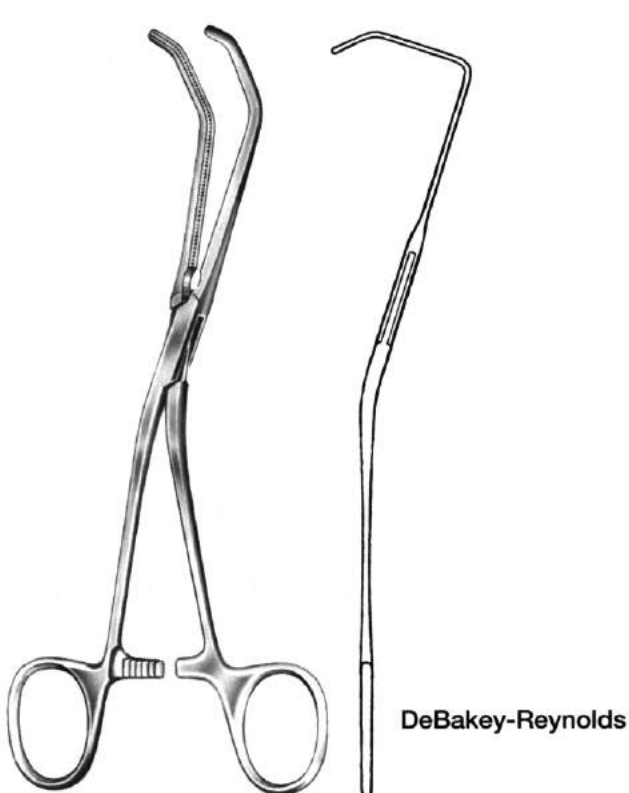
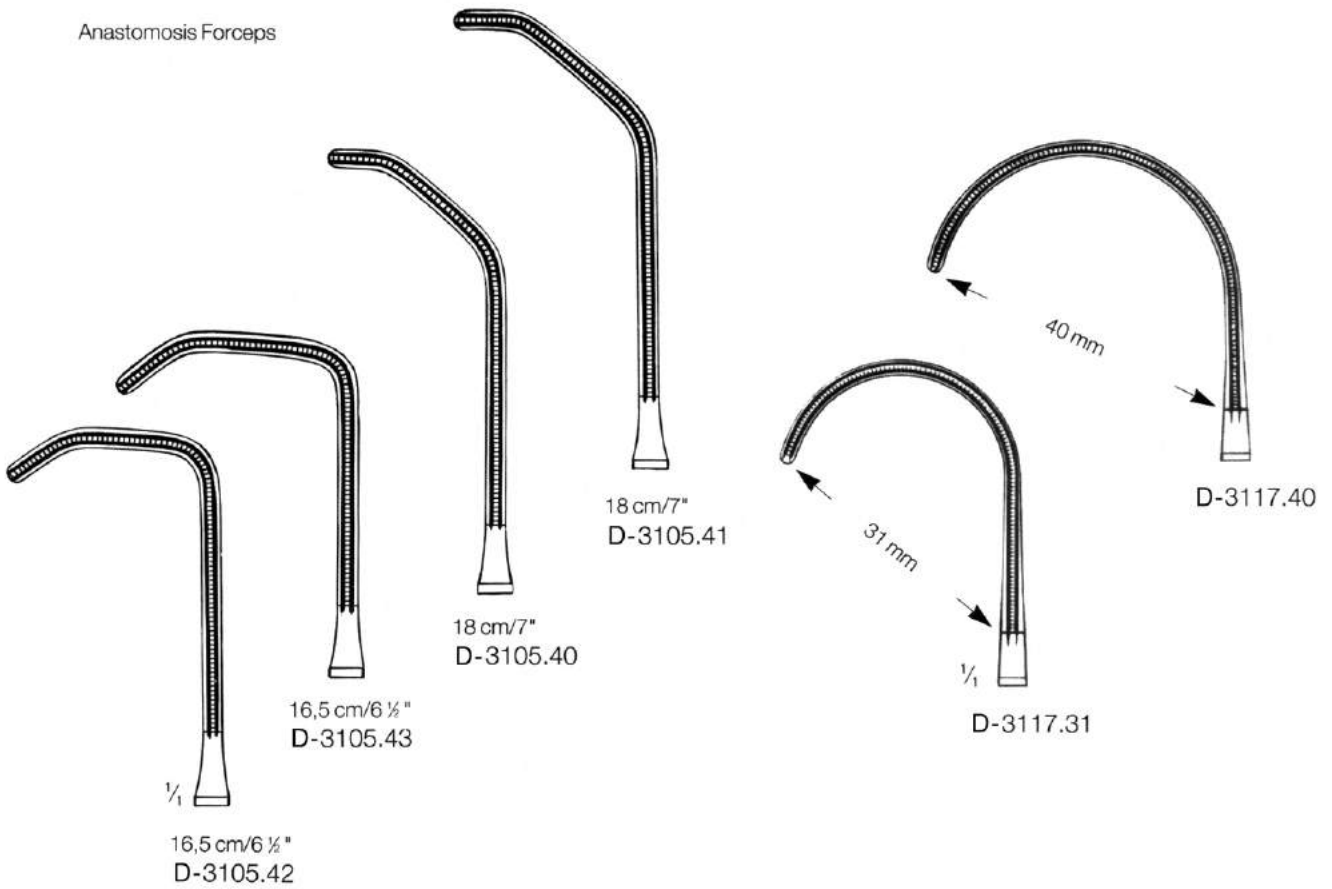

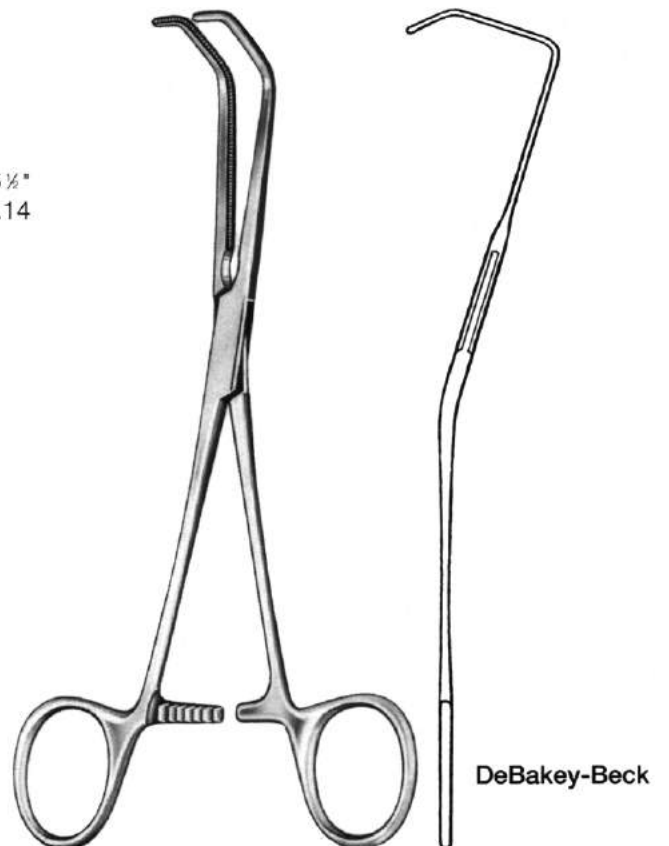
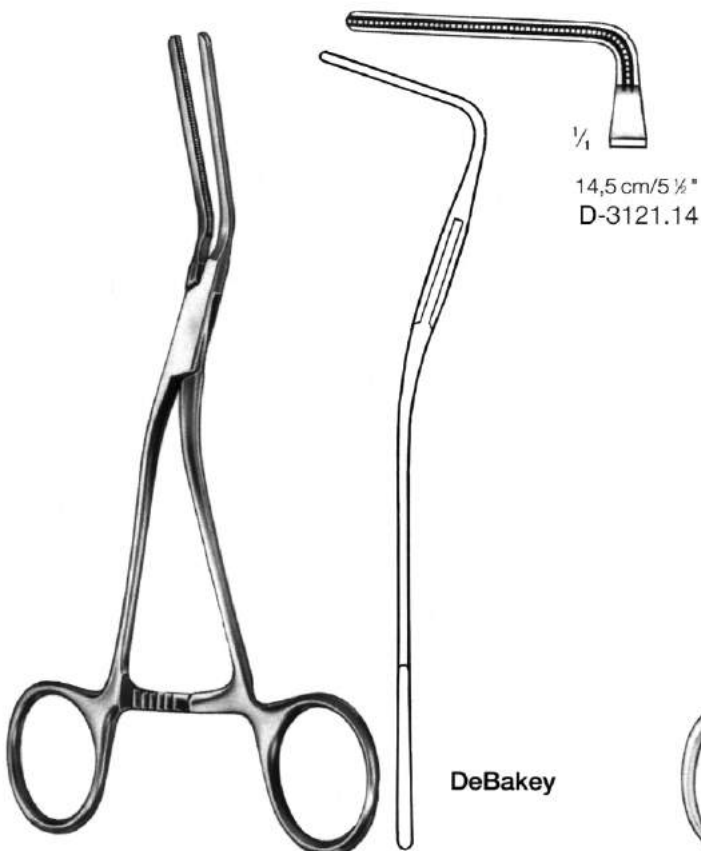
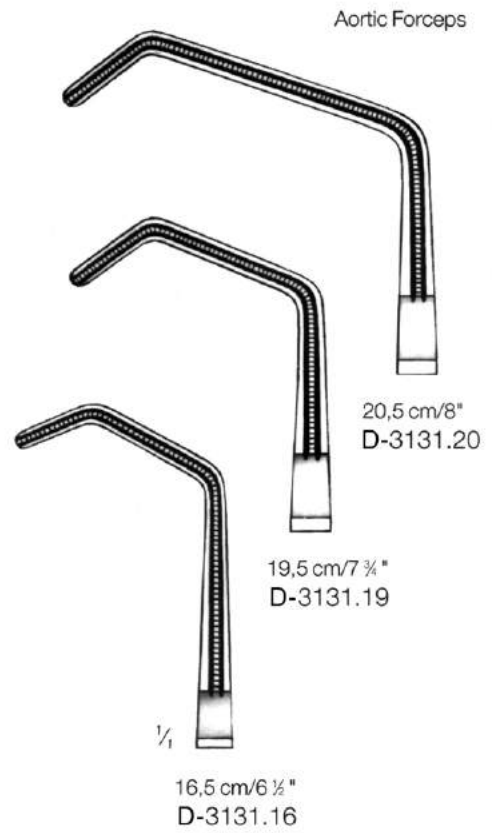
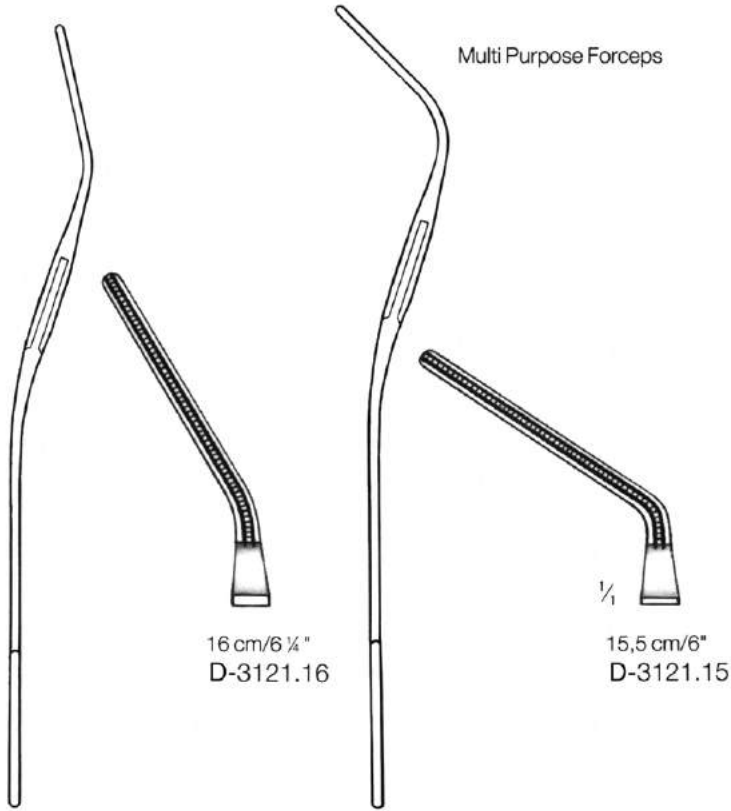

Coarctation Forceps

Patent Ductus Forceps

Patent Ductus Forceps



$\frac{1}{4}$
 17 cm/6 $\frac{3}{8}$ "
 D-3200.17

DeBailey



16,5 cm/6 $\frac{1}{2}$ "
 D-3205.16

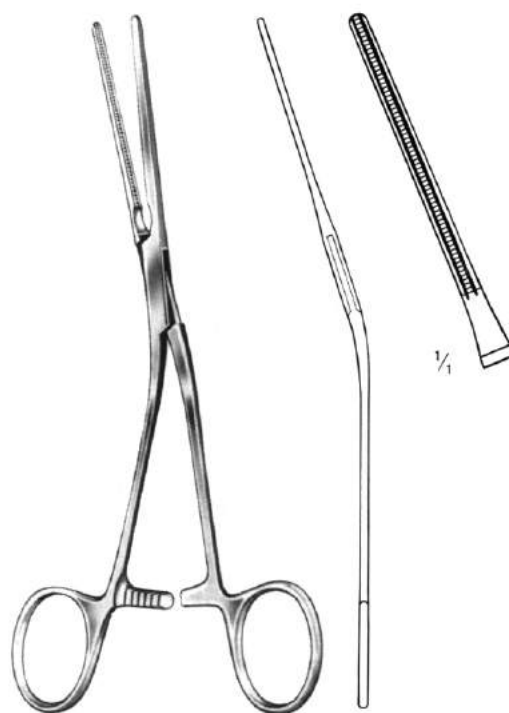

DeBailey
 16,5 cm/6 $\frac{1}{2}$ "
 D-3201.16

Anastomosis Forceps

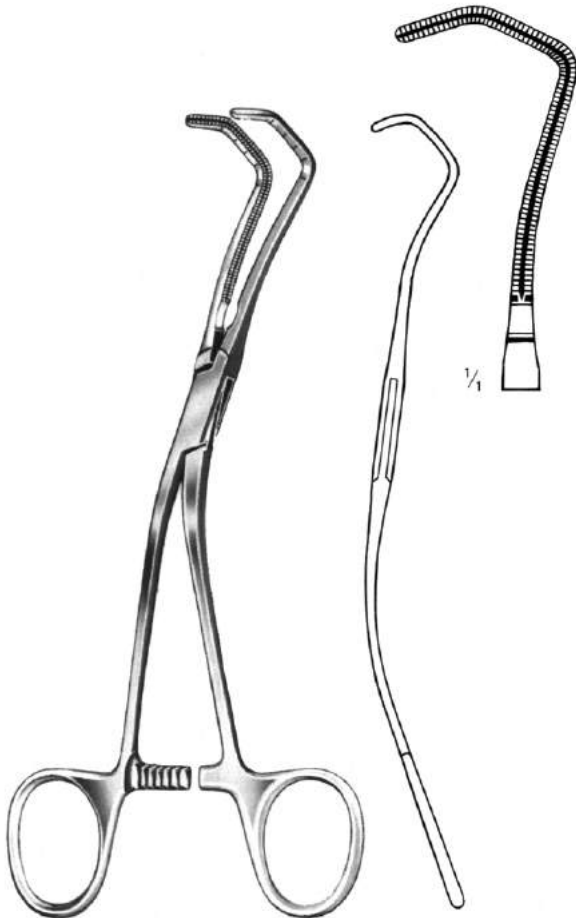
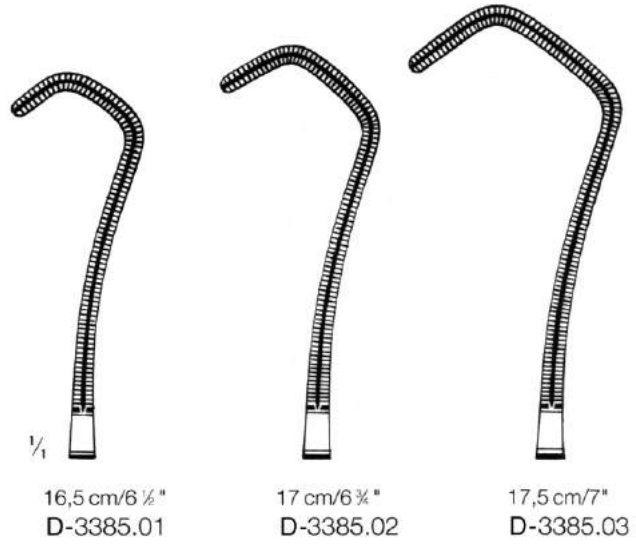

Cooley
 17 cm/6 3/4"
 D-3351.17

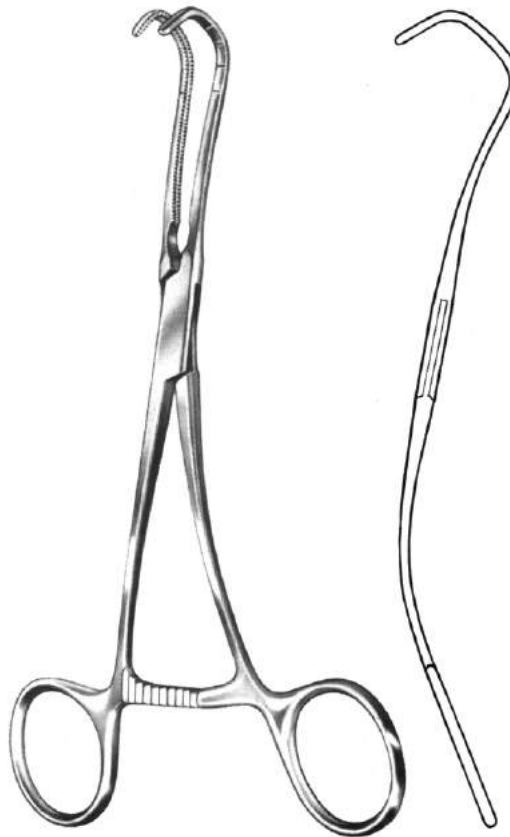

Cooley-Derra

Anastomosis Forceps

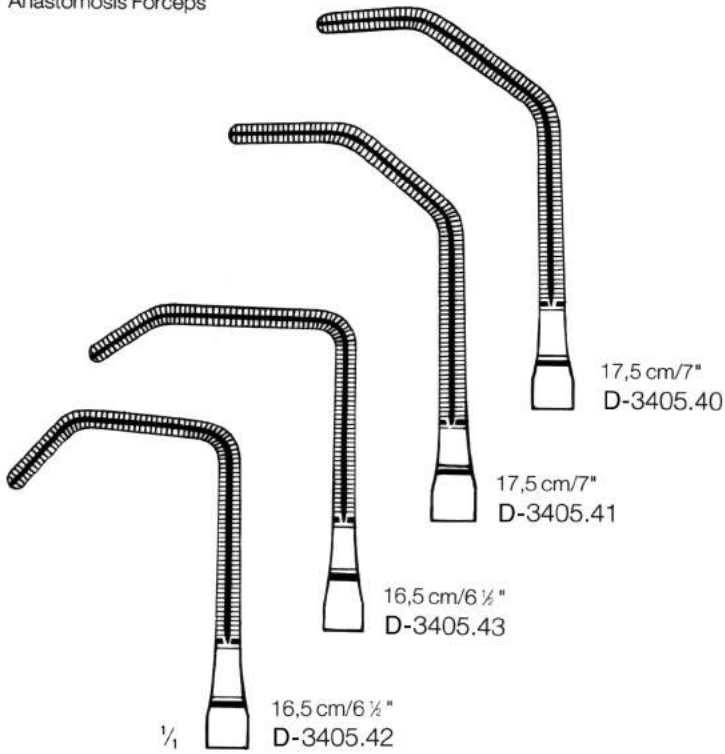

Ligature Carriers

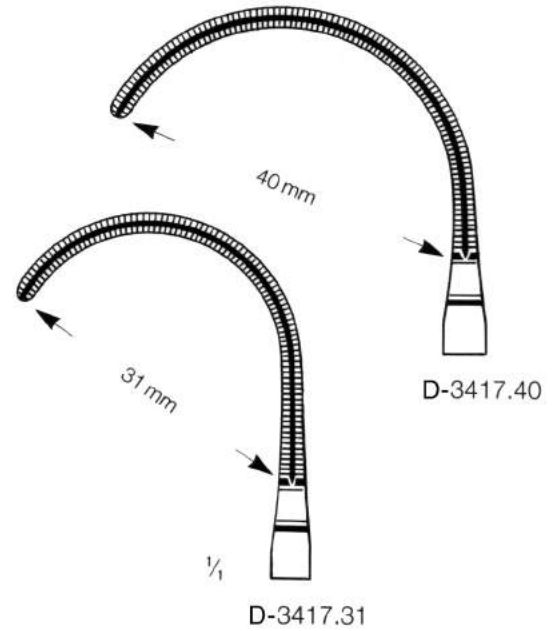

Cooley



Cooley
 17 cm/6 3/4"

Multi Purpose Forceps



Cooley

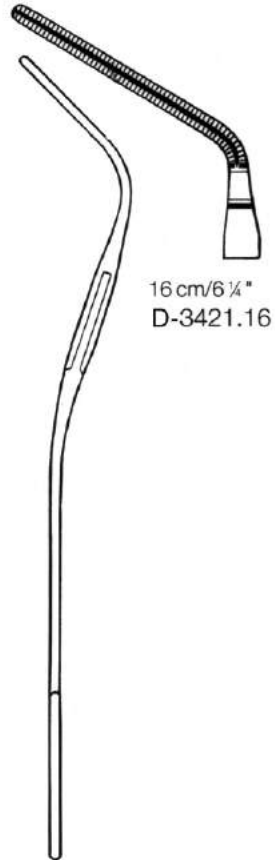
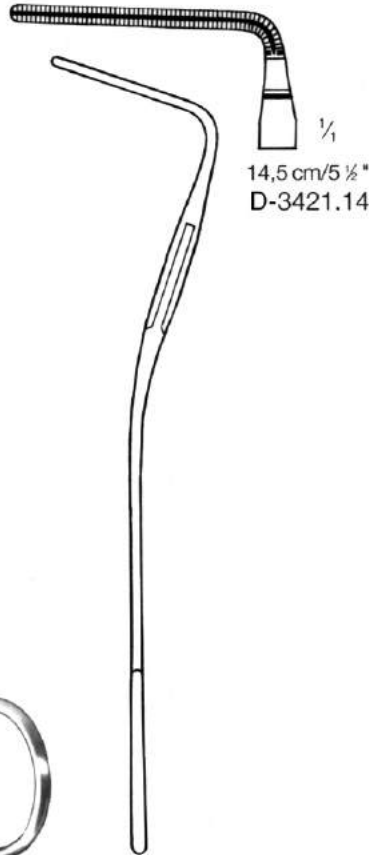

Cooley-Beck

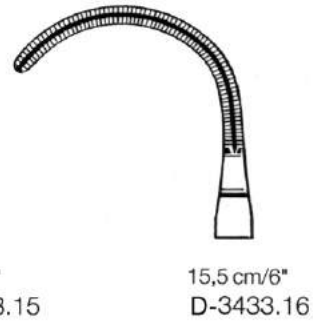
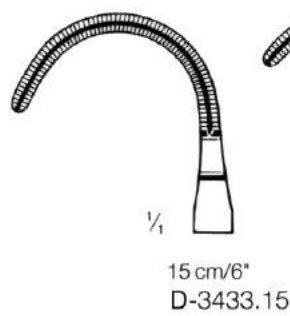

Vascular Clamps

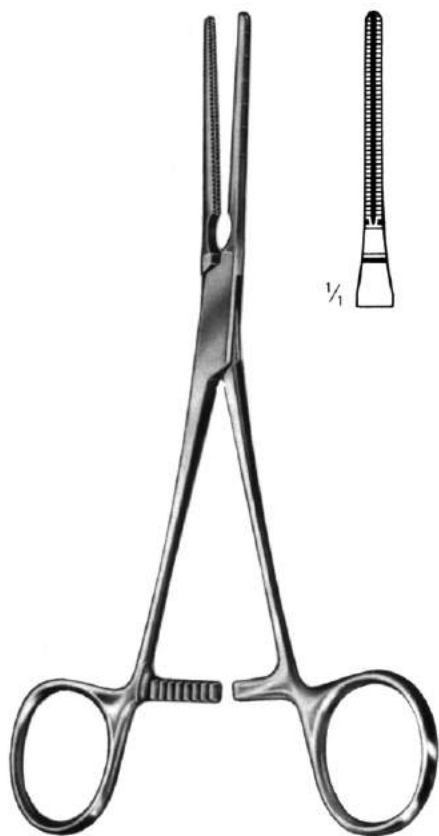

Cooley
16 cm/6 $\frac{1}{4}$ "
D-3500.16



Cooley
16 cm/6 $\frac{1}{4}$ "
D-3501.16

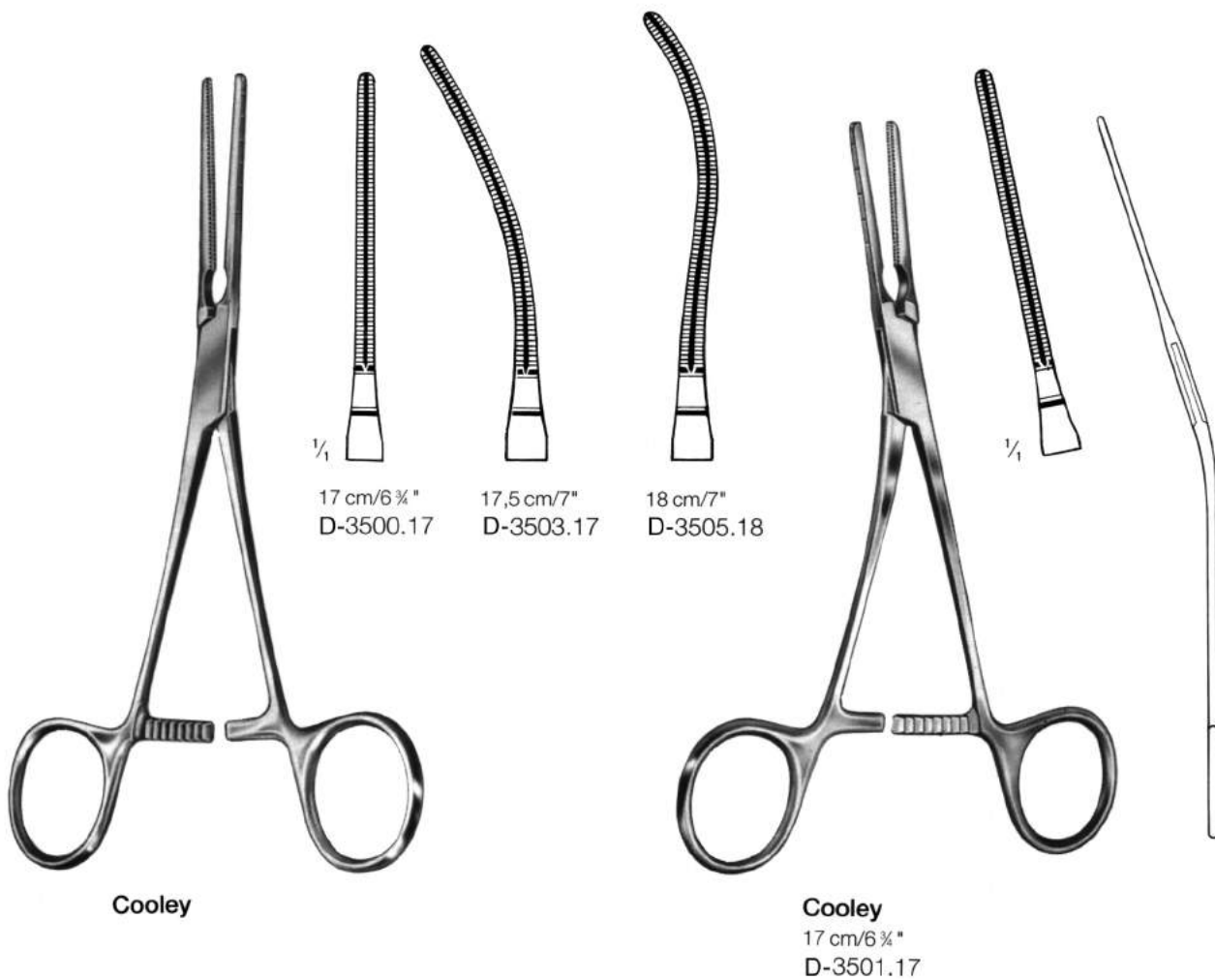

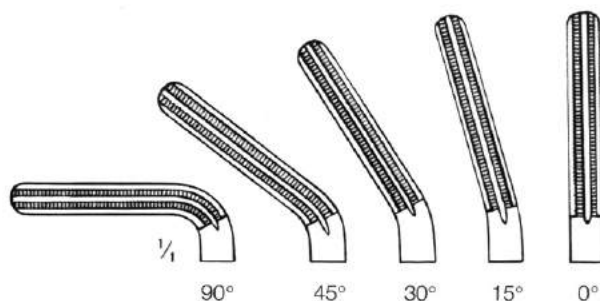

Weight

	cm	inch.	◁	Weight
D-3915.00	15	6	0°	28 g
D-3915.15	15	6	15°	28 g
D-3915.30	15	6	30°	28 g
D-3915.45	15	6	45°	28 g
D-3915.90	14	5 ½	90°	28 g

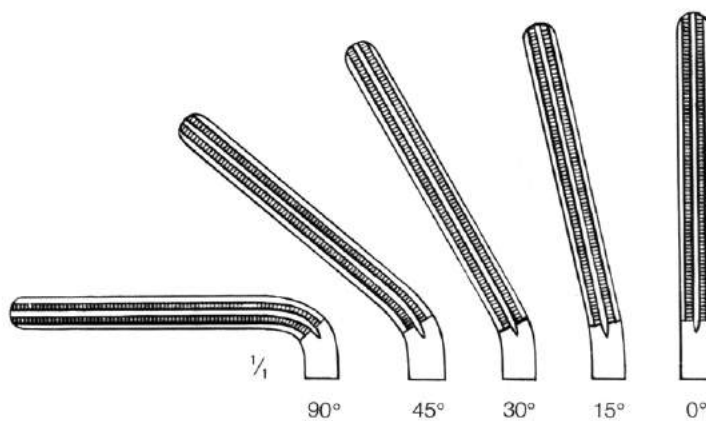
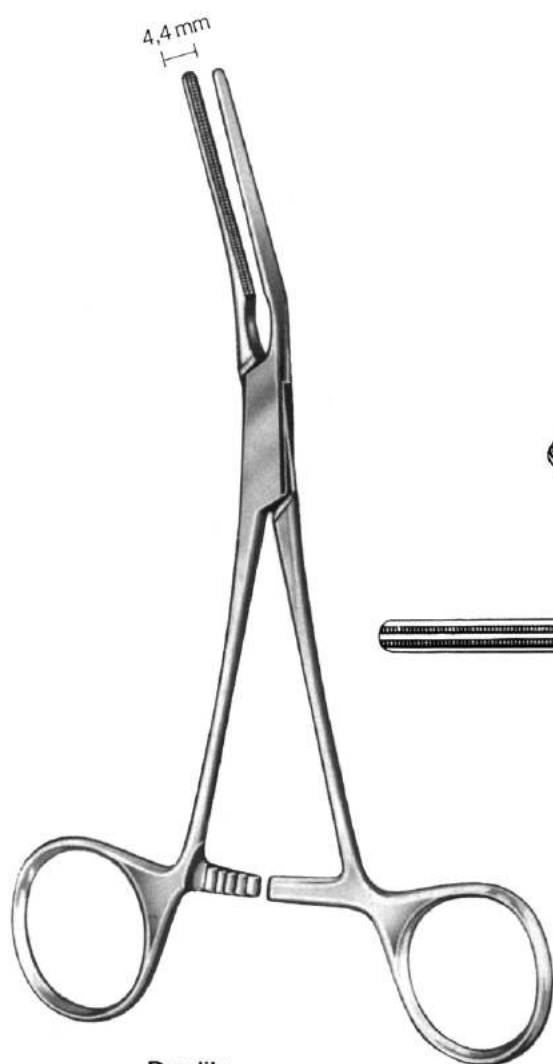

Weight

	cm	inch.	◁	Weight
D-3917.00	17	6 ¾	0°	28 g
D-3917.15	17	6 ¾	15°	28 g
D-3917.30	17	6 ¾	30°	28 g
D-3917.45	17	6 ¾	45°	28 g
D-3917.90	16	6 ¼	90°	28 g

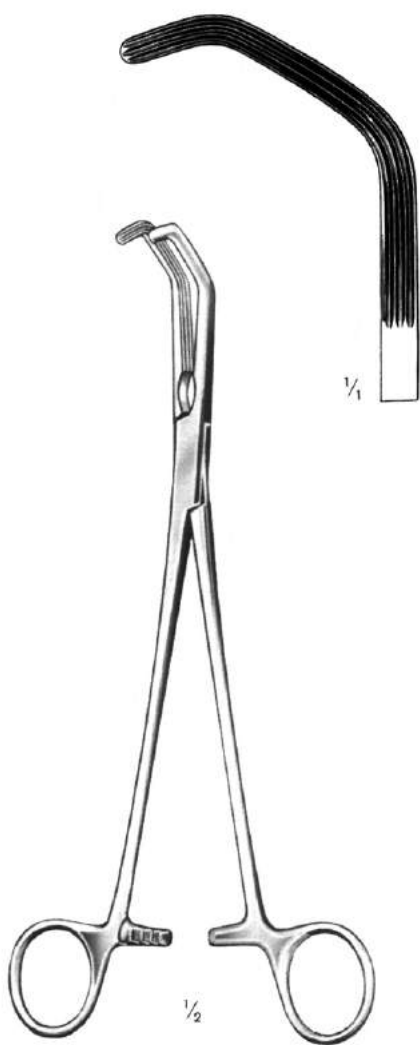

Price-Thomas
 22 cm/8 3/4"
 D-3957.22

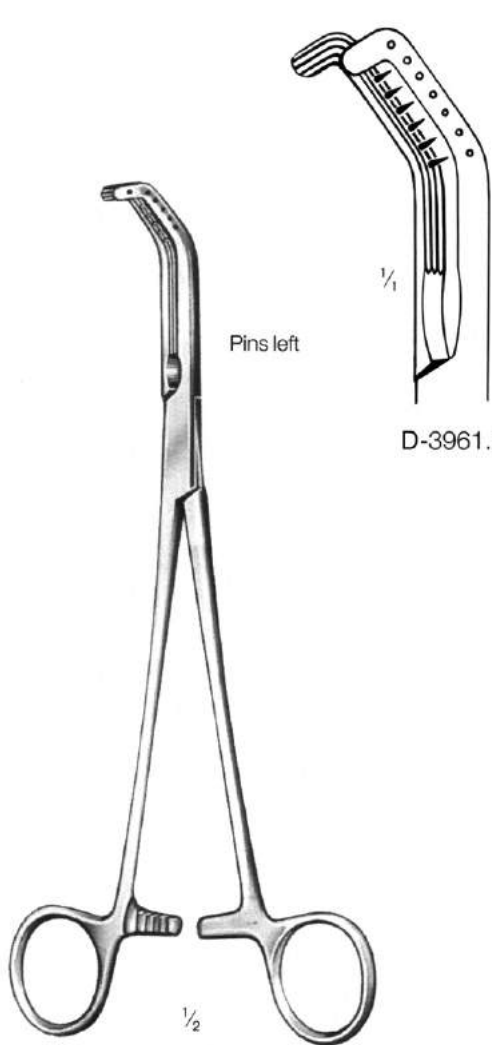

Price-Thomas
 22 cm/8 3/4"

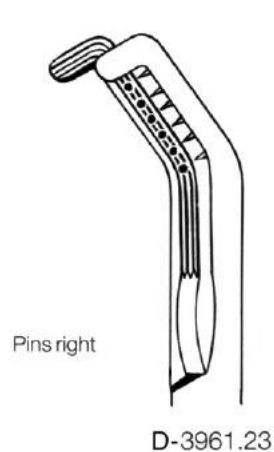

D-3961.23

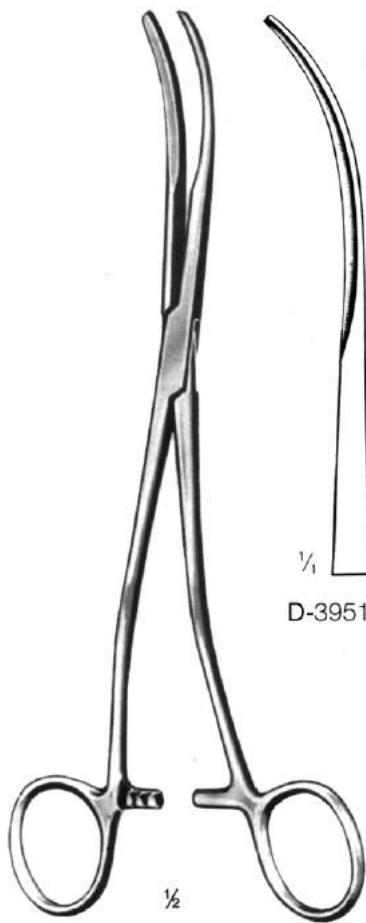

Semb
 24 cm/9 1/2"

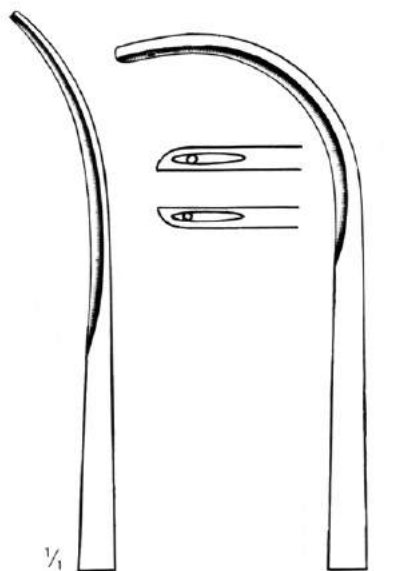

D-3951.24

D-3951.23

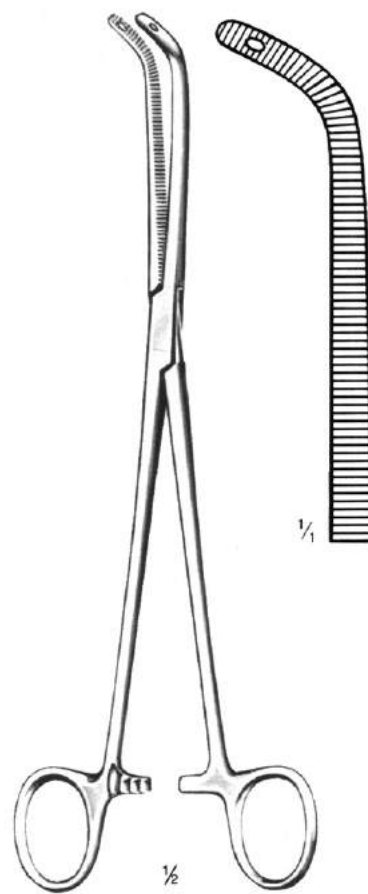

Finocchietto
 24 cm/9 1/2"
 D-3955.25

Pylorus Separator



Benson
 15 cm/6"
 D-4005.15

Appendectomy Clamps

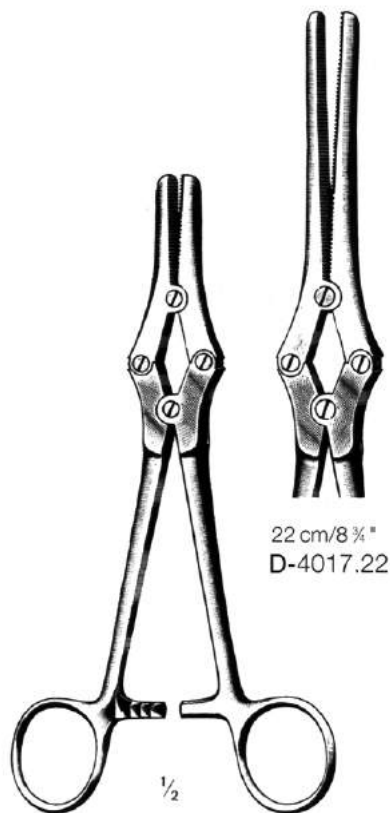

Zweifel
 17 cm/6 ¾"
 D-4017.17

Appendectomy Clamp and Spur Crusher



Kleinschmidt
 12 cm/4 ¾"
 D-4023.12

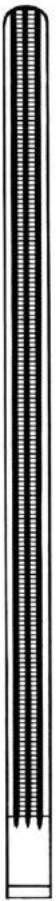
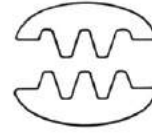
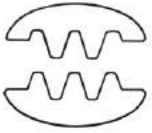

25 cm/10"
D-4124.25



25 cm/10"
D-4120.25



21 cm/8 1/4"
D-4120.21

23 cm/9"
D-4120.23

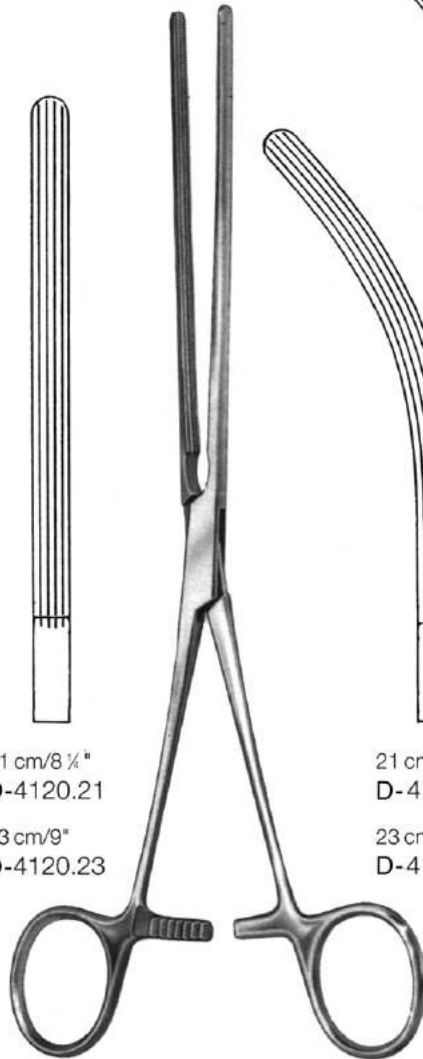

Mayo-Robson

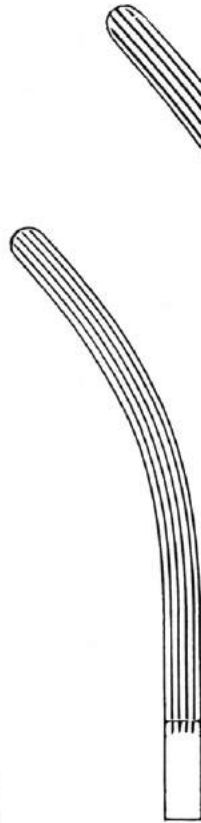

21 cm/8 1/4"
D-4121.21

23 cm/9"
D-4121.23



25 cm/10"
D-4121.25

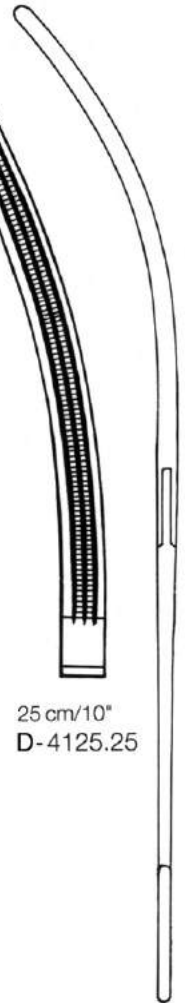

25 cm/10"
D-4125.25



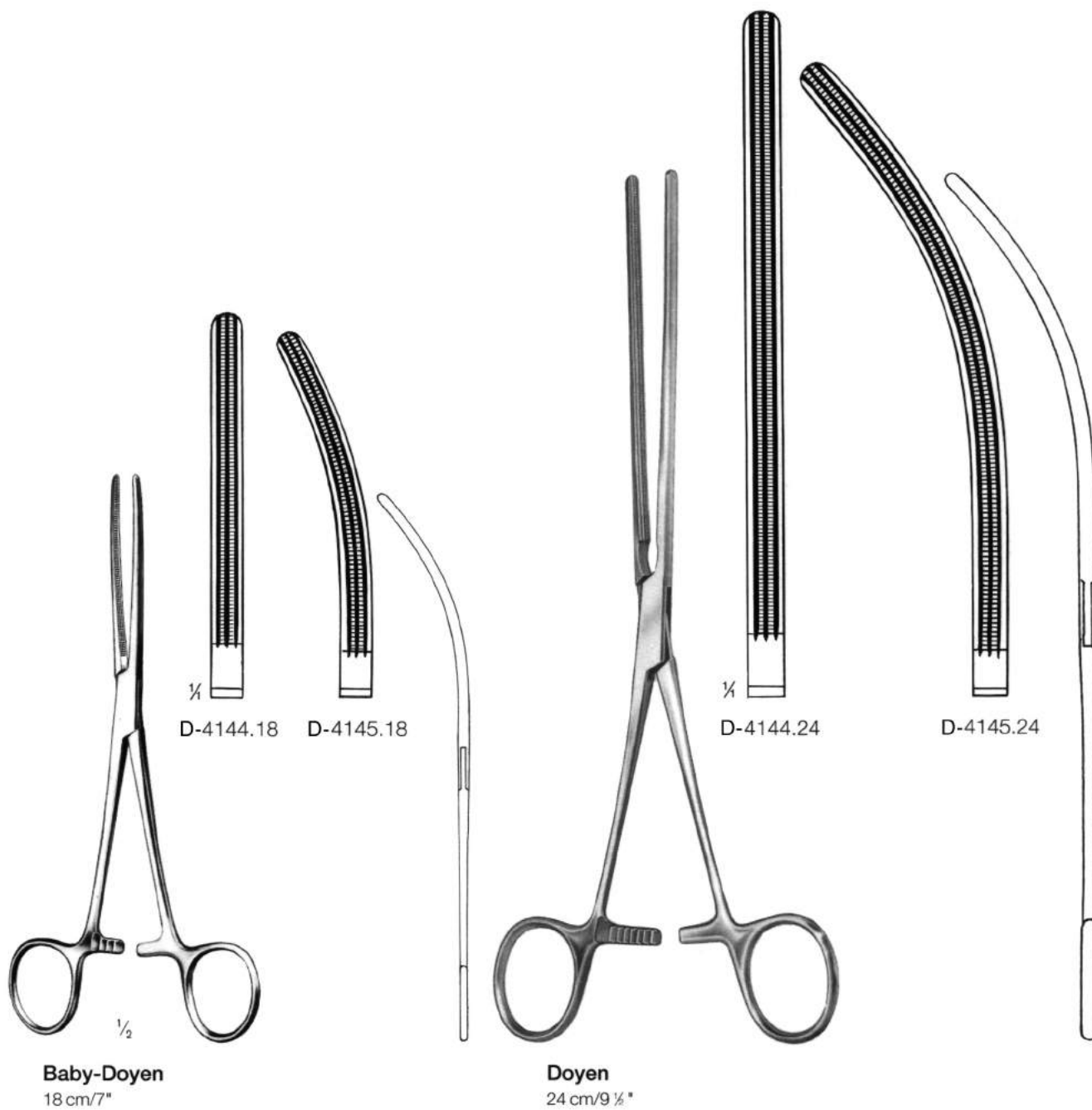

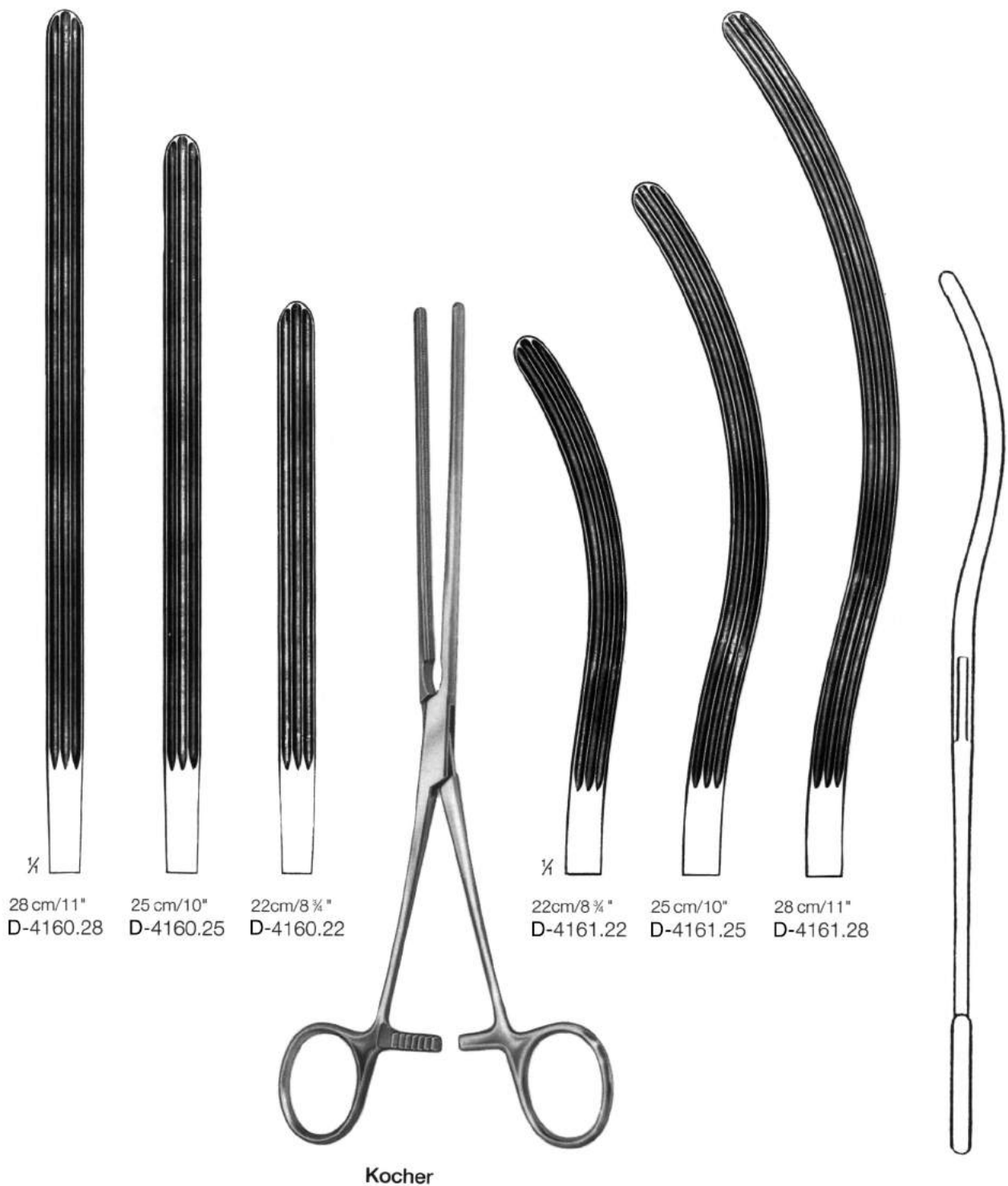

Intestinal clamp forceps
 pinces-clamps pour l'intestin
 pinzas-clamps intestiales

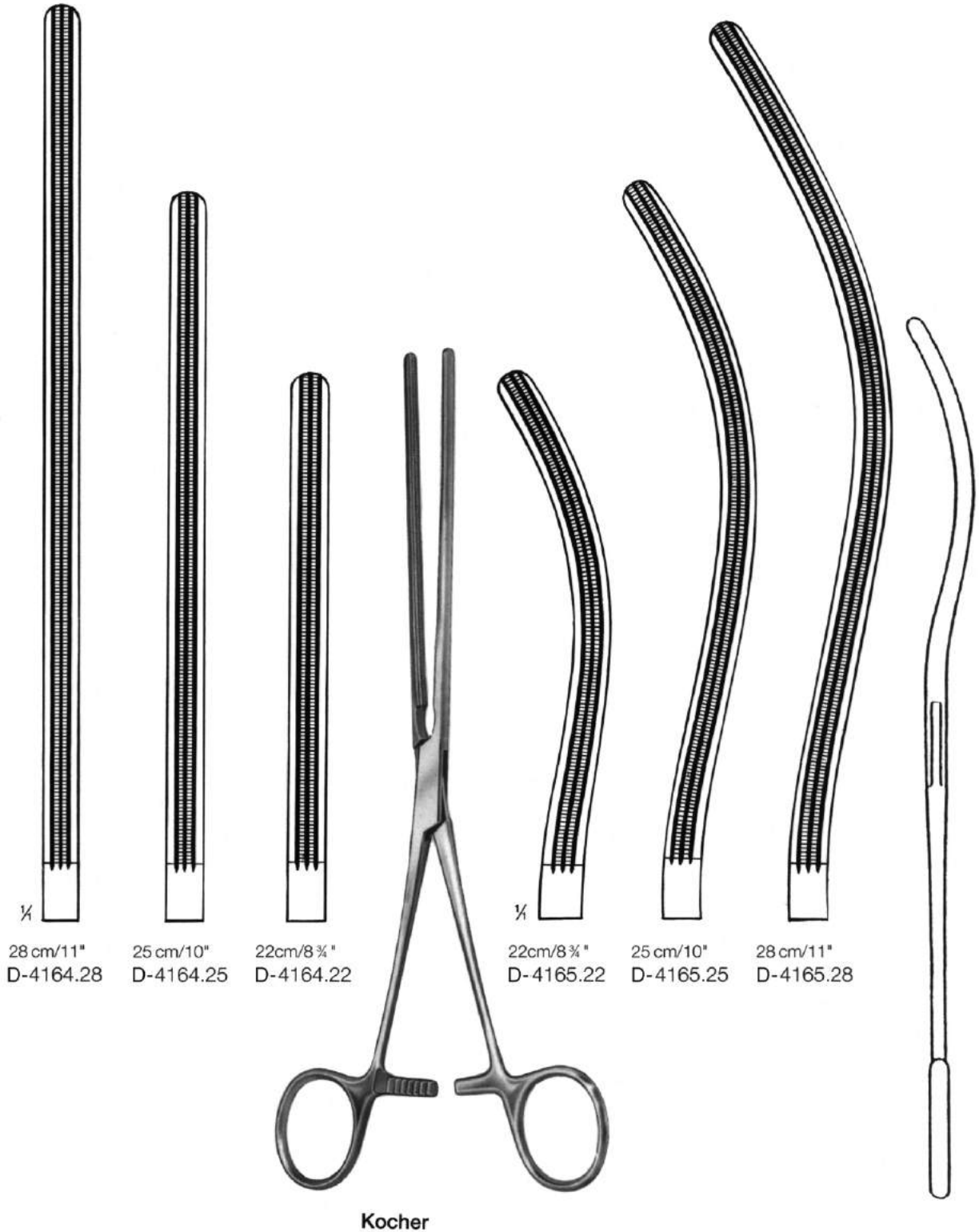

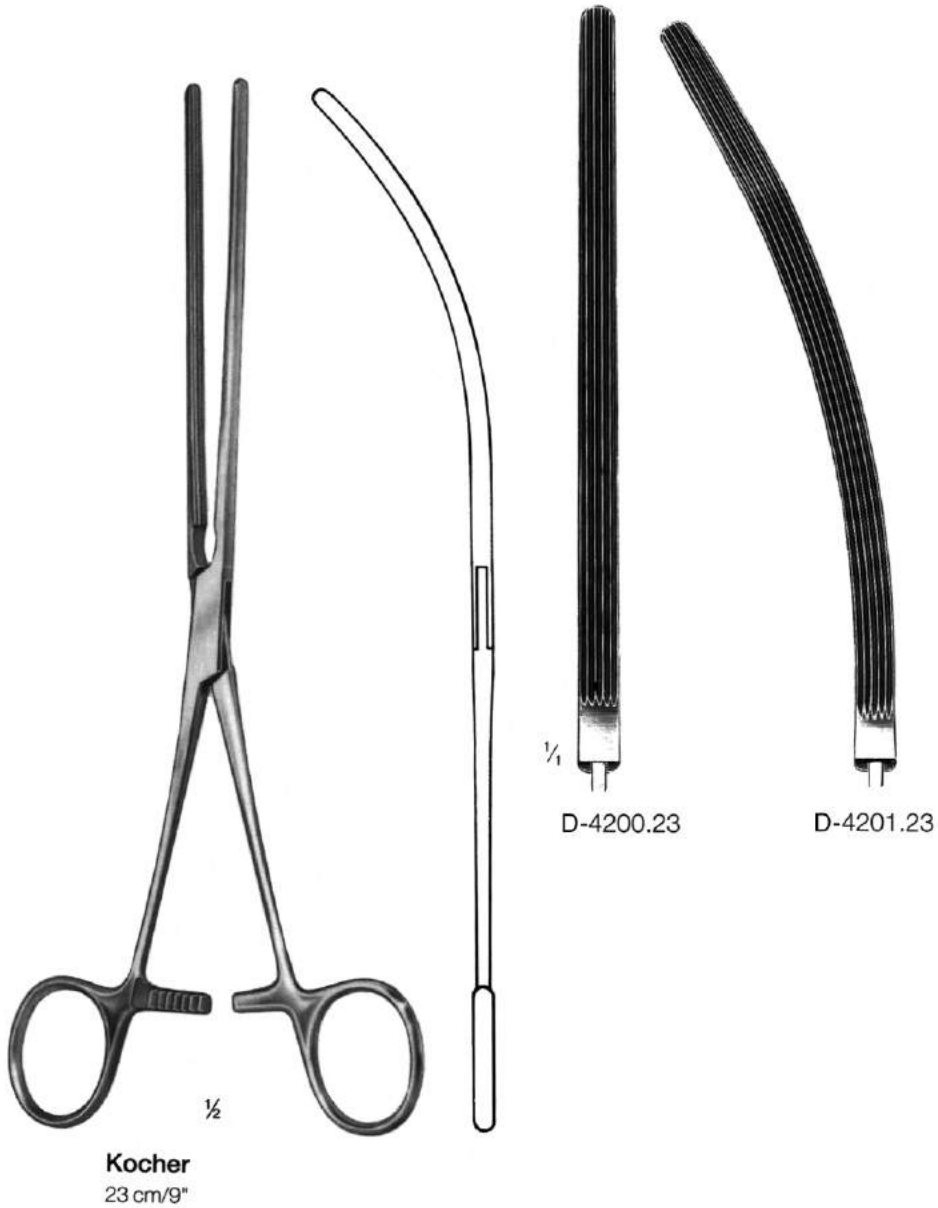

smooth jaws

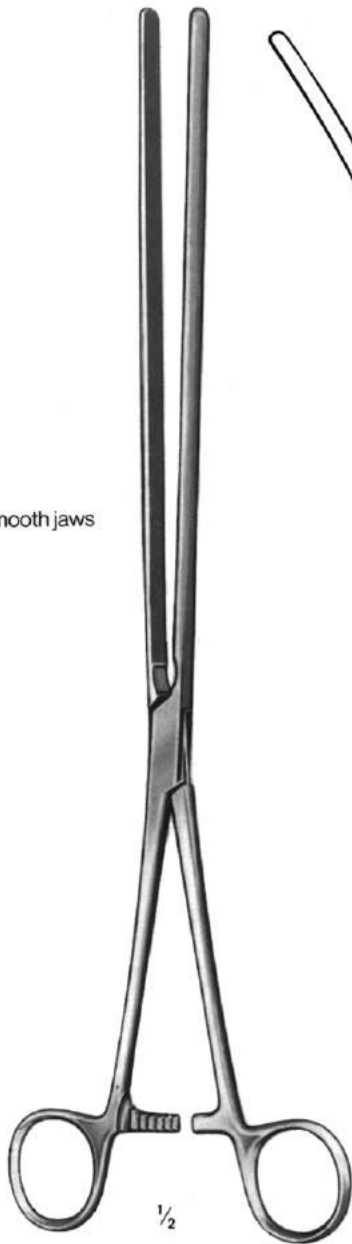

Scudder
33 cm/13"

$\frac{1}{2}$

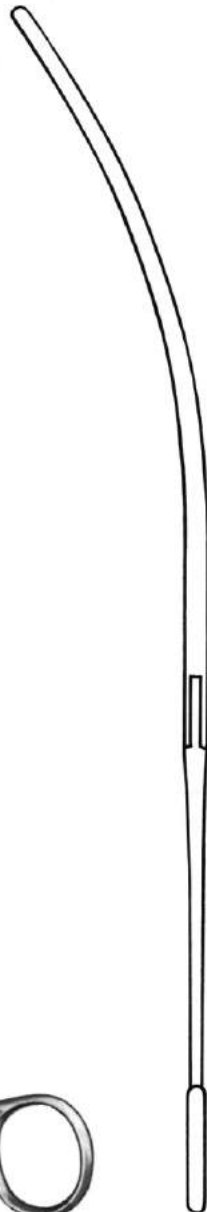

$\frac{1}{4}$

D-4230.33

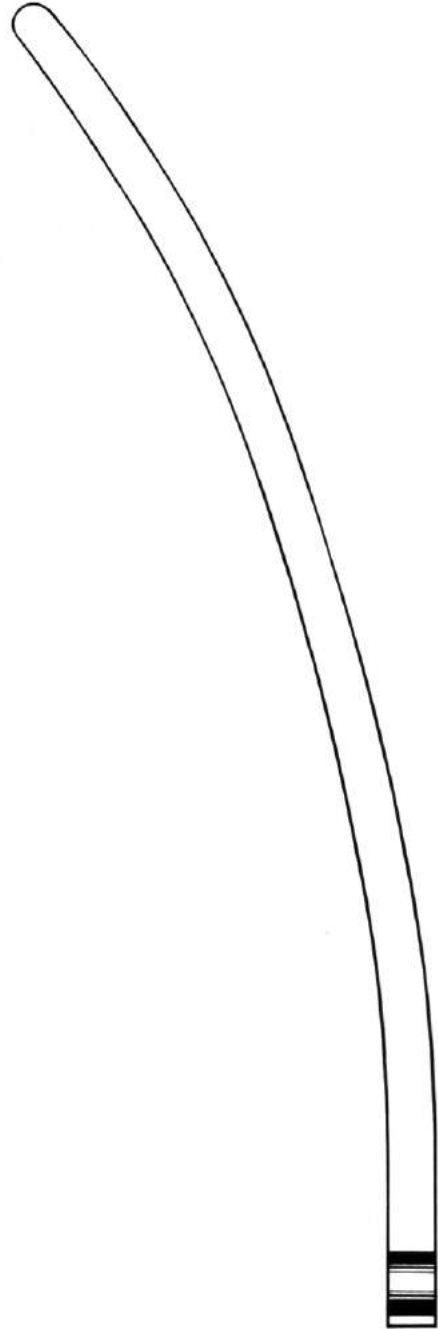

D-4231.33

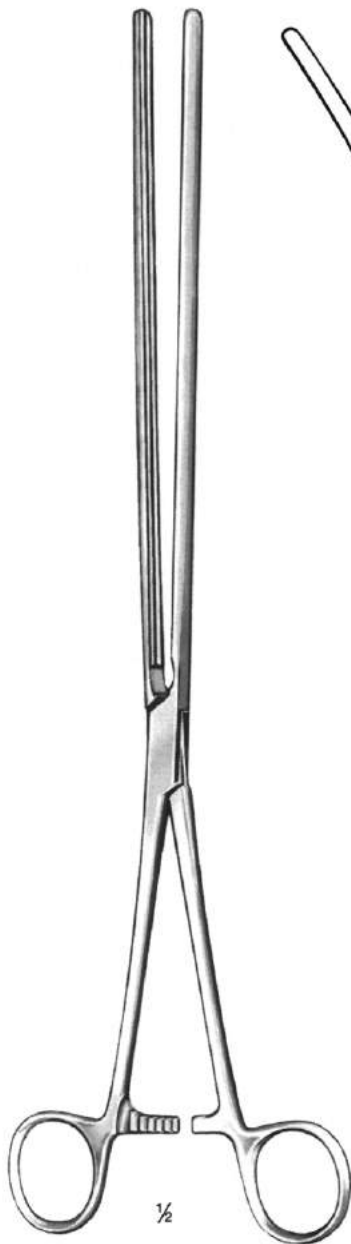

Scudder
33 cm/13"

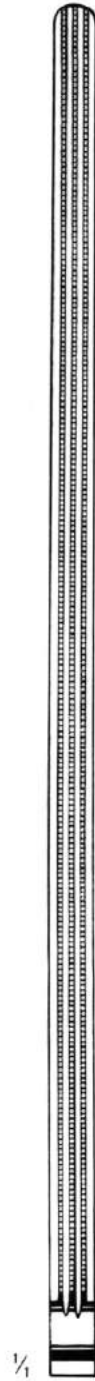
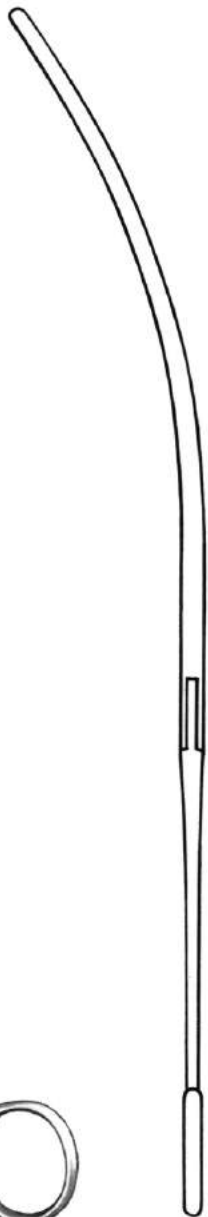

D-4234.33

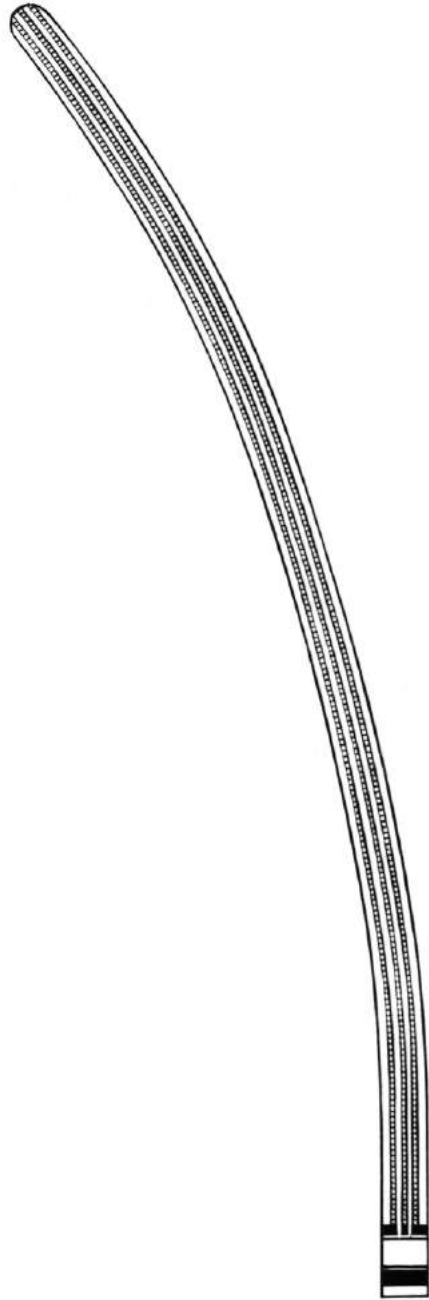

D-4235.33

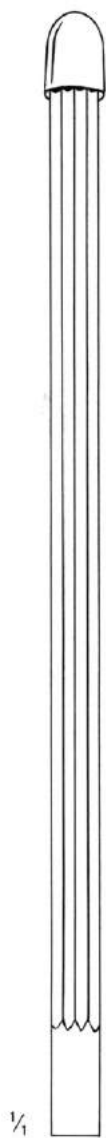

$\frac{1}{4}$
30,5 cm/12"
D-4300.30

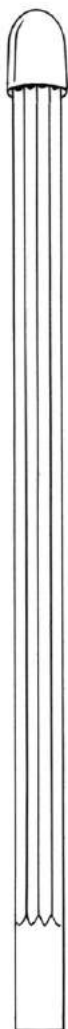

25,5 cm/10"
D-4300.25

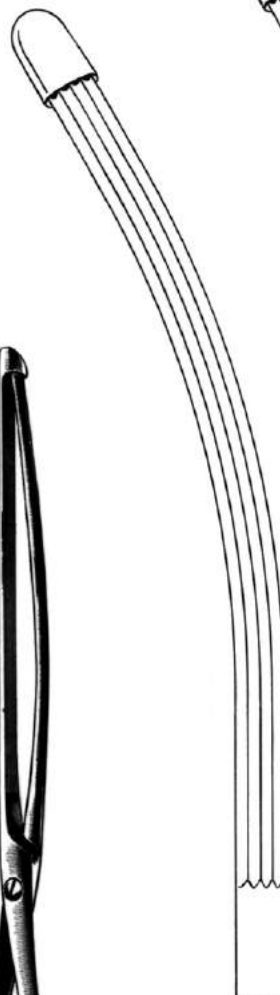

25,5 cm/10"
D-4301.25

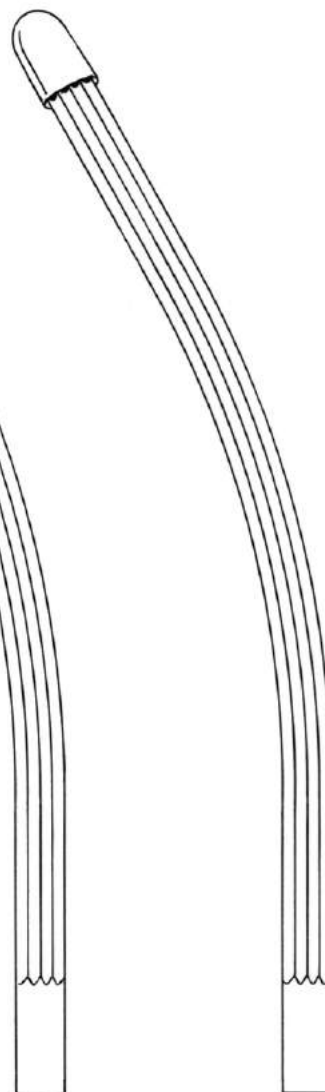

30,5 cm/12"
D-4301.30



Nussbaum

**Stomach clamp forceps
pincers-clamps stomacales
pinzas-clamps estomacales**



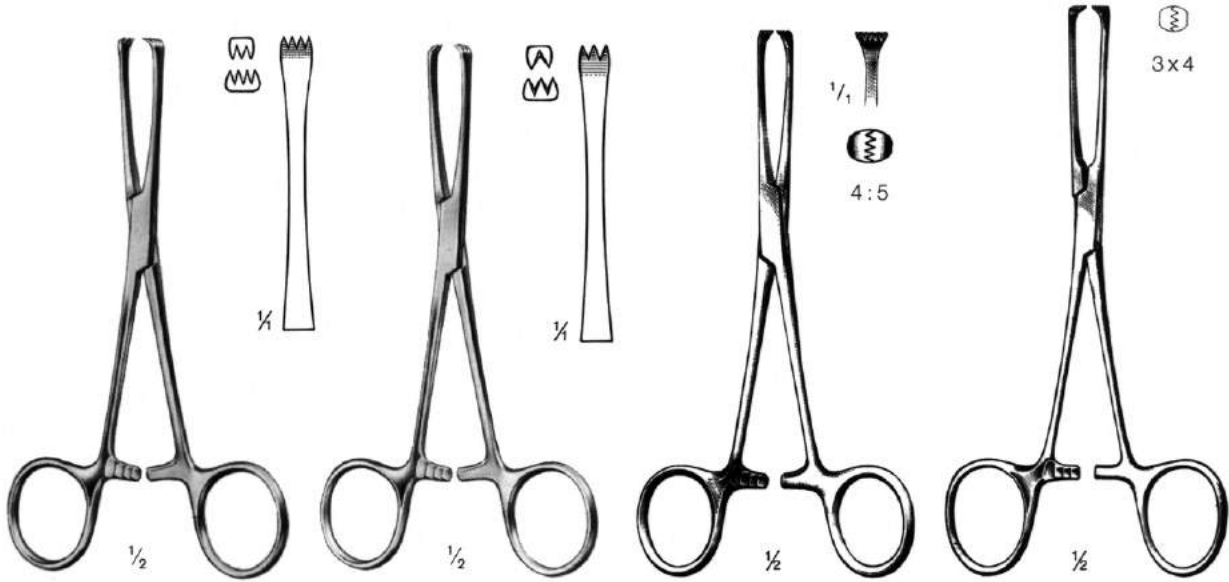

Tuffier
 13 cm/5"
 D-4310.13

Chaput
 13 cm/5"
 D-4312.13

Allis-Baby
 14 cm/5 1/2"
 D-4322.14

Allis
 15 cm/6"
 D-4328.15

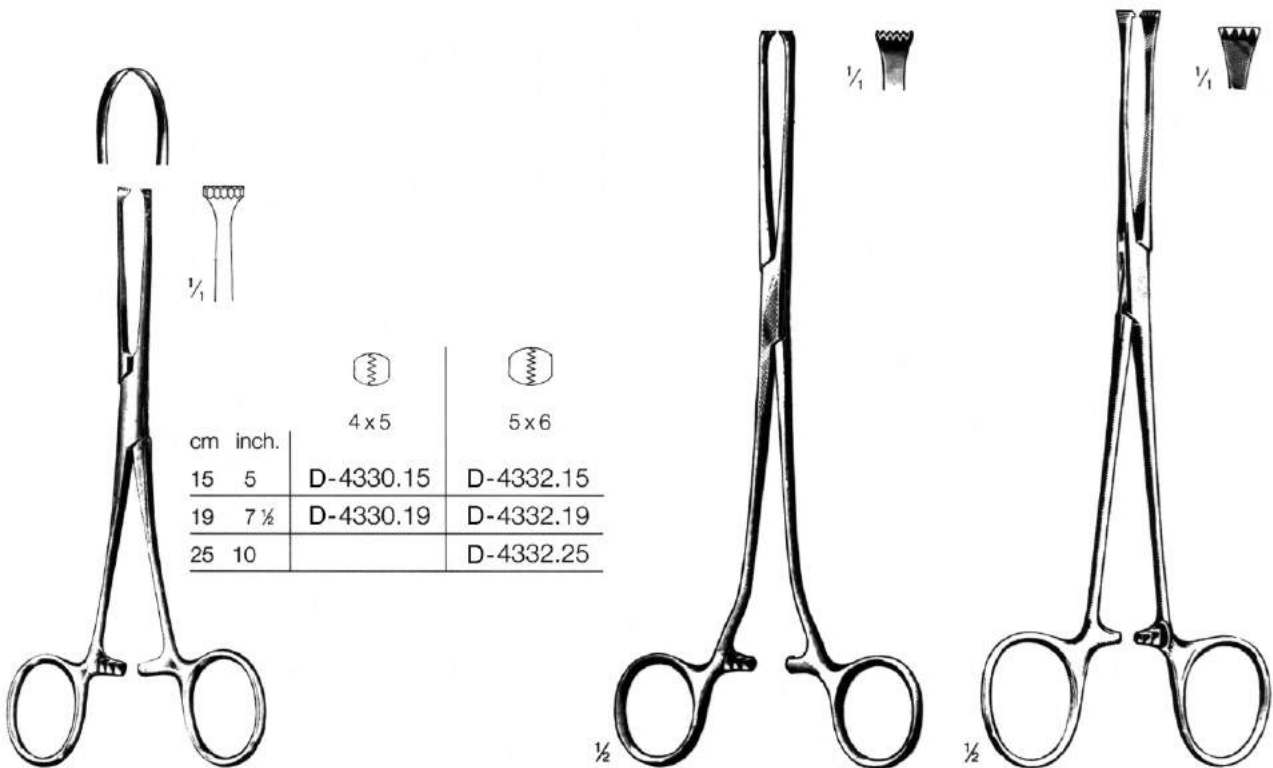

cm	inch.	4 x 5	5 x 6
15	5	D-4330.15	D-4332.15
19	7 1/2	D-4330.19	D-4332.19
25	10		D-4332.25

Allis

Allis
 20 cm/8"
 D-4334.20

Lockwood-Allis
 20 cm/8"
 D-4346.20

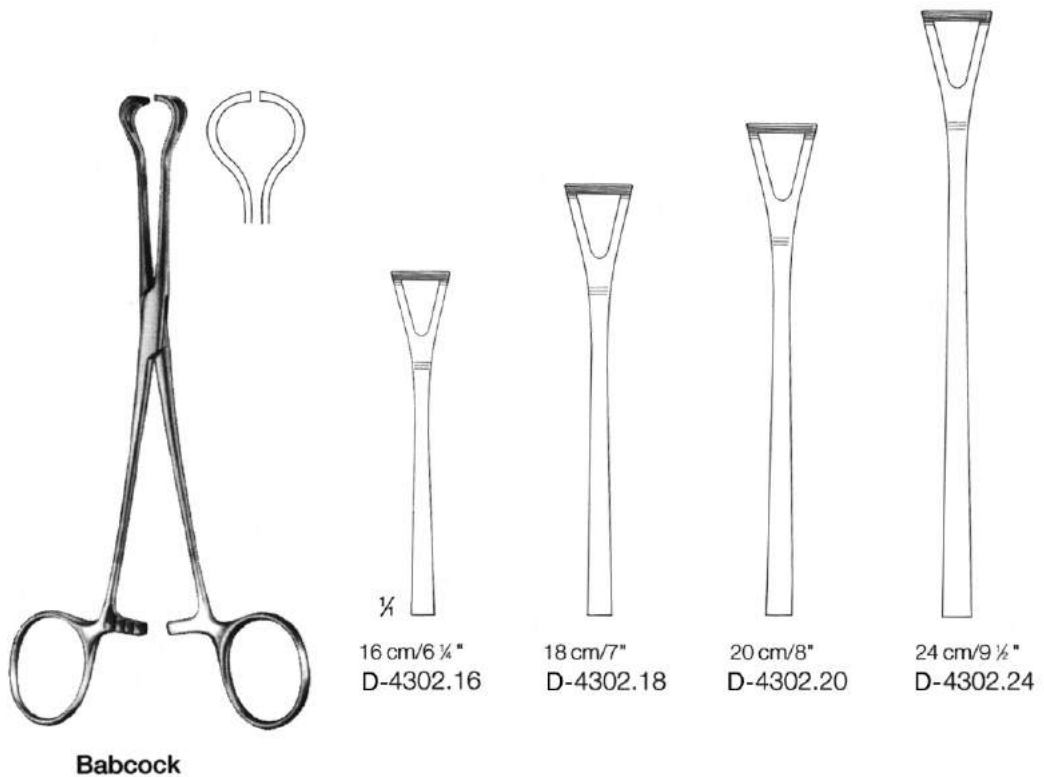
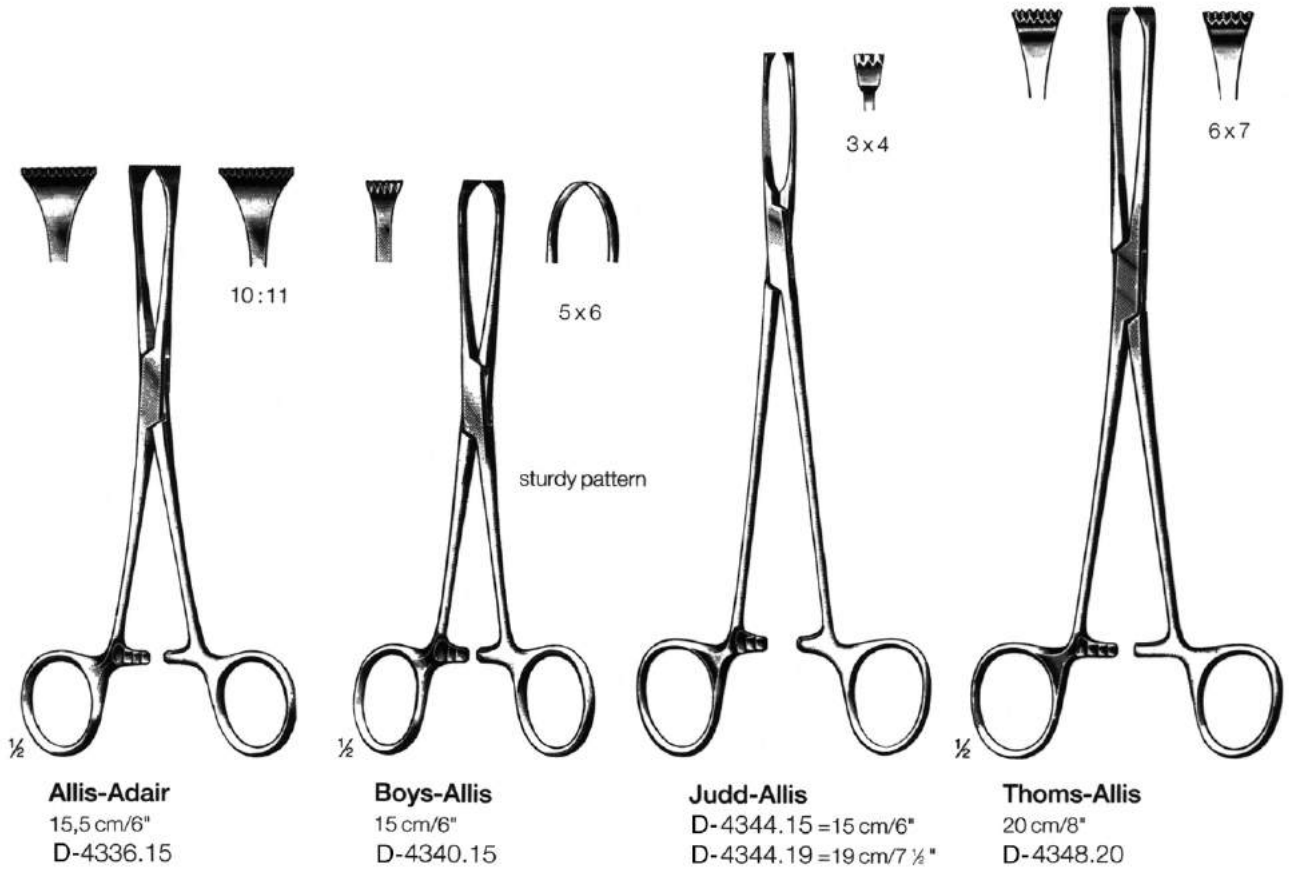

Intestinal Grasping Forceps

Intestinale saisissant le Pinces

Pinza intestinal

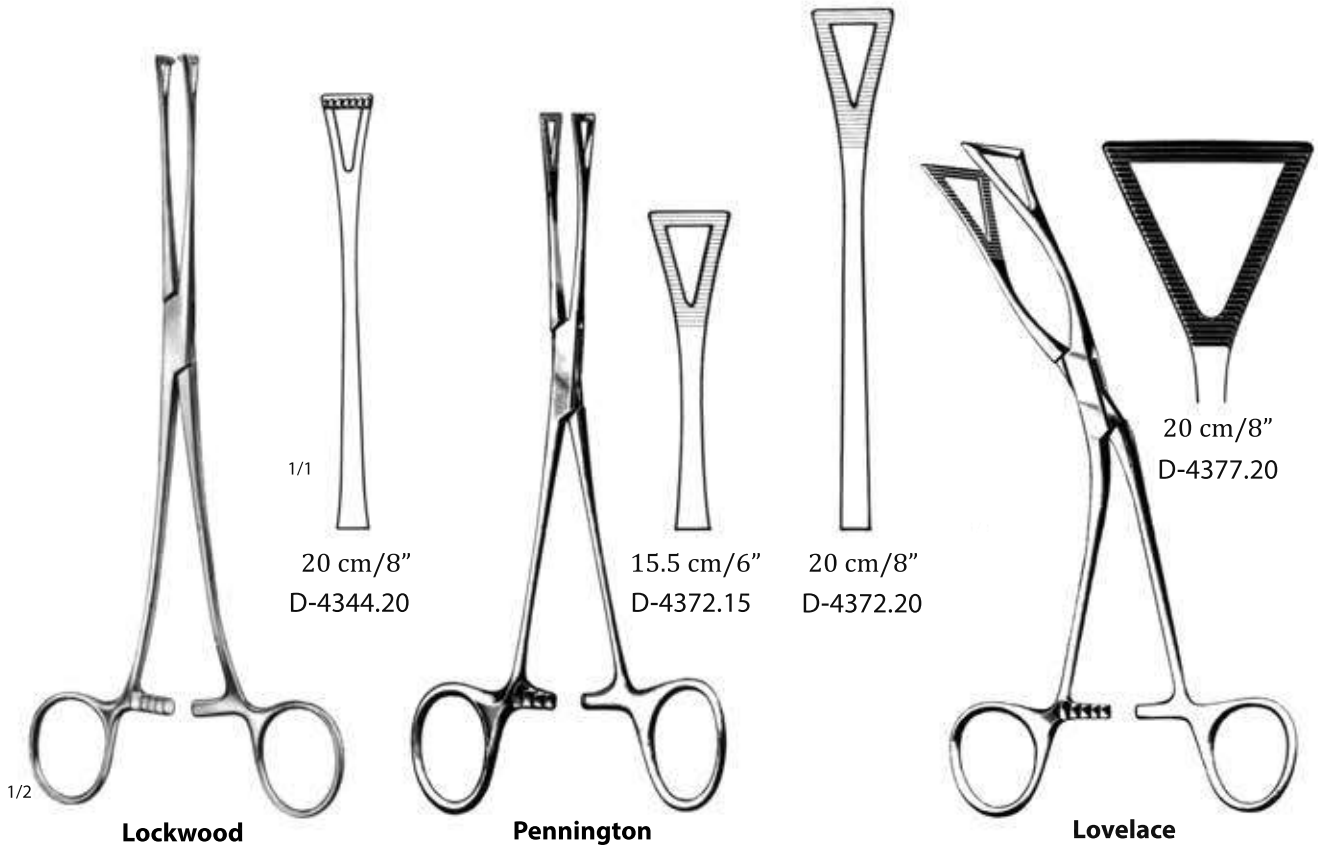
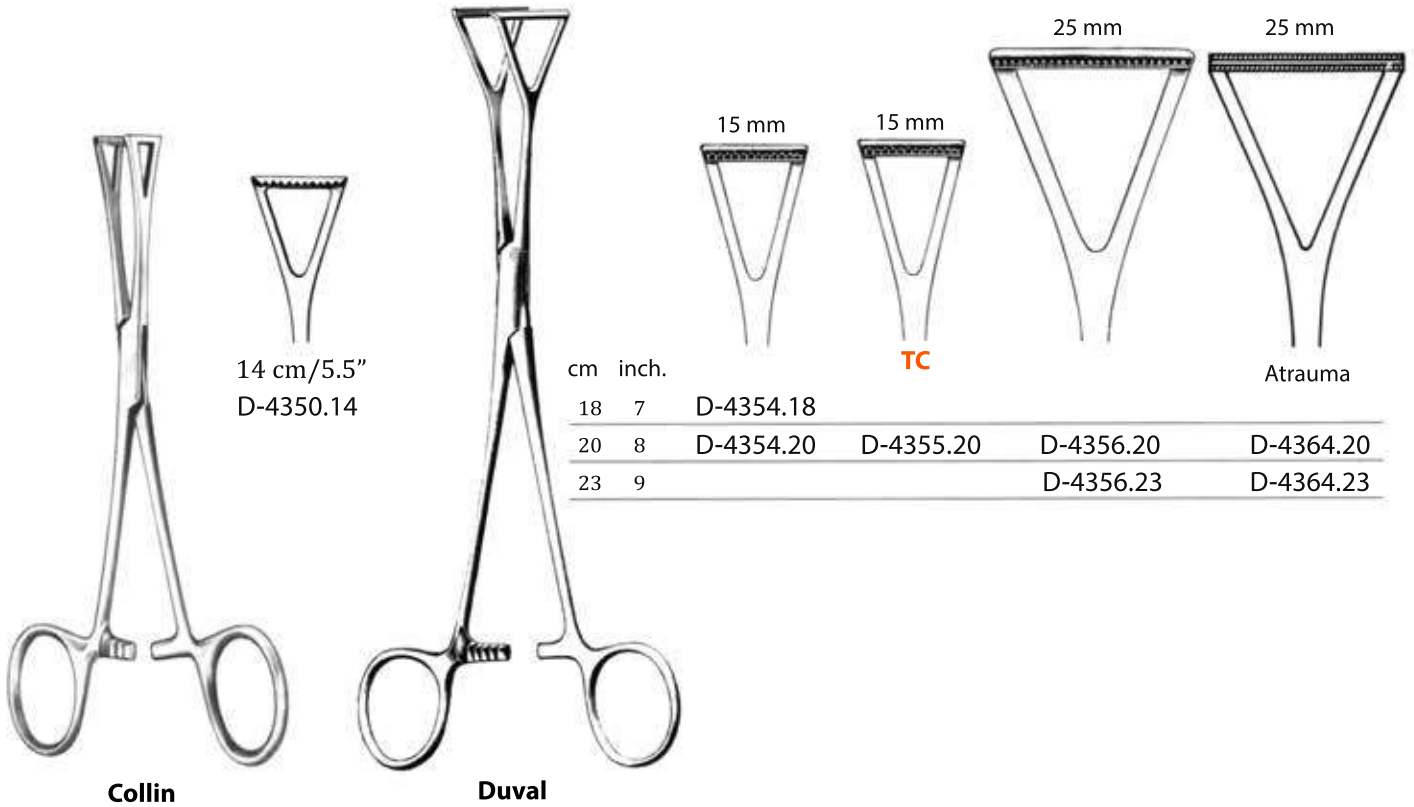



Sigmoid anastomosis forceps
Pinces pour anastomoses du sigmoïde
Pinzas para anastomosis del recto

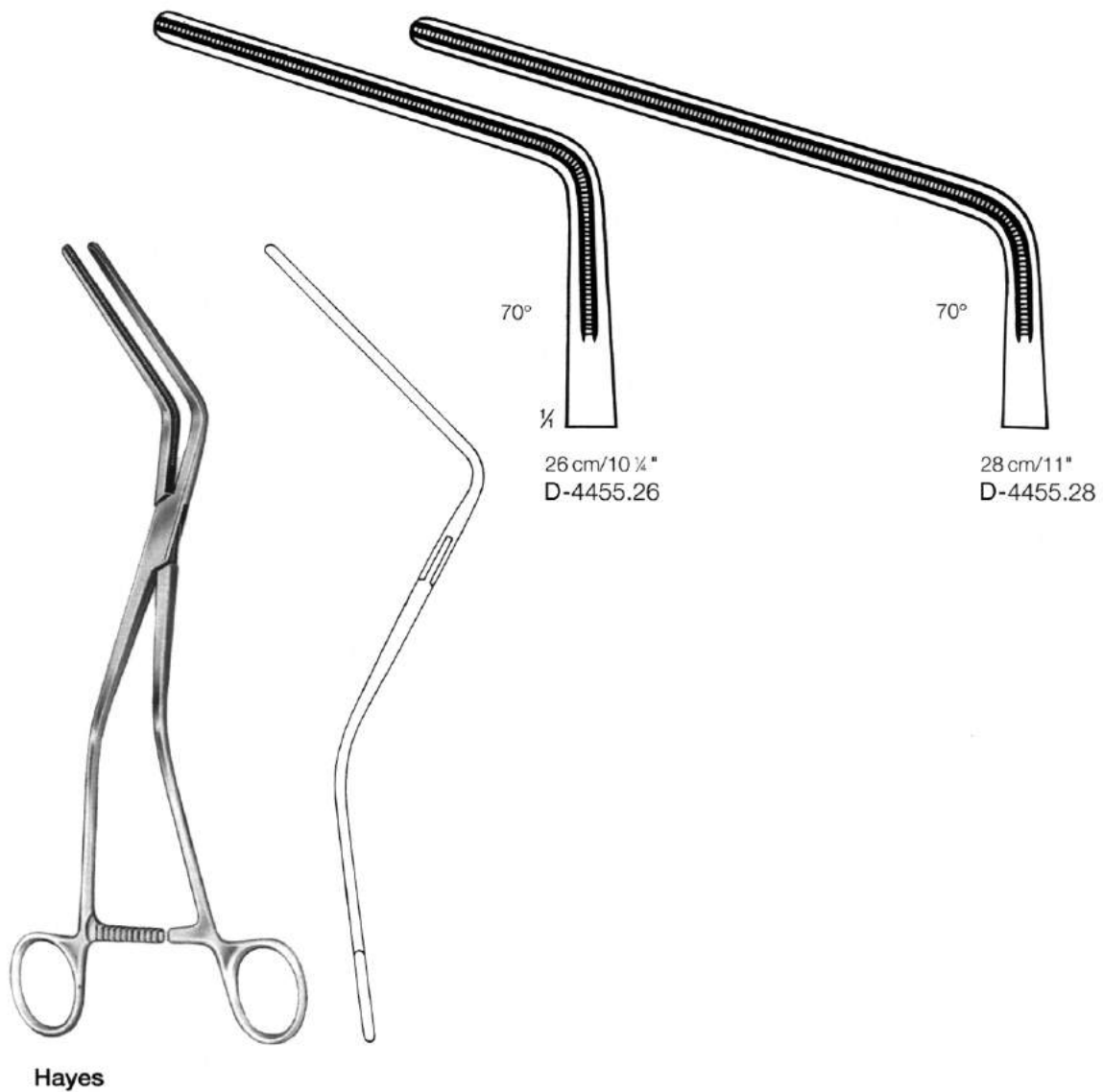

Scalp Flap Forceps

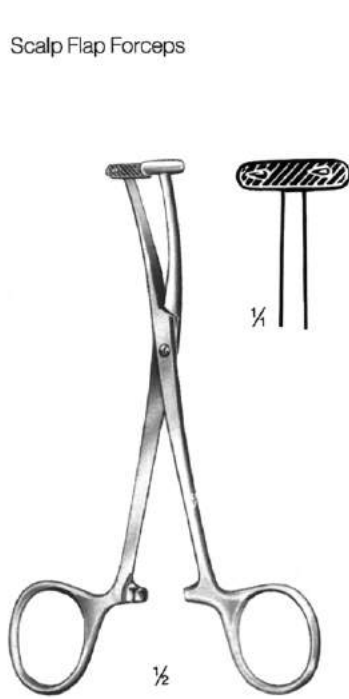

DeMartel
 14 cm/5 1/2"
 D-4501.14



DeMartel (Willett)
 18 cm/7"
 D-4501.18

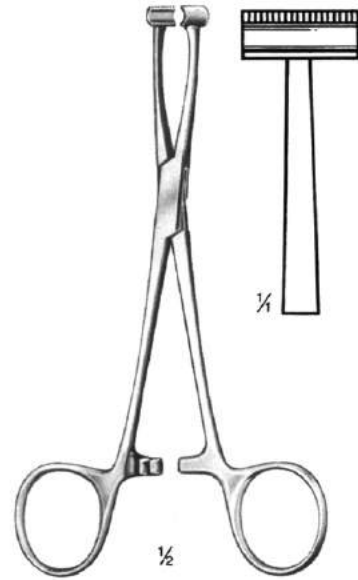

Pratt
 15 cm/6"
 D-4504.15

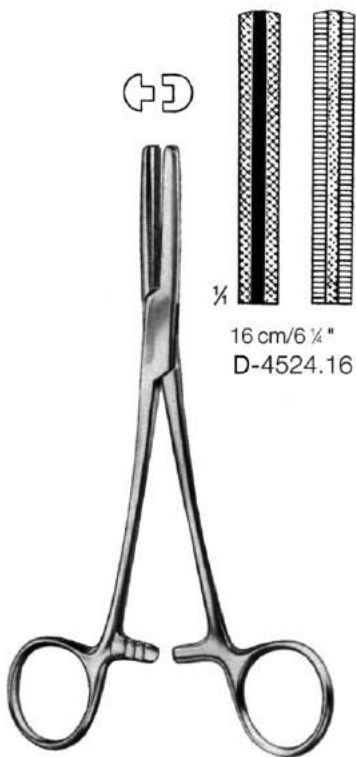

Fergusson

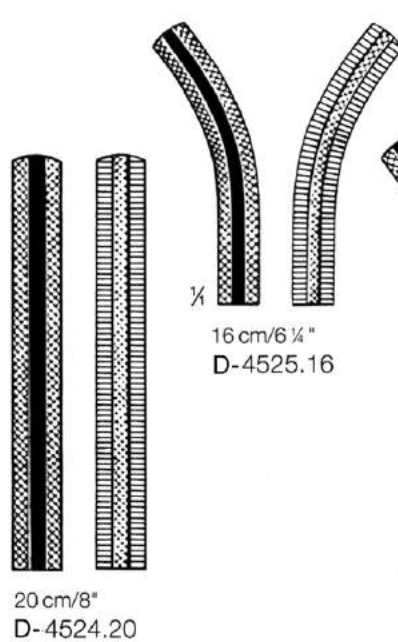

Haemorrhoidal Forceps

16 cm/6 1/4"
 D-4524.16

16 cm/6 1/4"
 D-4525.16

20 cm/8"
 D-4524.20

20 cm/8"
 D-4525.20

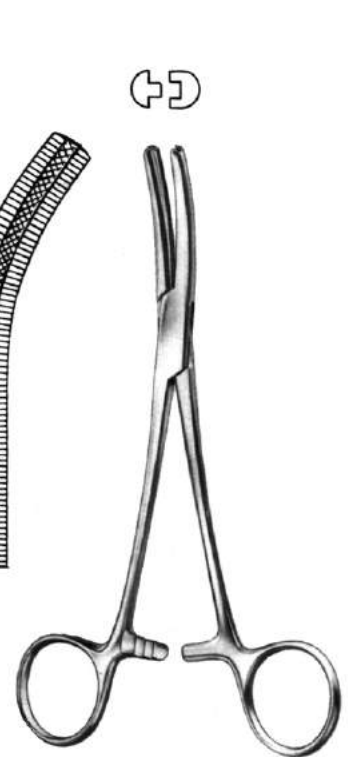

Fergusson

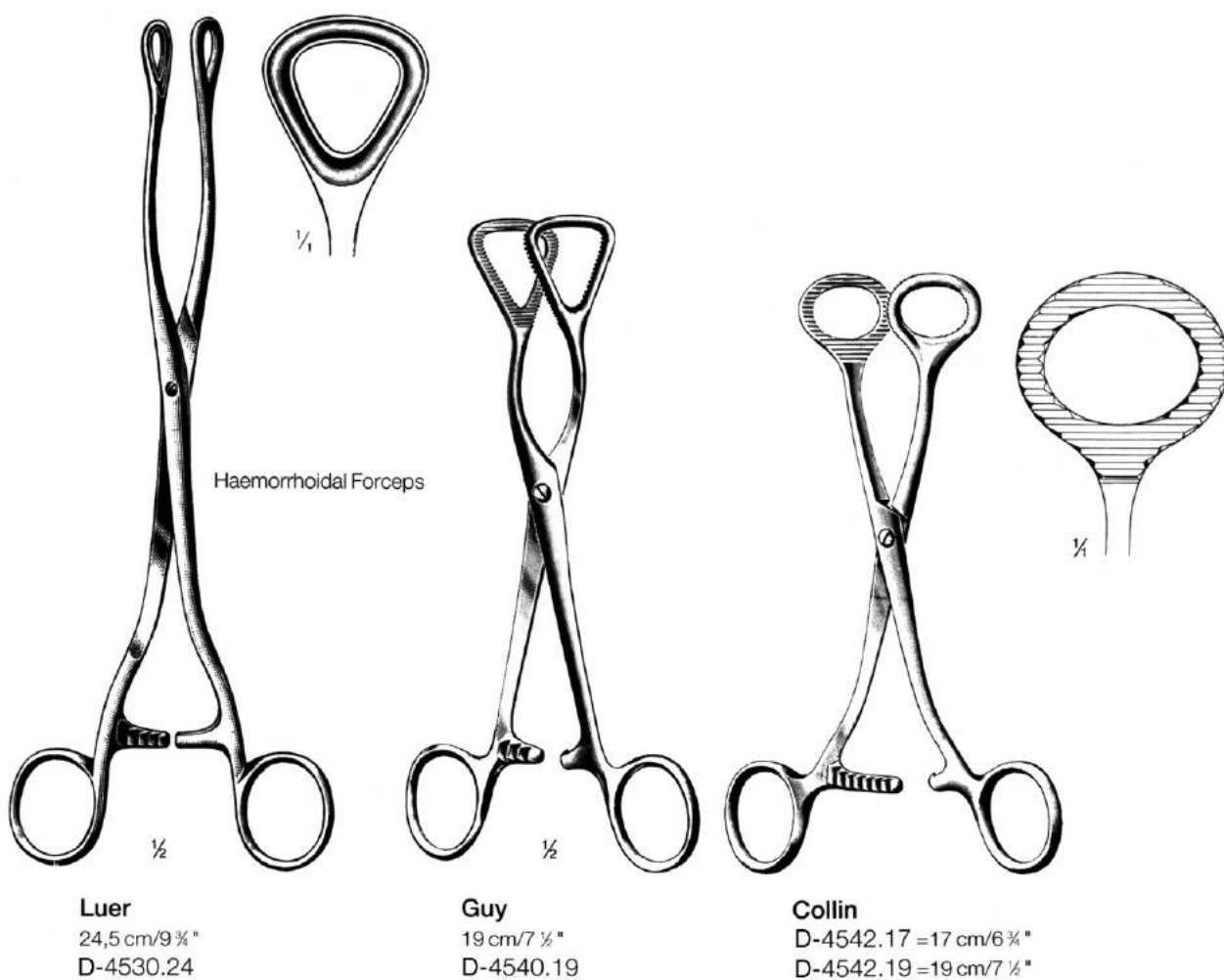

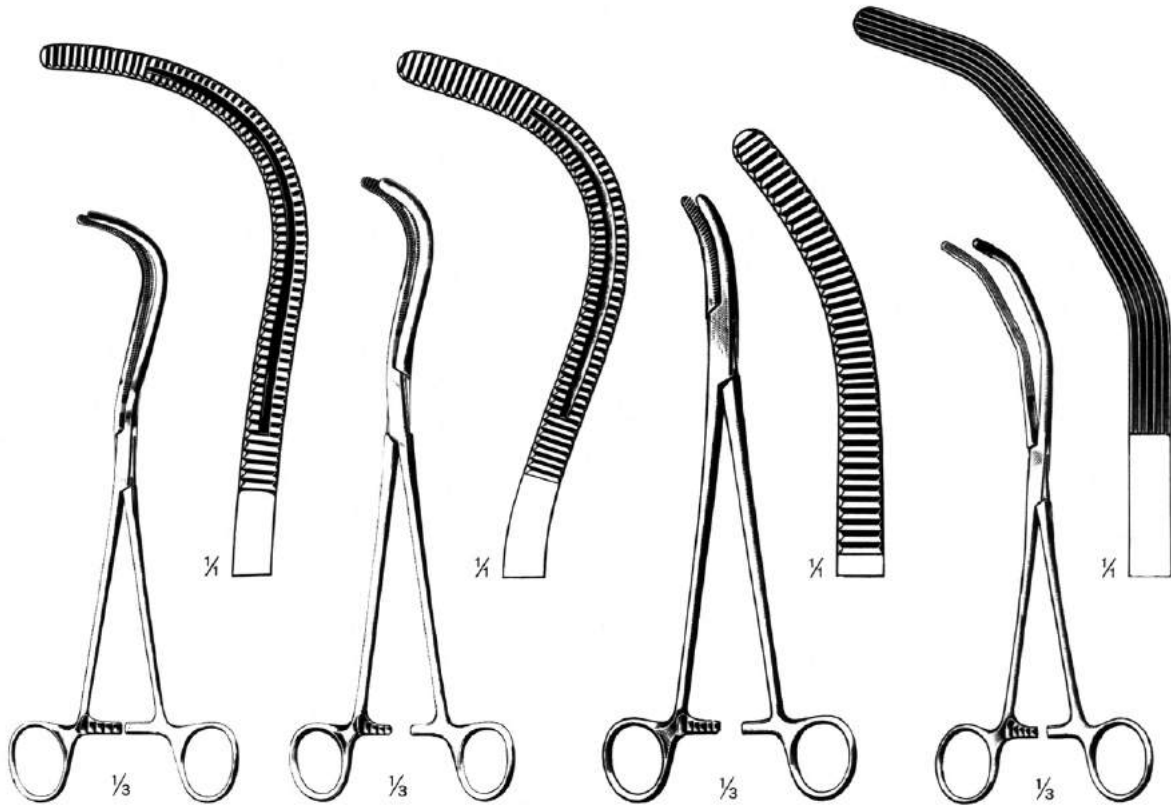

Stille
 22 cm/8 5/8"
 D-4601.22

Stille
 24 cm/9 1/2"
 D-4601.24

Wertheim
 25 cm/10"
 D-4613.25

Herrick
 23 cm/9"
 D-4621.23



Péan



20 cm/8"
 D-4623.20



22 cm/8 5/8"
 D-4623.22

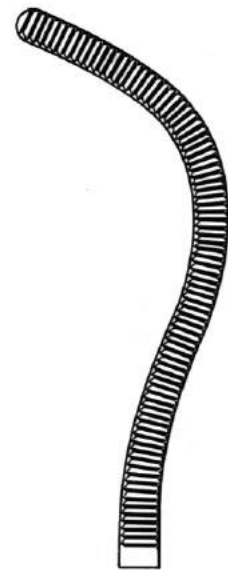

24 cm/9 1/2"
 D-4623.24

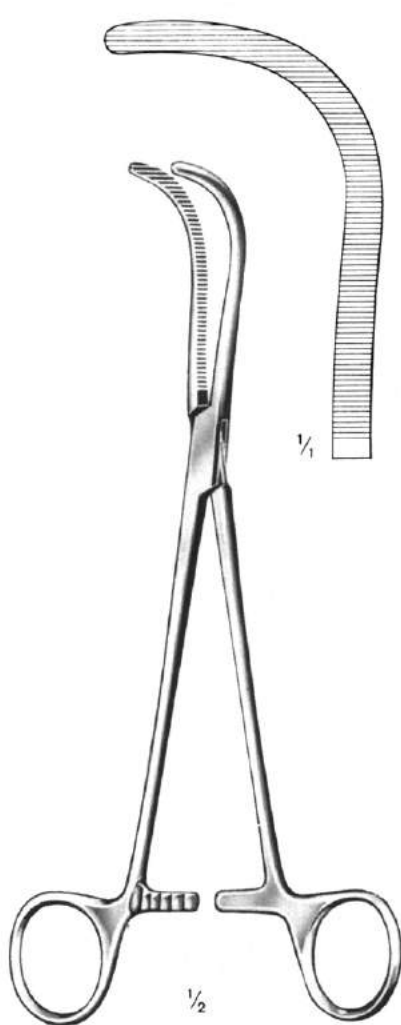

Guyon
23 cm/9"
D-4625.23

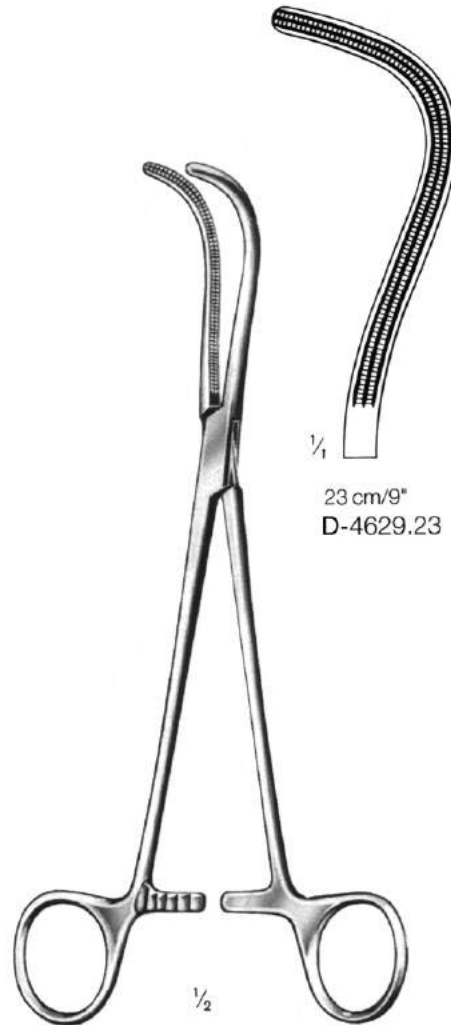

23 cm/9"
D-4629.23

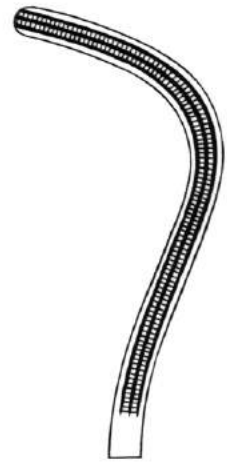

24 cm/9 1/2"
D-4629.24

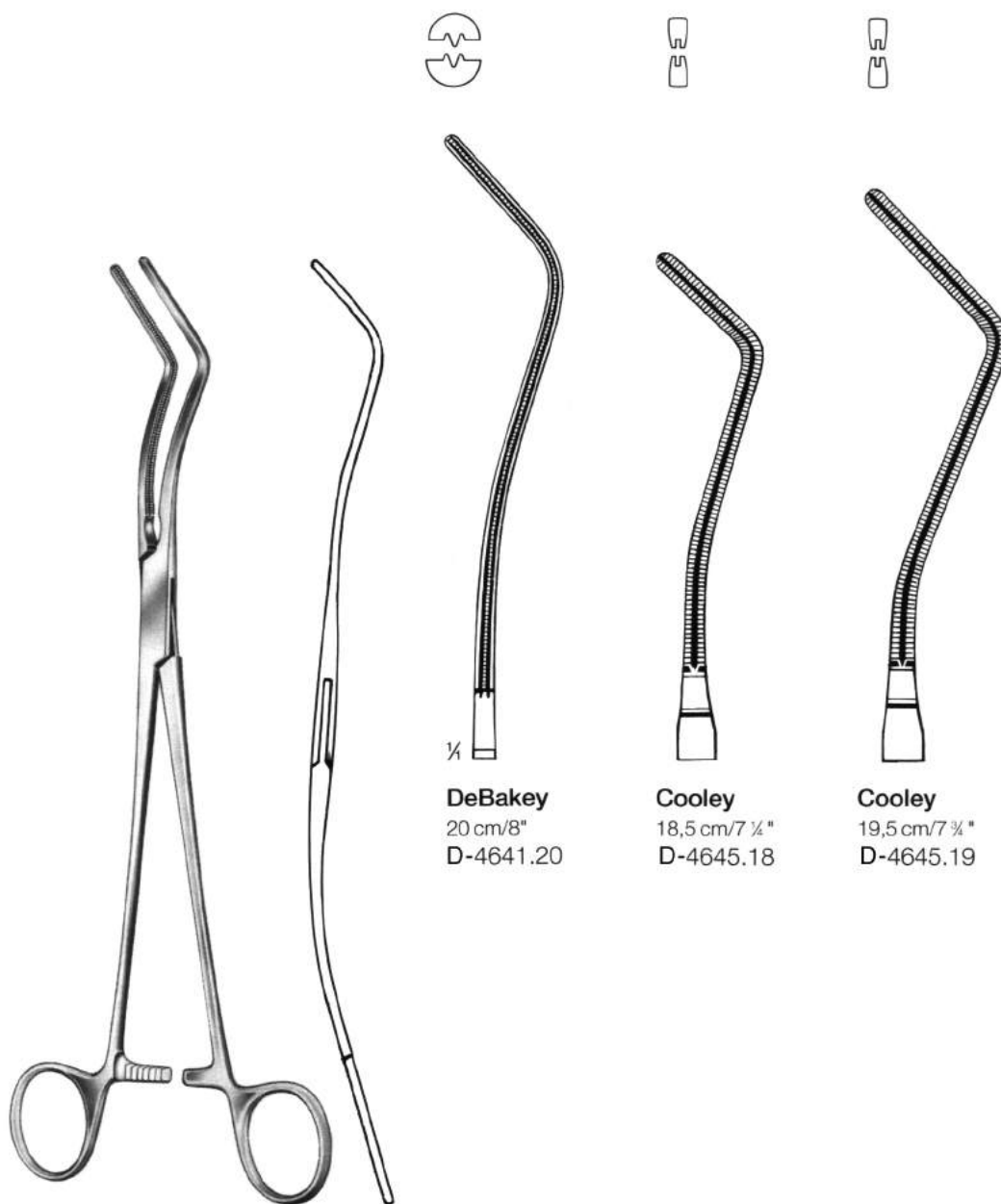

DeBakey
20 cm/8"
D-4641.20

Cooley
18,5 cm/7 1/4"
D-4645.18

Cooley
19,5 cm/7 3/4"
D-4645.19

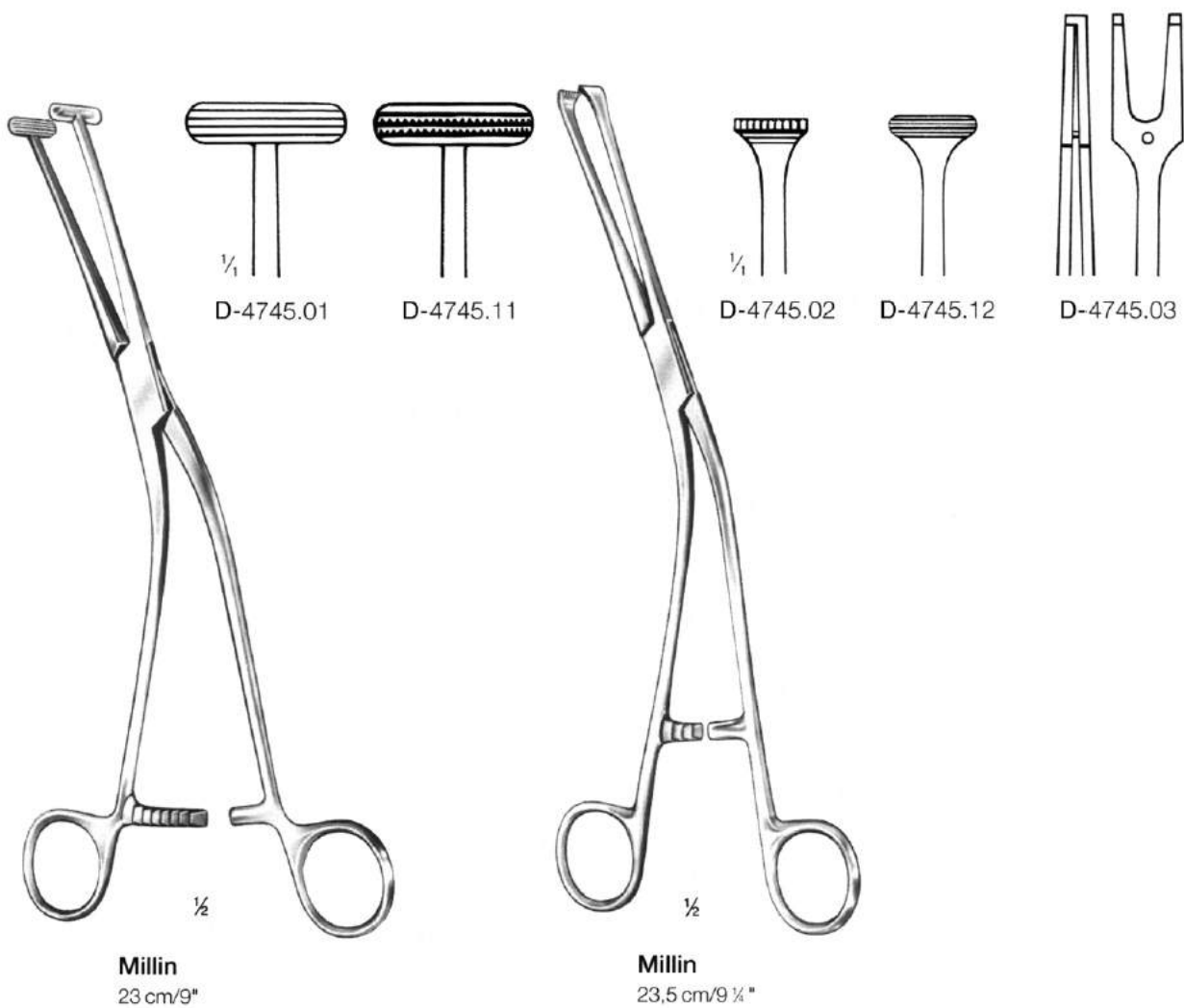

Kidney stone forceps
Pinces pour les calculs rénaux
Pinzas para cálculos renales

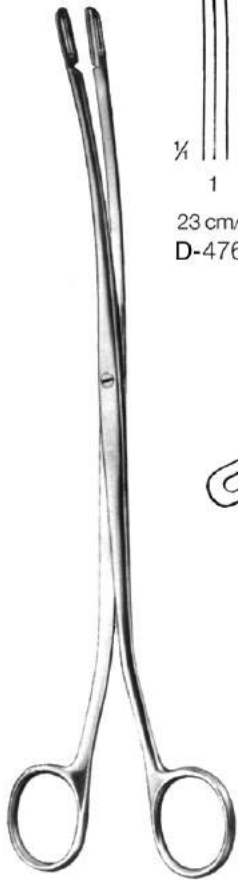
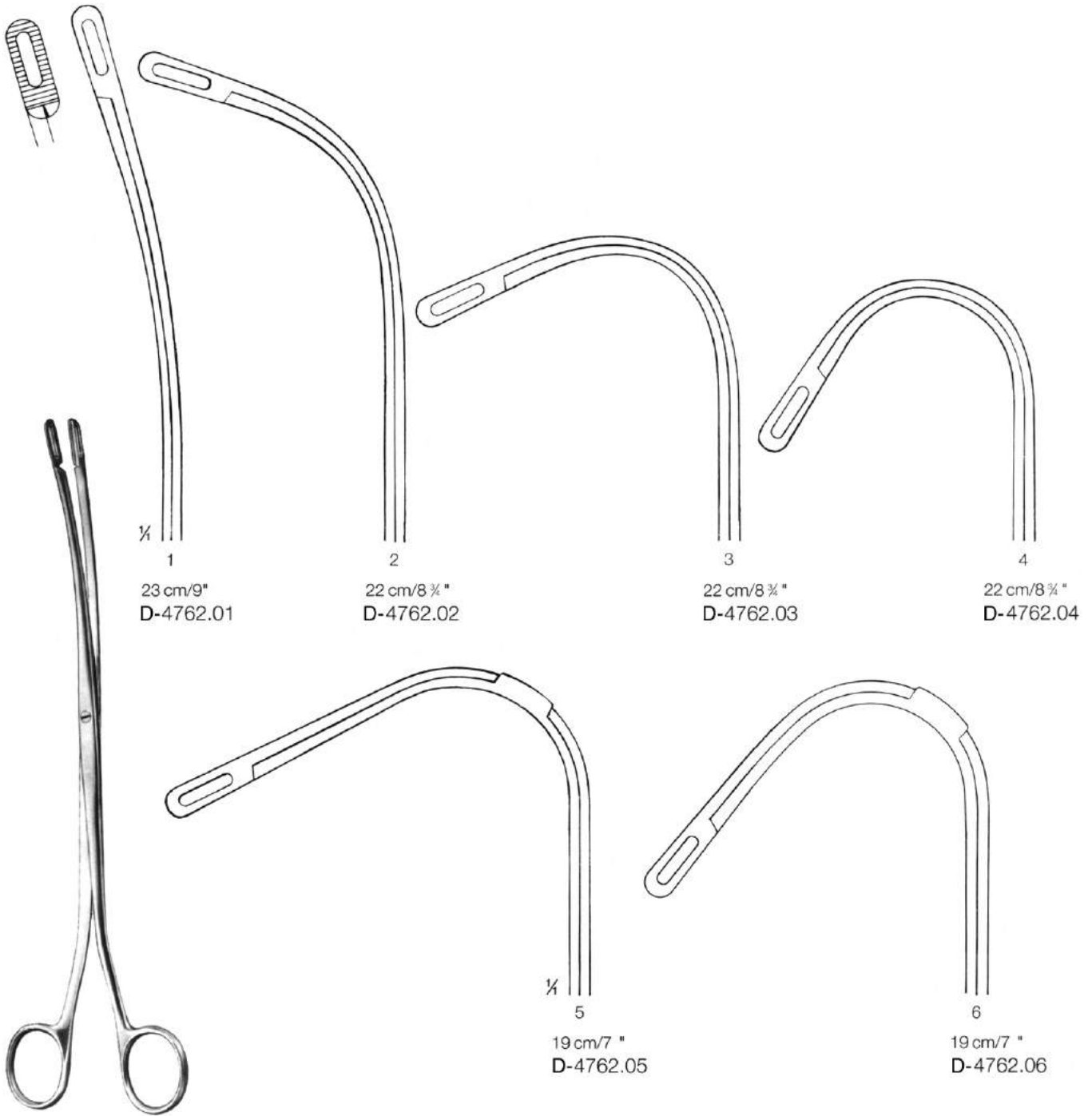

Randall

Gall Duct- and cystic forceps
Pinces-clamps pour voies biliaires et cystiques
Pinzas-clamps para conductos biliares y pinzas cisticas

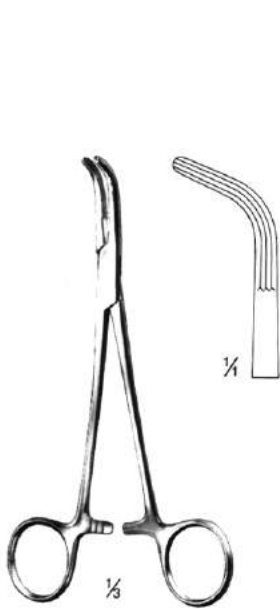

Lower
 18 cm/7"
 D-4825.18

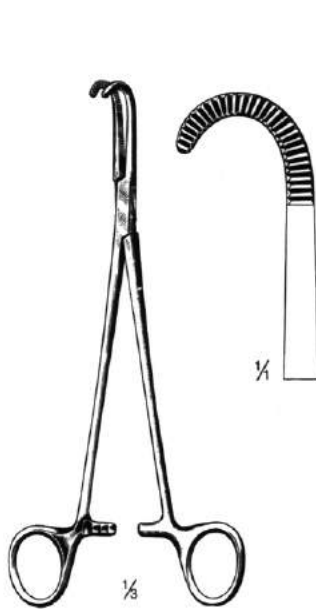

Desjardins
 21 cm/8 1/4"
 D-4837.21



Nissen
 22,5 cm/9"
 D-4839.22

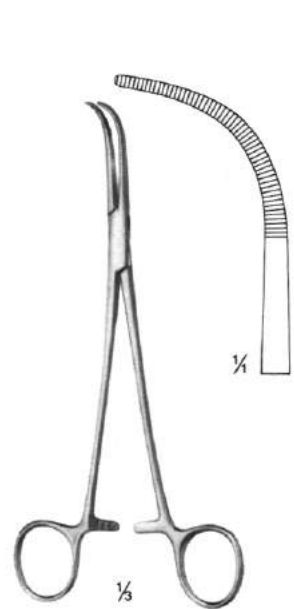

Green
 20 cm/8"
 D-4843.20



Gray

22 cm/8 3/4"
 D-4853.22

23 cm/9"
 D-4853.23



Moynihan

23 cm/9"
 D-4865.23

24 cm/9 1/2"
 D-4865.24

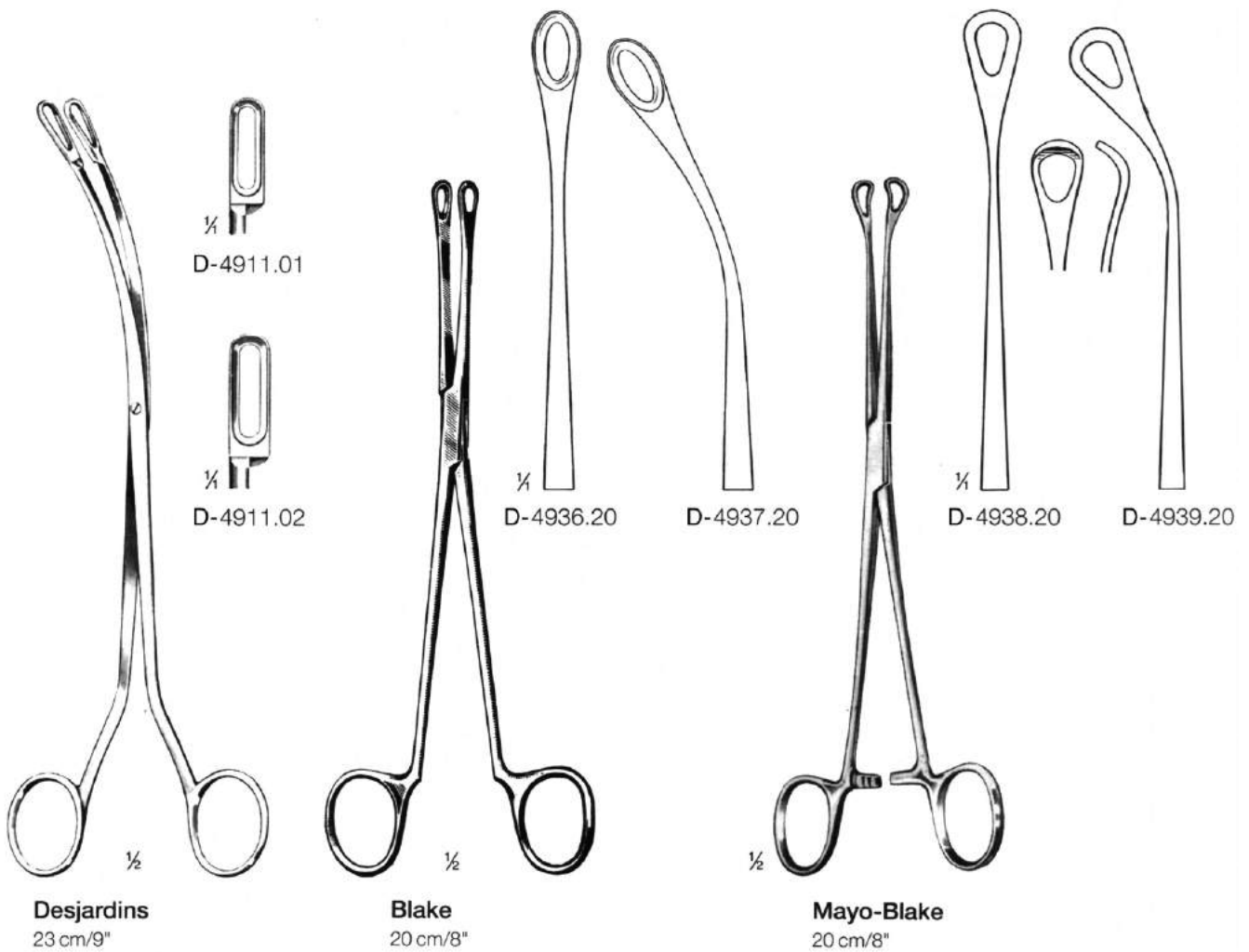

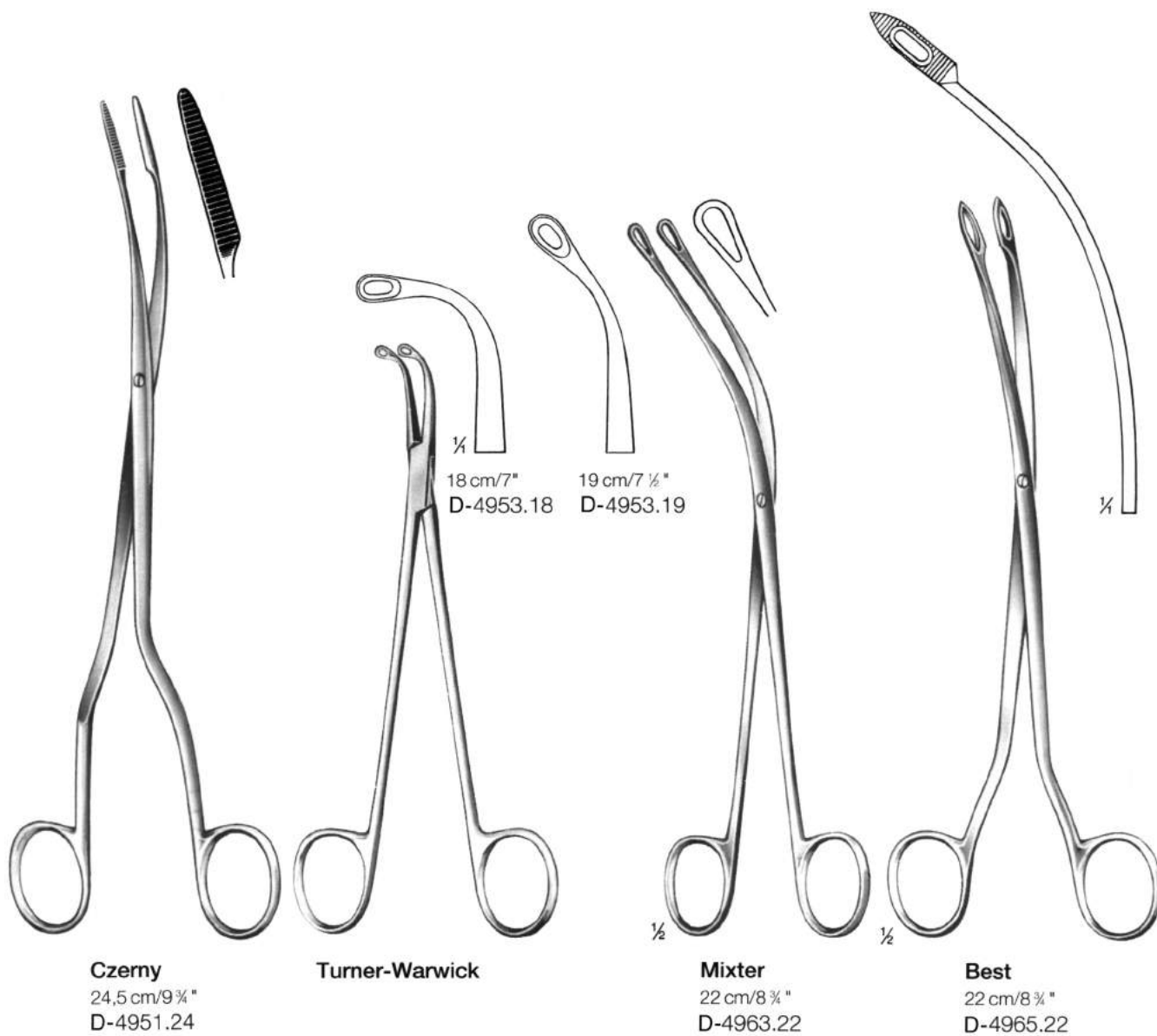

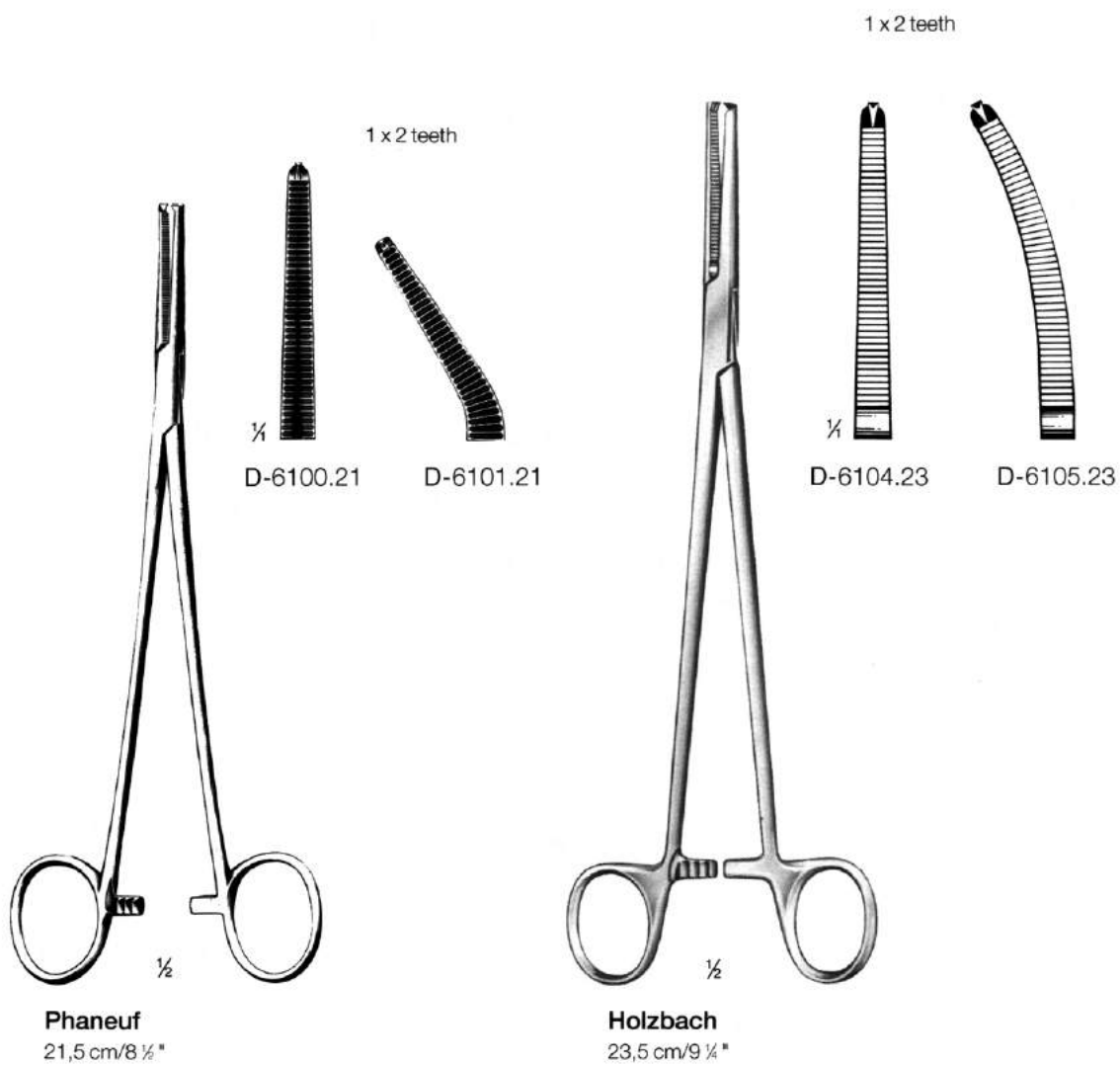

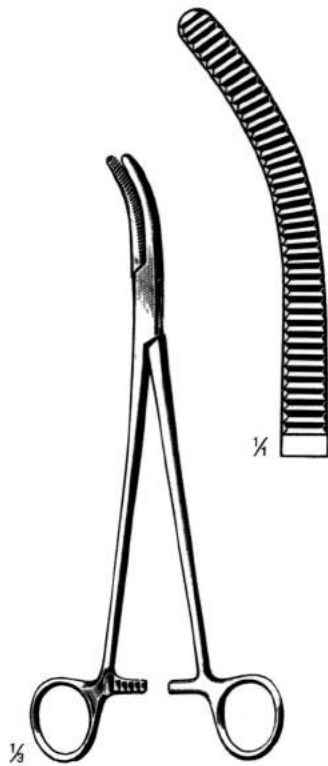

Wertheim
 25 cm/10"
 D-4613.25

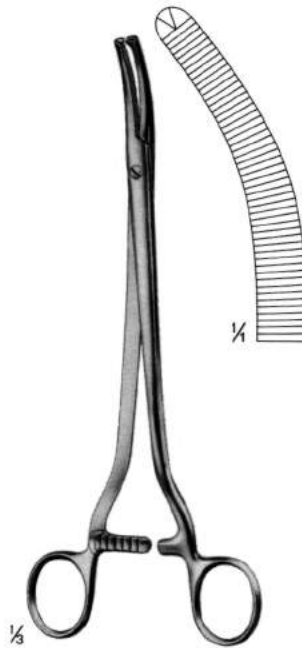

Wertheim
 24 cm/9 1/2"
 D-6125.24

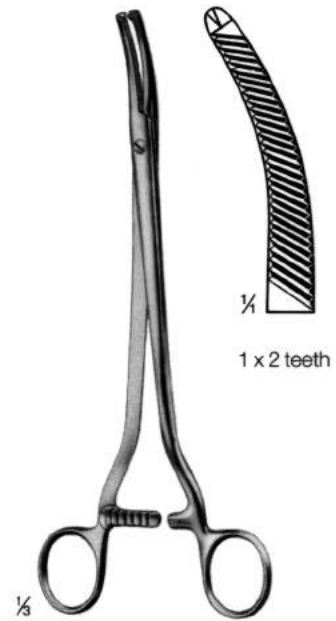

Wertheim
 23 cm/9"
 D-6129.23

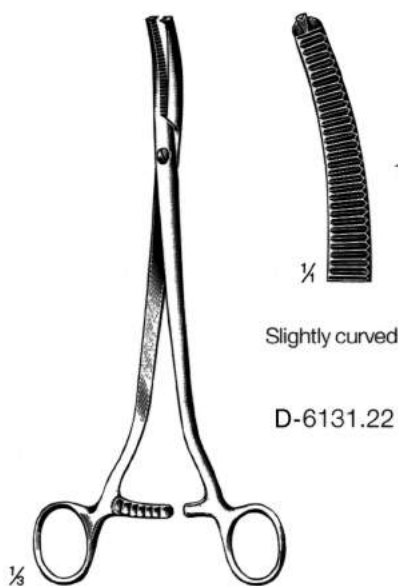

Wertheim
 23 cm/9"

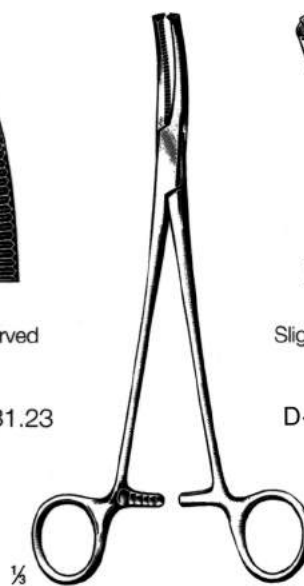
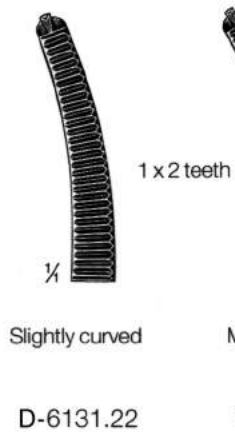

Wertheim
 23 cm/9"

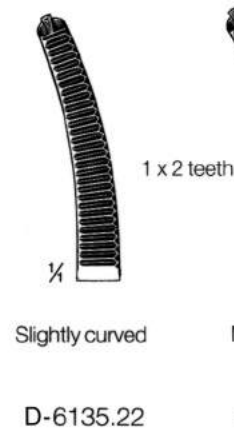



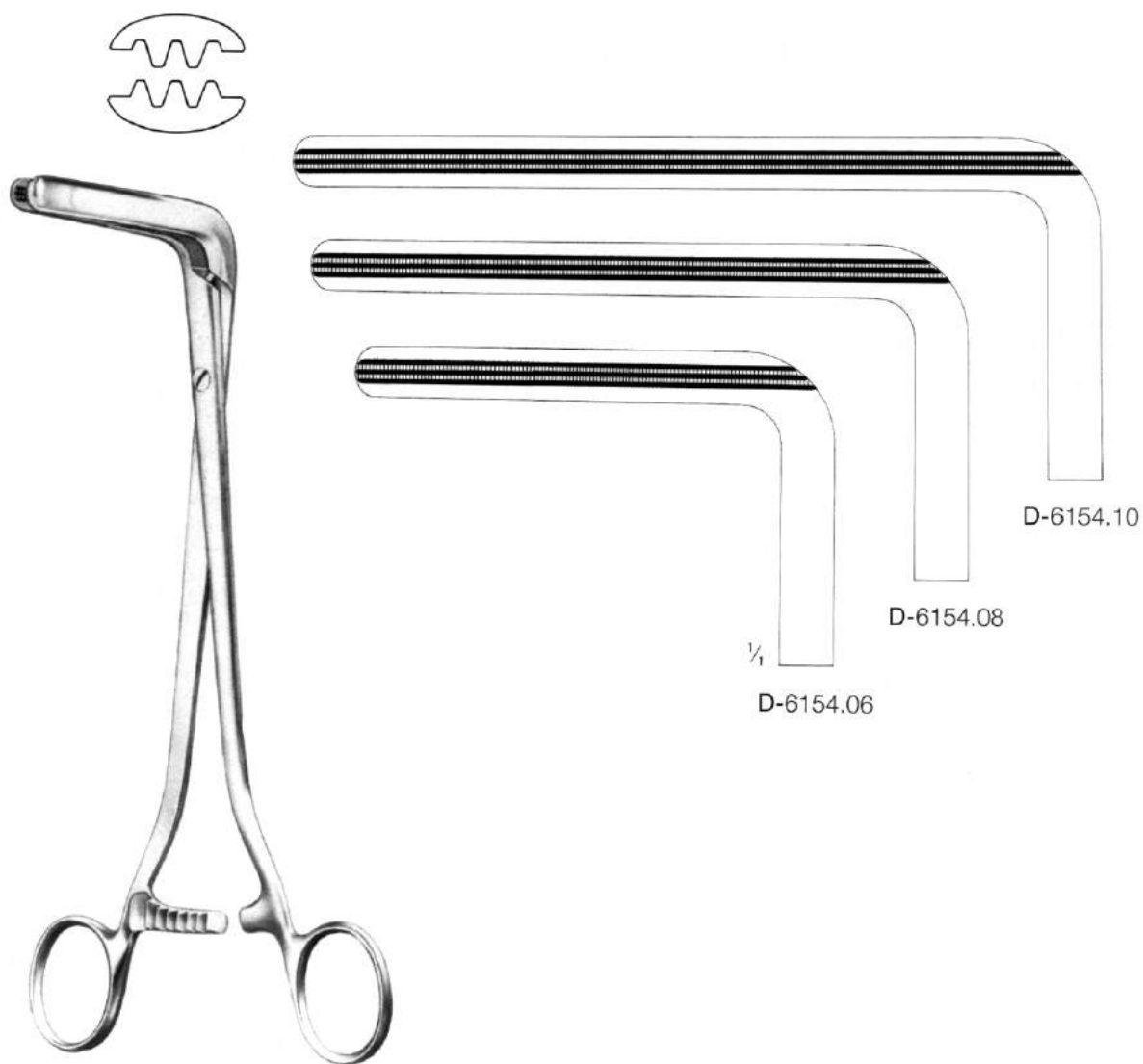

Wertheim
24 cm/9 1/2 "

Peritoneal clamp forceps
Pinces-clamps pour le péritoine
Pinzas-clamps para peritoneo

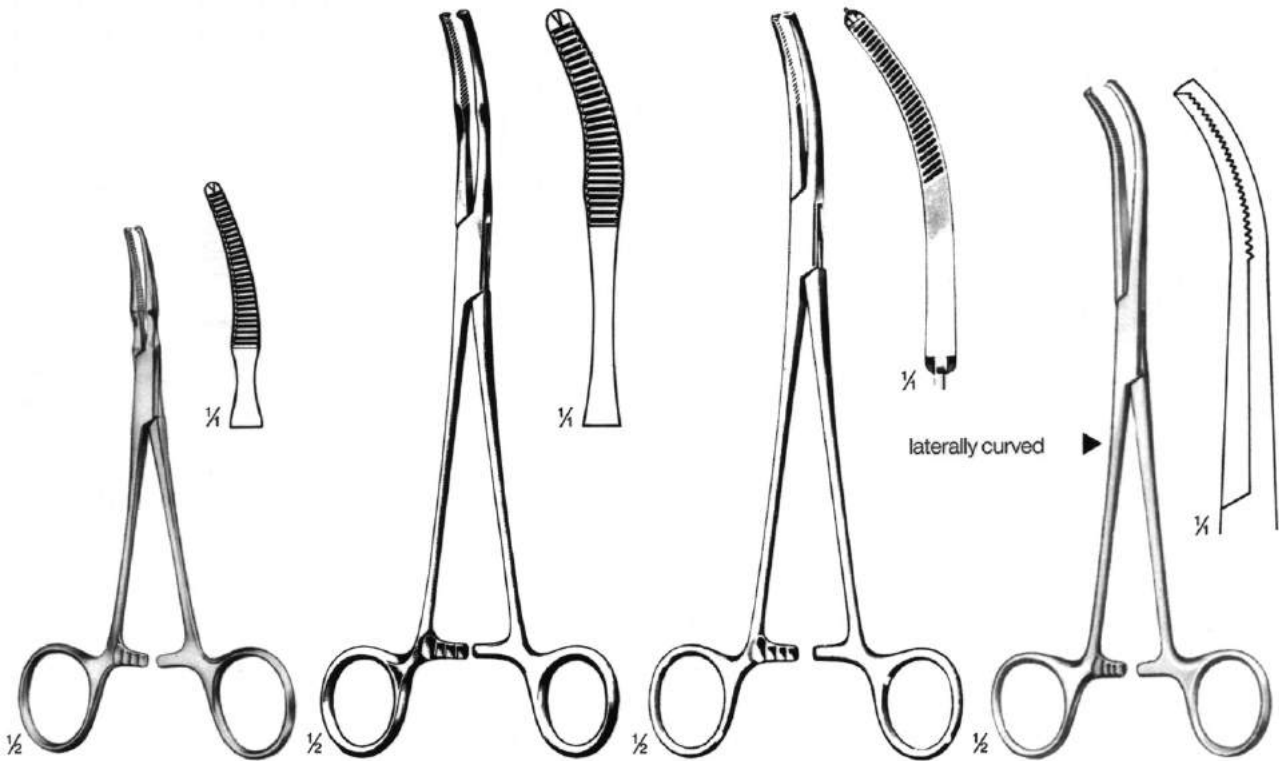

Baby-Mikulicz
 14 cm/5 1/2"
 D-6201.14

Miculicz
 20 cm/8"
 D-6201.20

Miculicz
 20 cm/8"
 D-6207.20

Miculicz
 18,5 cm/7 1/4"
 D-6209.18

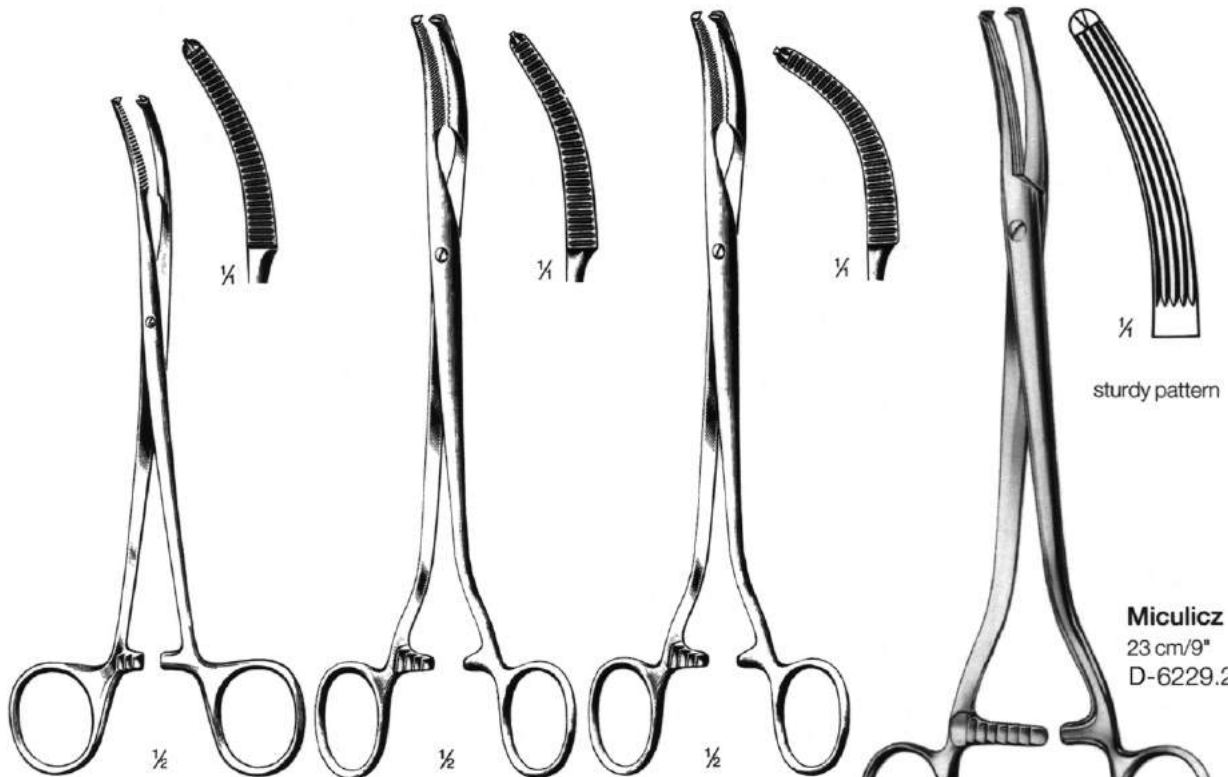

Miculicz
 18 cm/7"
 D-6221.18

Miculicz
 20 cm/8"
 D-6223.20

Miculicz
 20 cm/8"
 D-6225.20

Miculicz
 23 cm/9"
 D-6229.23

Peritoneal Clamp Forceps



Schindler
19 cm/7 1/2"
D-6241.19

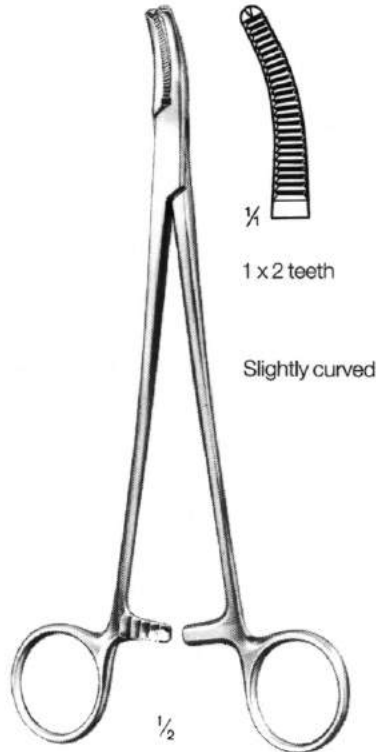

Faure
20 cm/8"
D-6243.20

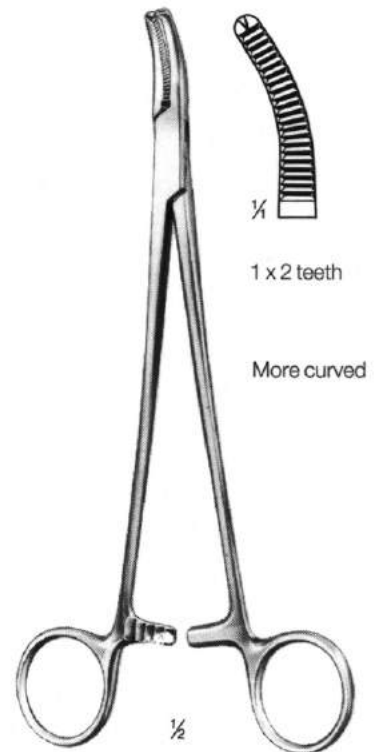

Faure
20 cm/8"
D-6245.20

Hysterectomy Forceps

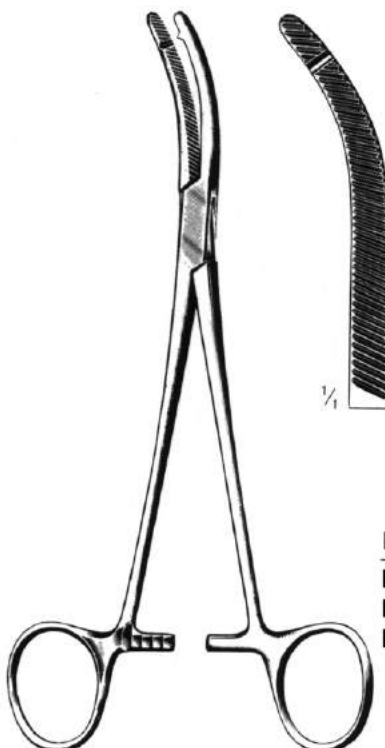

Heaney	cm	inch.	Heaney
D-6321.21	21	8 1/4	D-6323.21
D-6321.23	23	9	D-6323.23
D-6321.25	25	10	D-6323.25

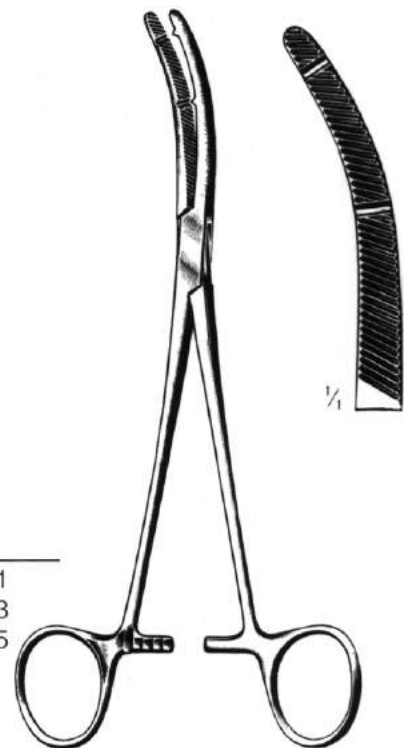

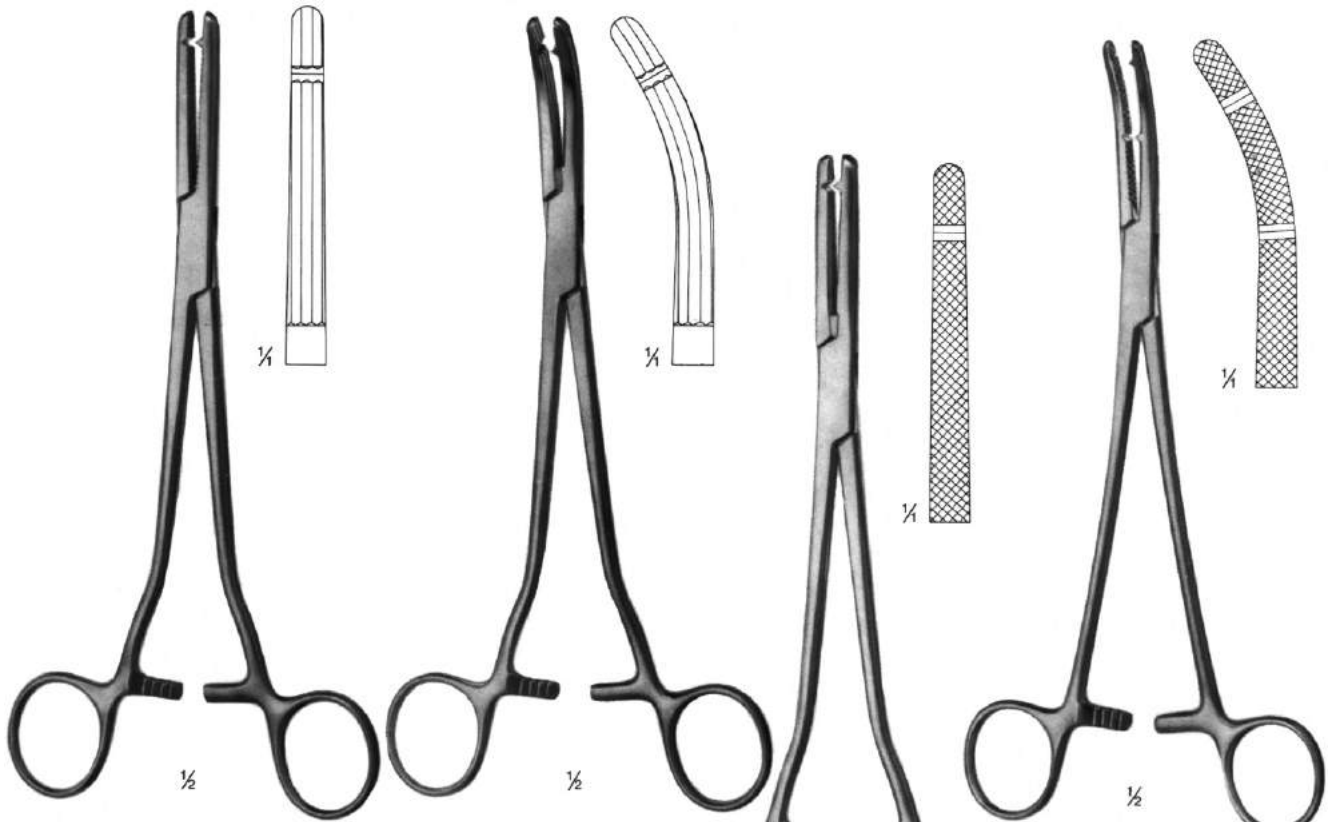

Ballentine
21,5 cm/8 1/2"
D-6330.21

Heaney-Ballentine
21,5 cm/8 1/2"
D-6331.21

Heaney-Rezek
21,5 cm/8 1/2"
D-6338.21

Heaney-Kanter
21,5 cm/8 1/2"
D-6341.21

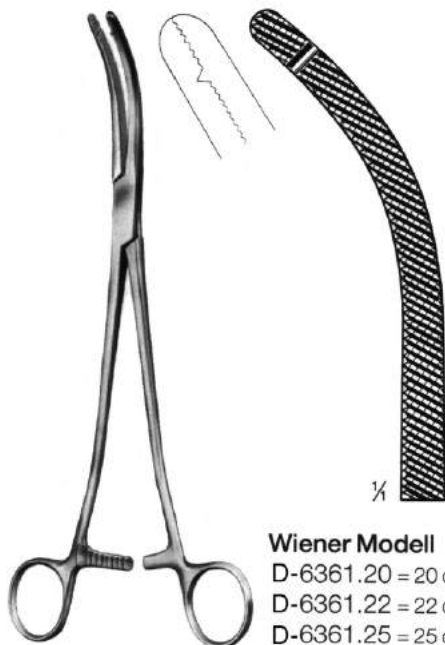

Wiener Modell
D-6361.20 = 20 cm/8"
D-6361.22 = 22 cm/8 1/2"
D-6361.25 = 25 cm/10"

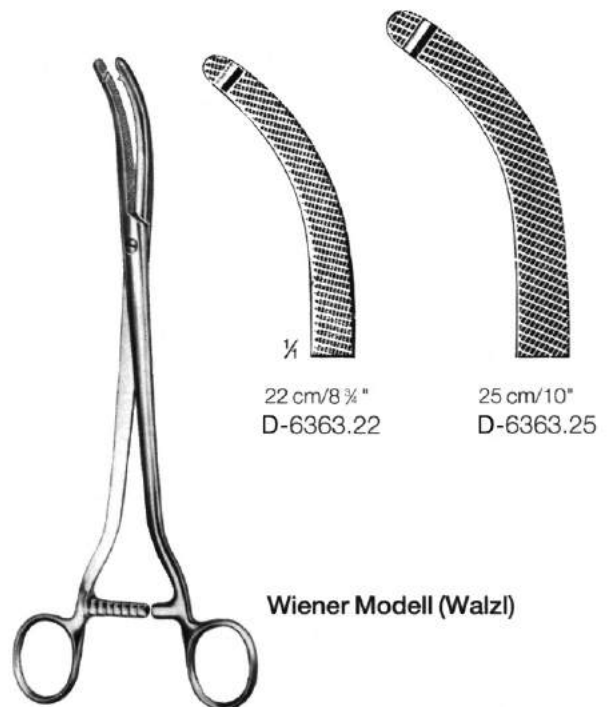

22 cm/8 1/2"
D-6363.22

25 cm/10"
D-6363.25

Wiener Modell (Walzl)

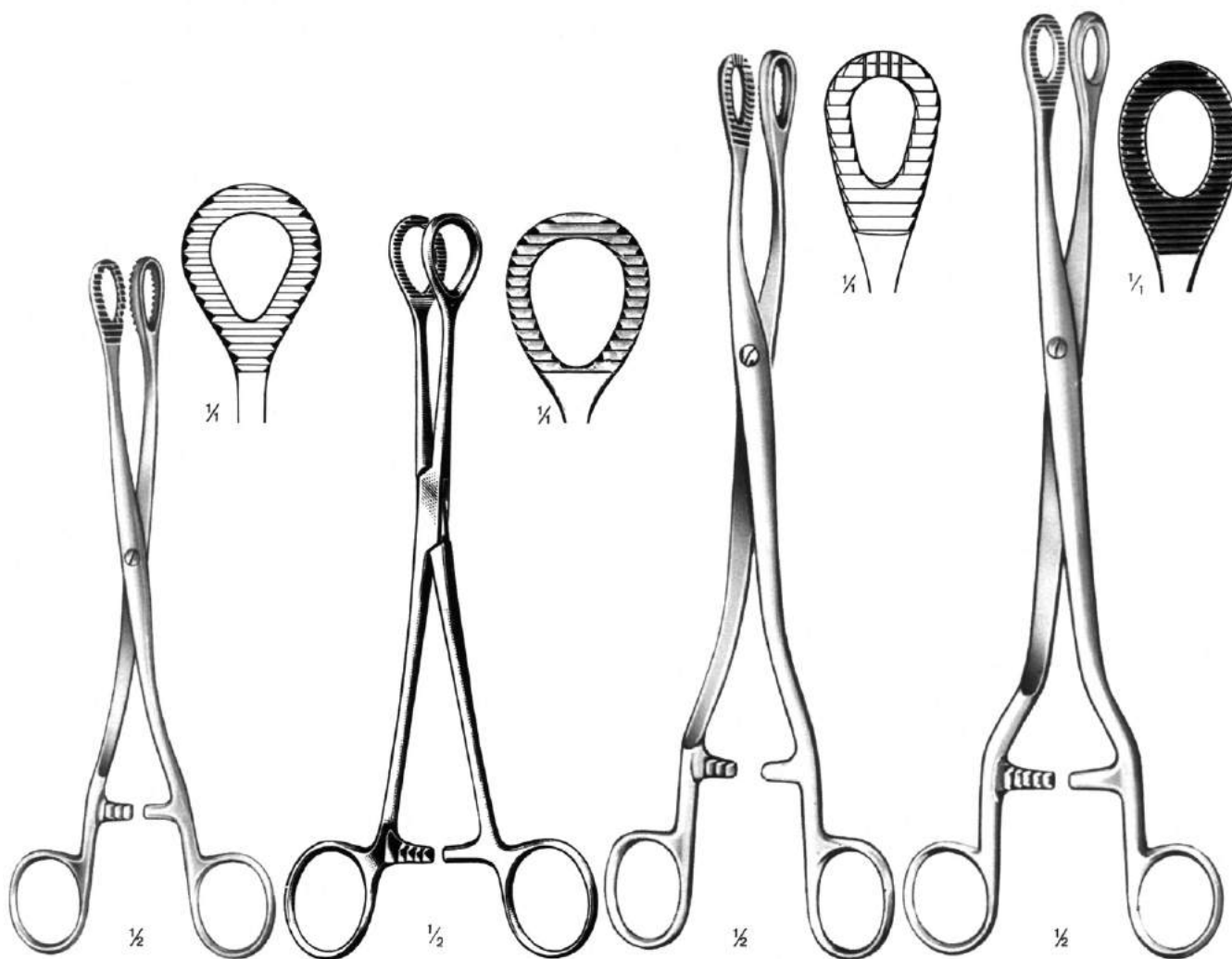

Heywood-Smith
 20 cm/8"
 D-6410.20

Heywood-Smith
 21 cm/8 1/4"
 D-6412.21

Heywood-Smith
 25 cm/10"
 D-6414.25

Noto
 27 cm/10 1/2"
 D-6420.27

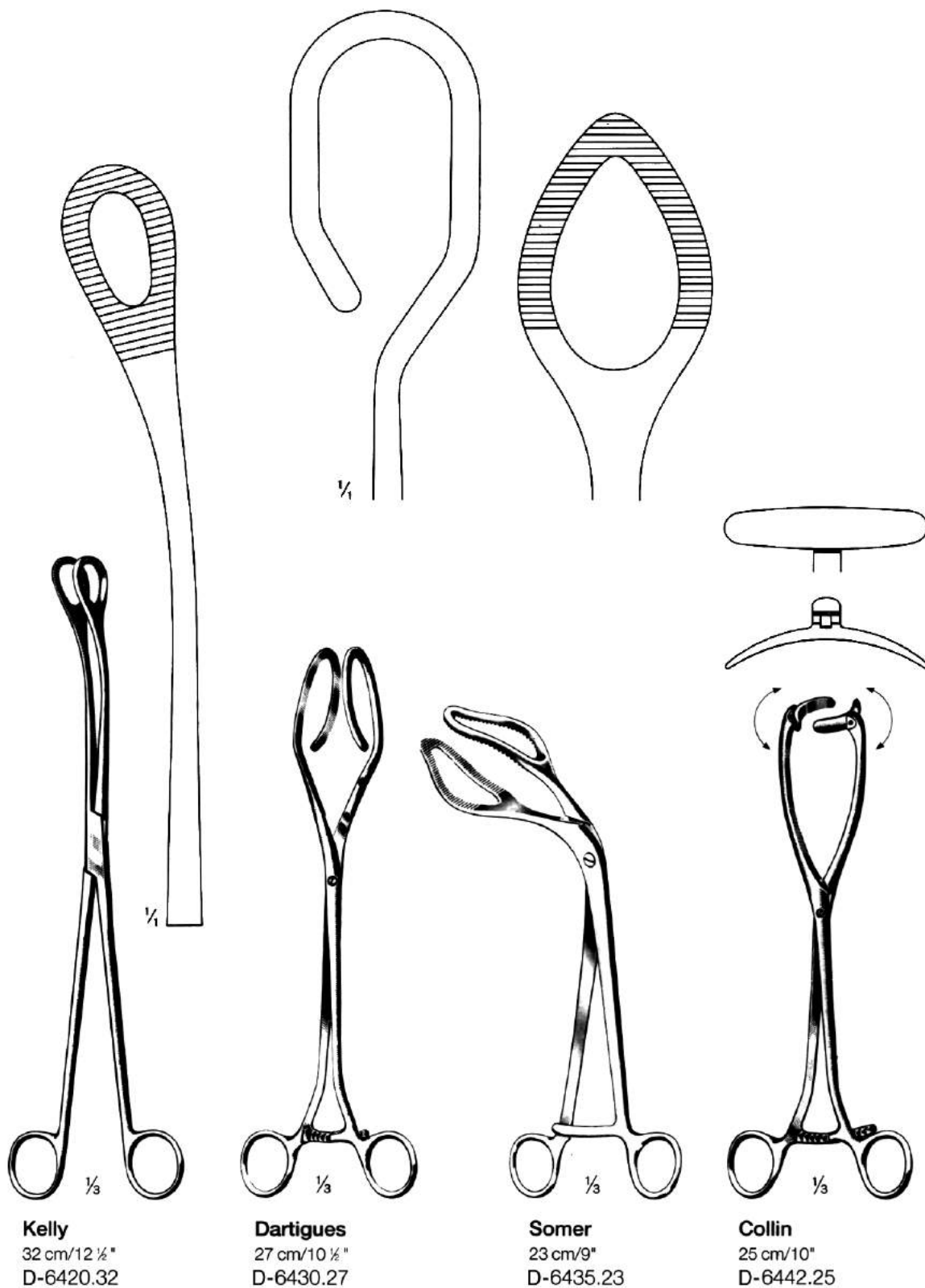



Saenger
27 cm/10 1/2"

Placenta and Ovum Forceps

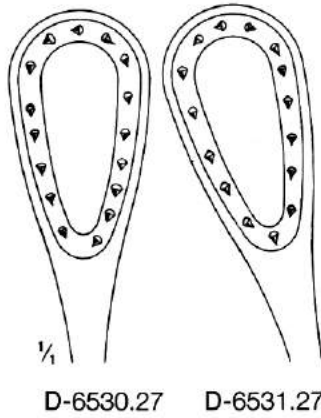

Winter
28 cm/11"

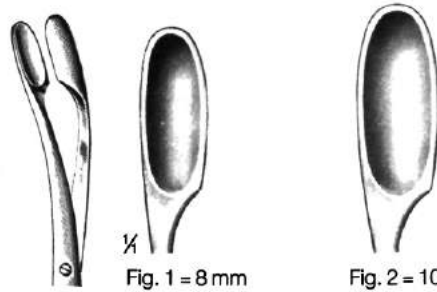

straight	Fig.	curved on flat
D-6540.08	1	D-6541.08
D-6540.10	2	D-6541.10



De Martel (Willett)
18 cm/7"
D-4501.18

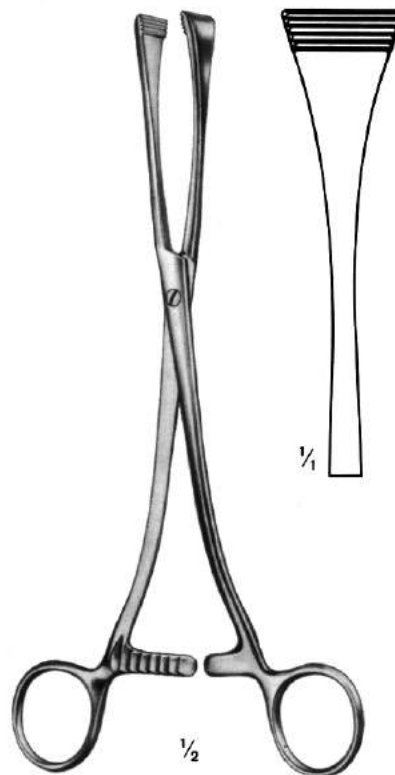

Green-Armytage
21 cm/8 1/4"
D-6750.21

Tenaculum forceps
Pinces pour abaissement du col de l'utérus
Pinzas para coger el cuello del útero

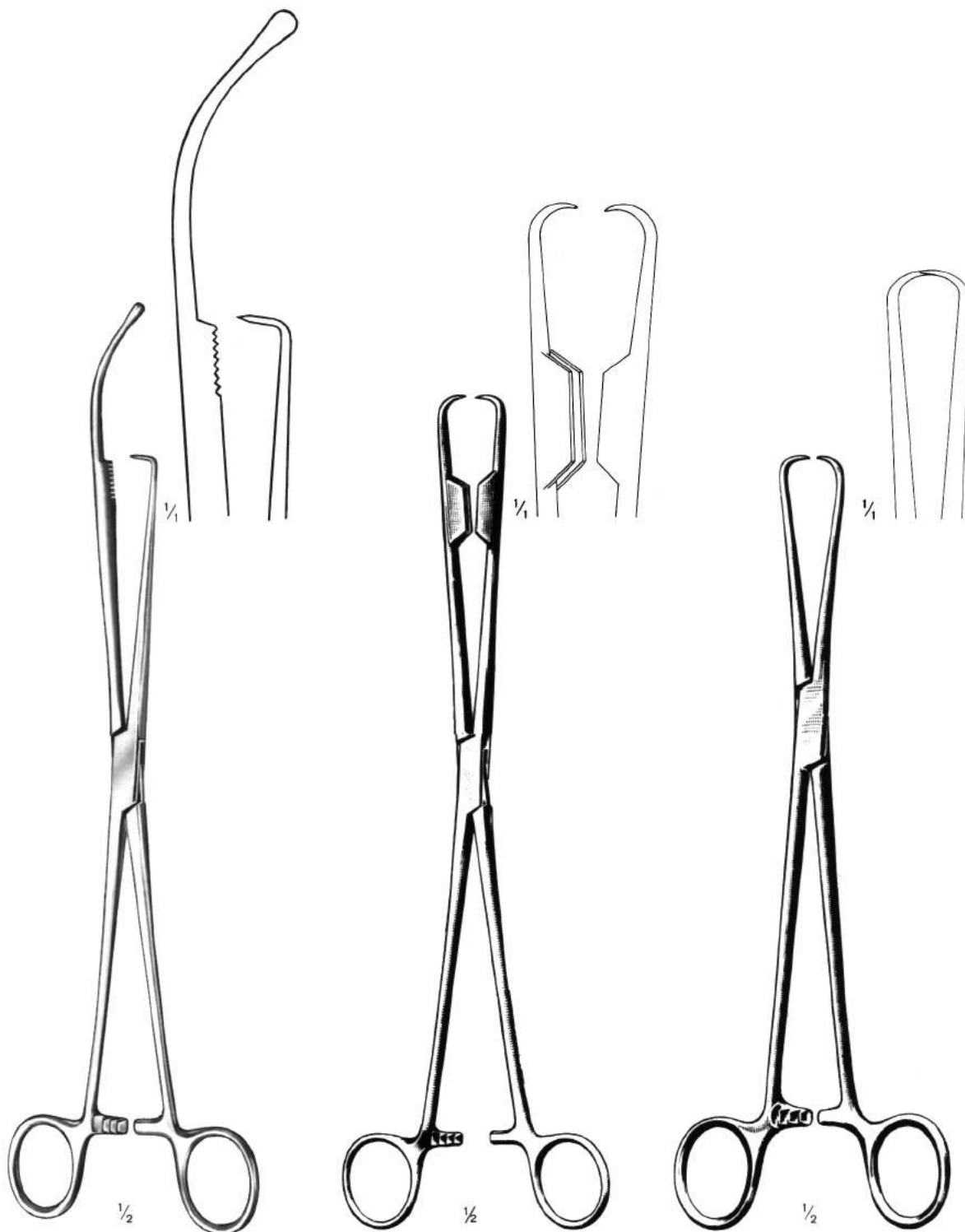

Hulka
 30 cm/12"
 D-7001.30

Abel
 27 cm/10 1/2"
 D-7010.27

Schroeder
 25 cm/10"
 D-7016.25

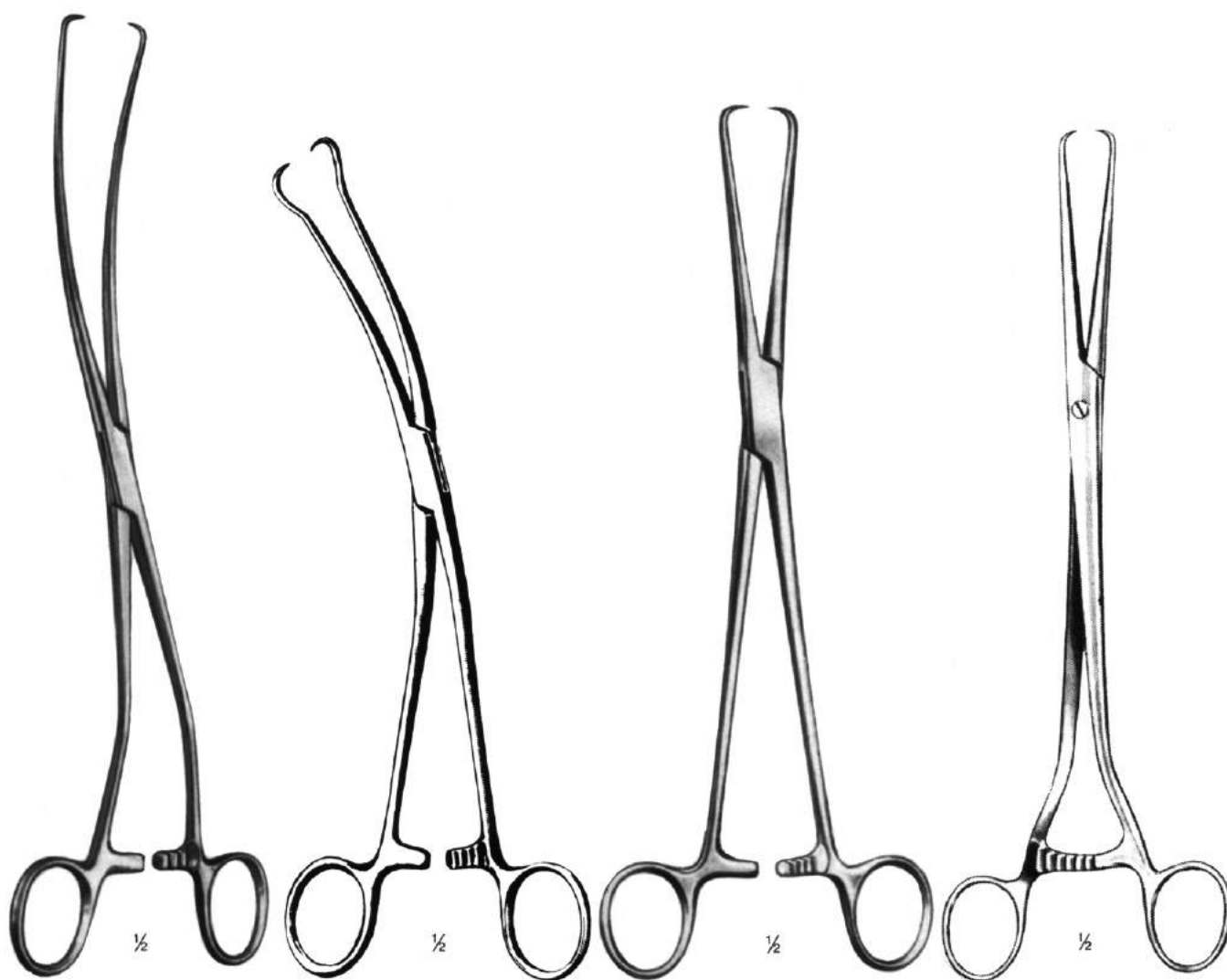

Duplay
28 cm/11"
D-7051.28

Skene
24 cm/9 1/2"
D-7053.24

Pozzi
25,5 cm/10 1/4"
D-7056.25

Collin-Pozzi
25 cm/10"
D-7058.25

Tenaculum forceps
Pinces pour abaissement du col de l'utérus
Pinzas para coger el cuello del útero

Towel Forceps

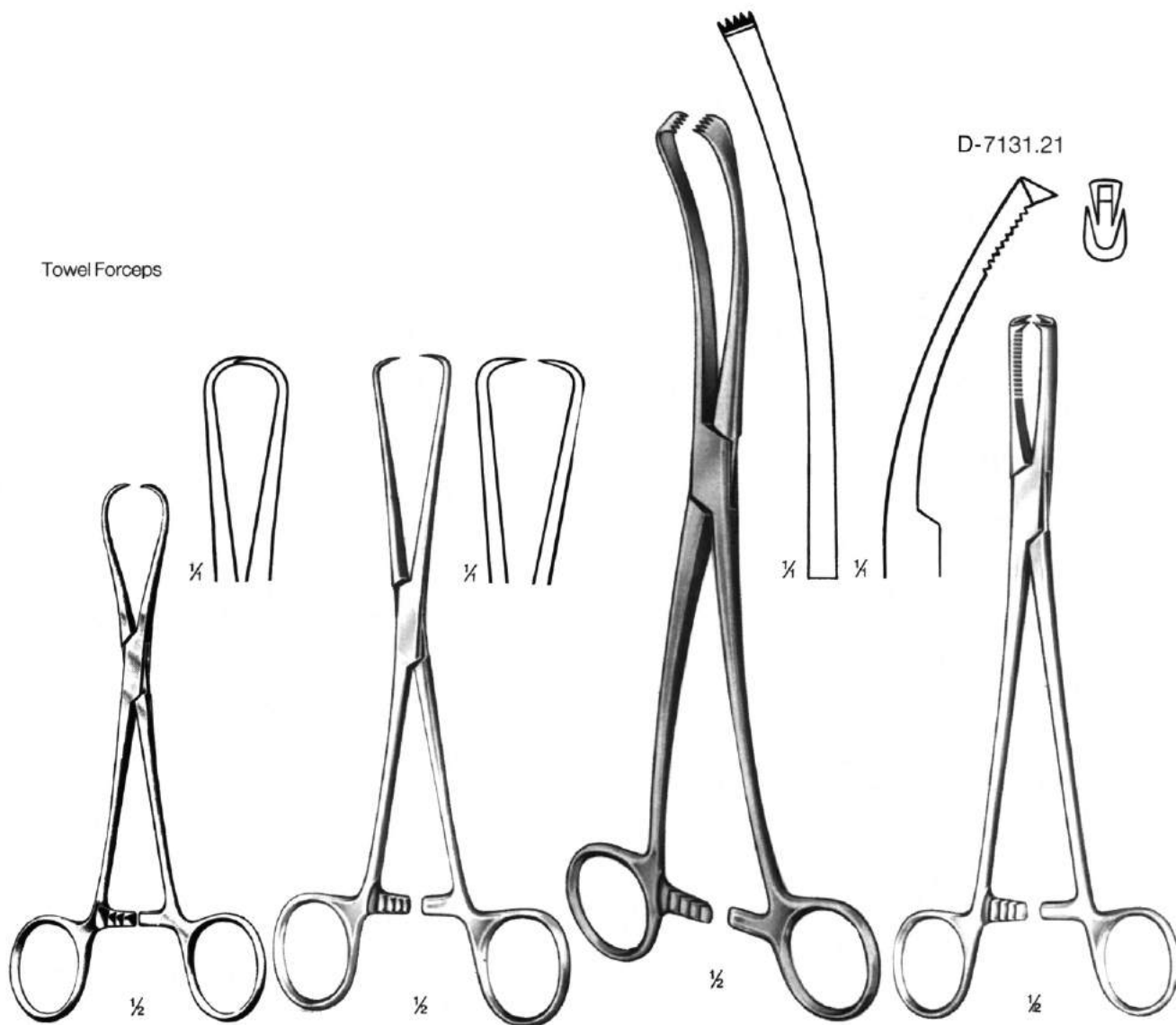

Staude-Moore (Bernhard)

17 cm/6 3/4"
 D-7082.17

Barrett

18 cm/7"
 D-7084.18

Iowa

26 cm/10 1/4"
 D-7107.26

Jacobs

21 cm/8 1/4"
 D-7130.21 straight

Tenaculum forceps
Pinces pour abaissement du col de l'utérus
Pinzas para coger el cuello del útero

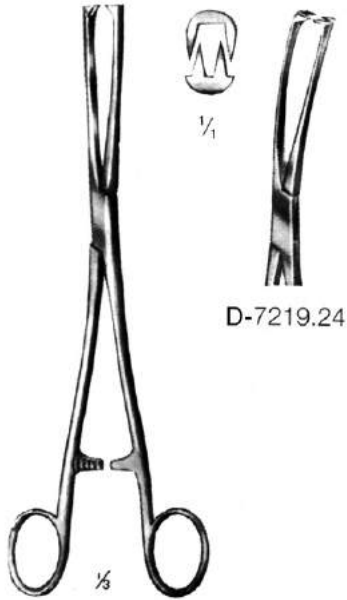

D-7219.24

Museux
 24 cm/9 1/2"
 D-7218.24

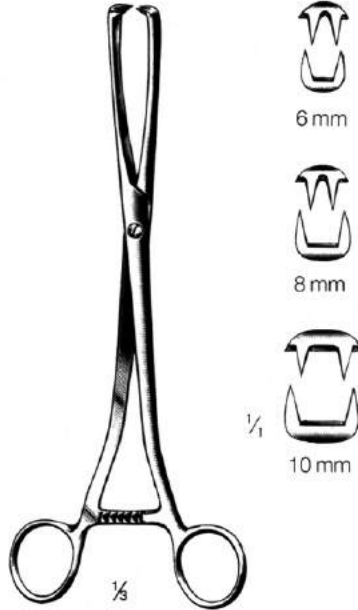

Museux
 24 cm/9 1/2"
 D-7224.06 = 6 mm
 D-7224.08 = 8 mm
 D-7224.10 = 10 mm



Museux
 24 cm/9 1/2"
 D-7225.06 = 6 mm
 D-7225.08 = 8 mm
 D-7225.10 = 10 mm



Teale
 23 cm/9"
 D-7243.23

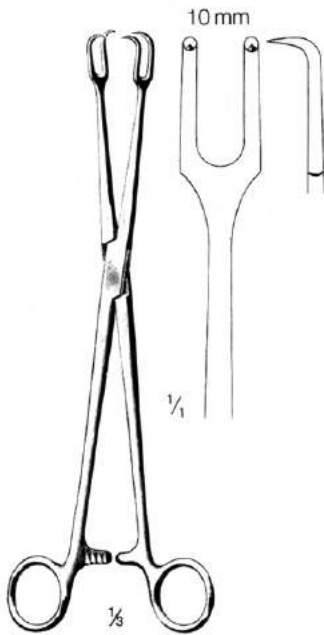

Schroeder
 24 cm/9 1/2"
 D-7400.24

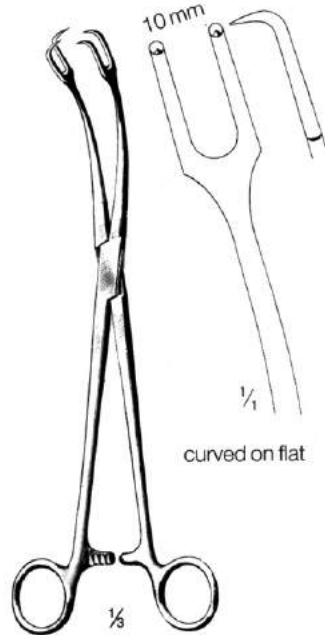

Schroeder
 24 cm/9 1/2"
 D-7401.24

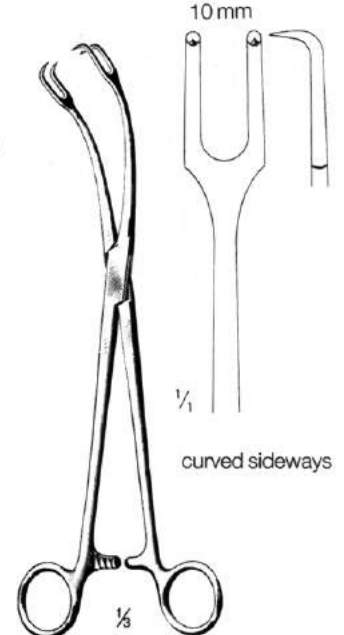

Schroeder
 24 cm/9 1/2"
 D-7403.24

Tenaculum forceps
Pinces pour abaissement du col de l'utérus
Pinzas para coger el cuello del útero

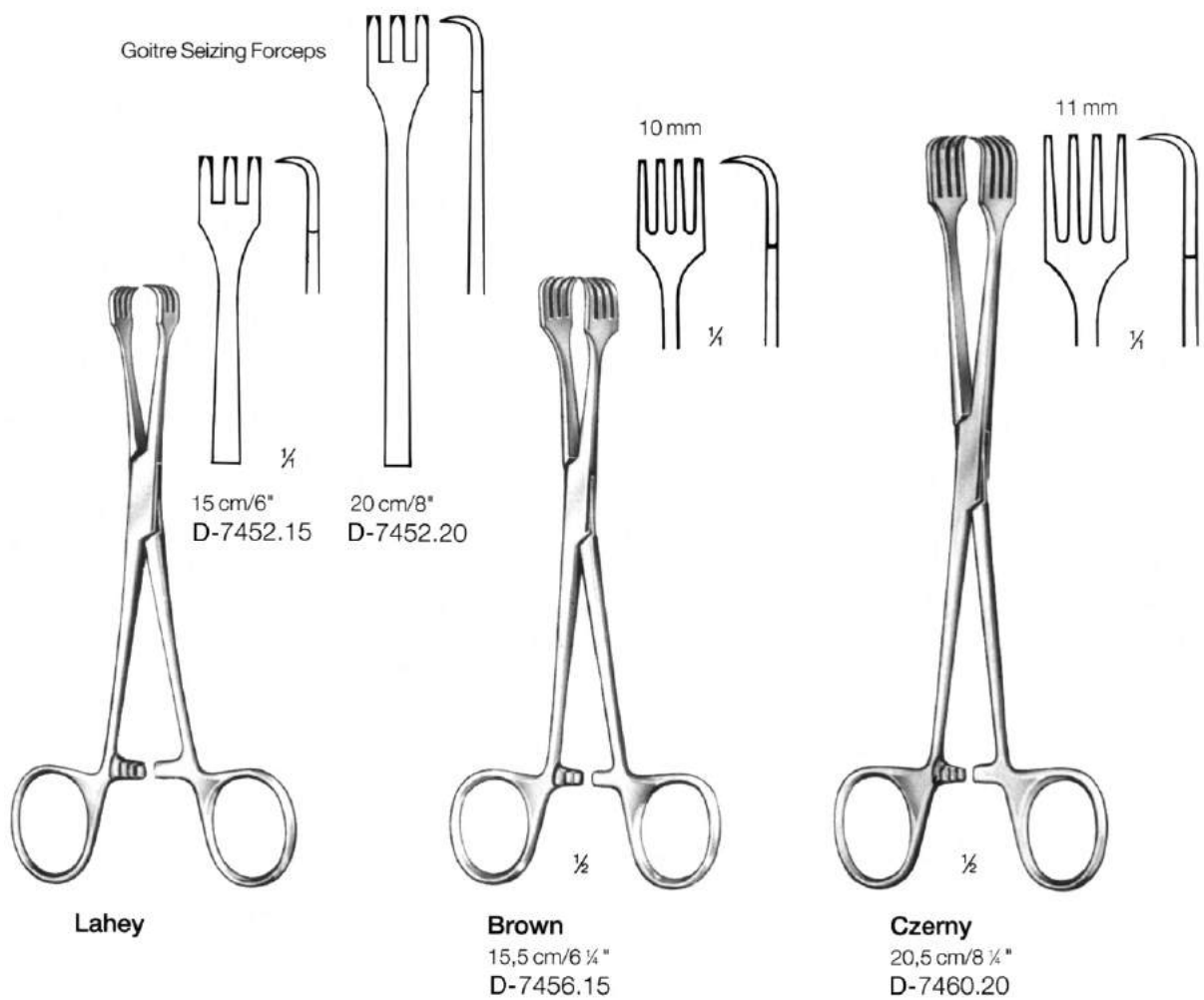

Tenaculum forceps
Pinces pour abaissement du col de l'utérus
Pinzas para coger el cuello del útero

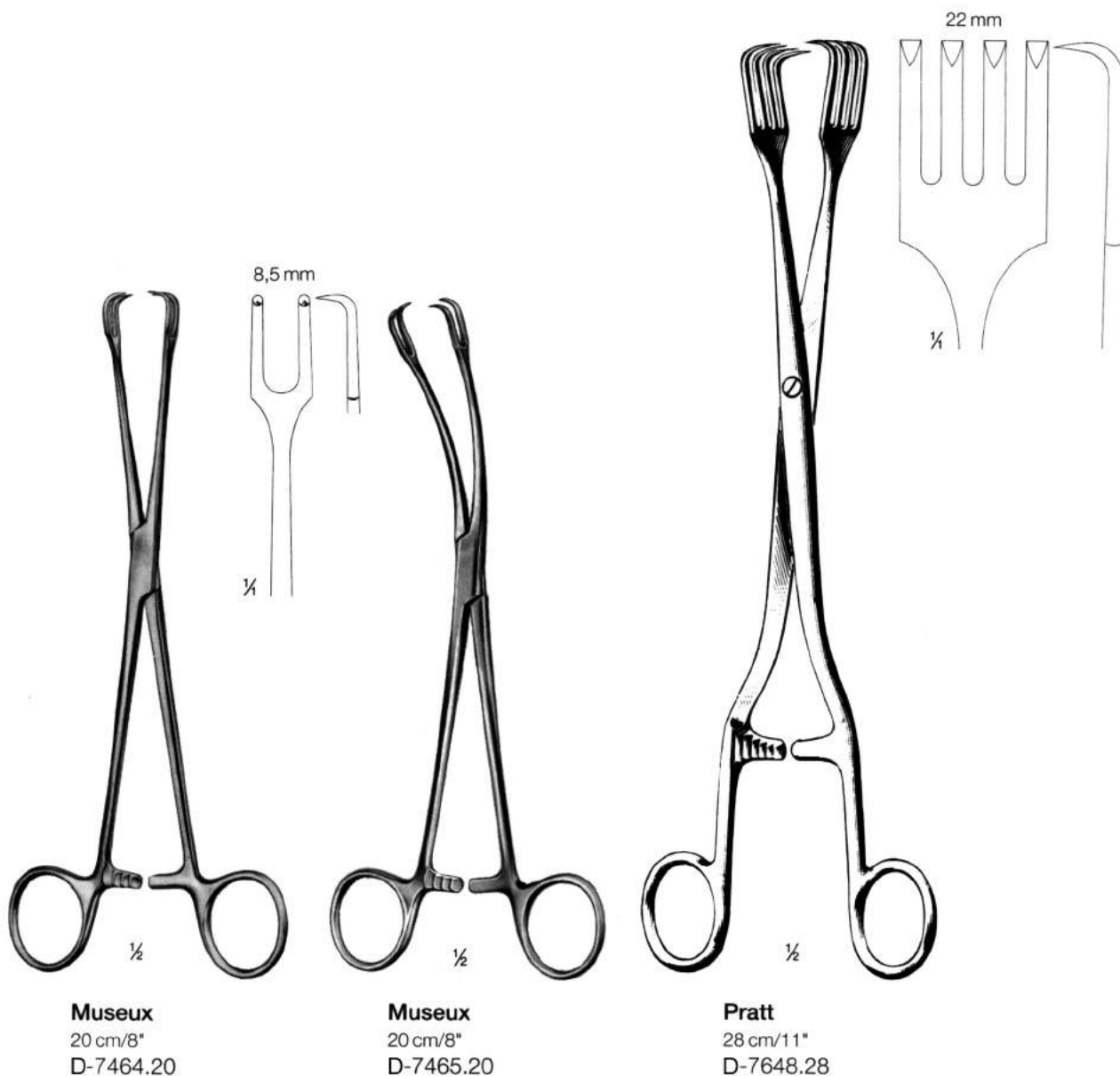

Tongue Forceps

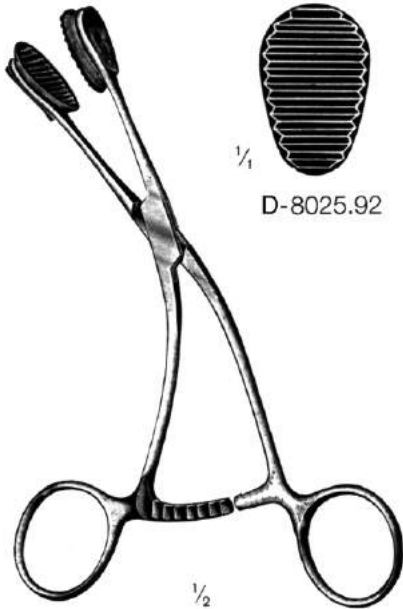

$\frac{1}{2}$
Young
17 cm/6 $\frac{1}{4}$ "
D-8025.17

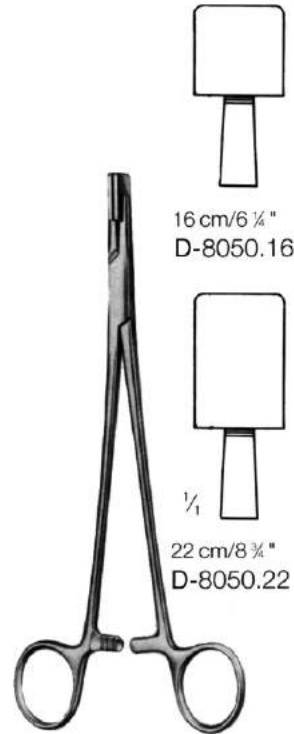

House

16 cm/6 $\frac{1}{4}$ "
D-8050.16

$\frac{1}{4}$
22 cm/8 $\frac{3}{4}$ "
D-8050.22

Tonsil Clamps

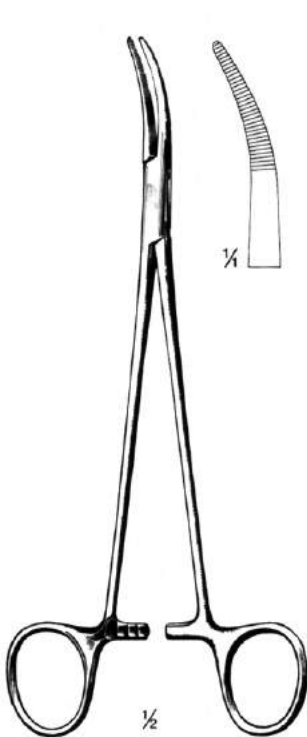

$\frac{1}{2}$
Schnidt
19 cm/7 $\frac{1}{2}$ "
D-0651.19



$\frac{1}{4}$
Schnidt (Boettcher)
19 cm/7 $\frac{1}{2}$ "
D-8115.19

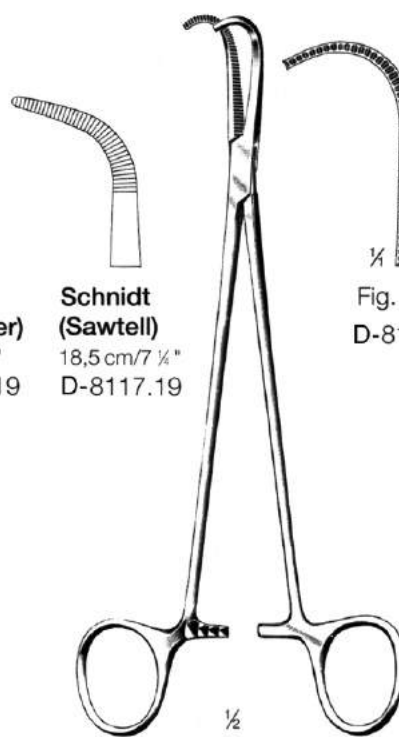

$\frac{1}{4}$
Schnidt (Sawtell)
18,5 cm/7 $\frac{1}{4}$ "
D-8117.19

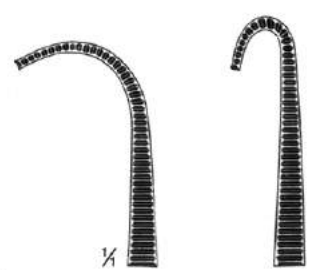

Fig. 1
D-8129.01



D-8129.02

$\frac{1}{2}$
Negus
19 cm/7 $\frac{1}{2}$ "

Tonsil seizing forceps
Pinces pour saisir les amygdales
Pinzas para coger las amígdalas

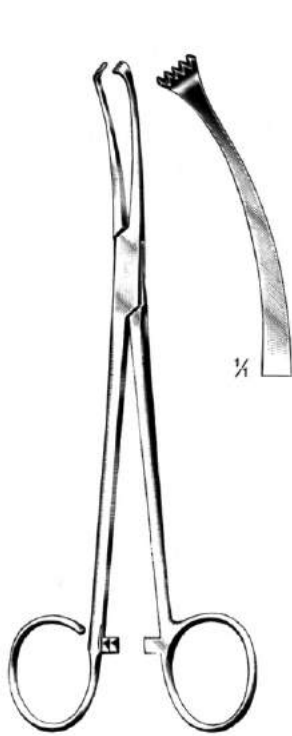

White
 18 cm/7" D-8225.18
 23 cm/9" D-8225.23

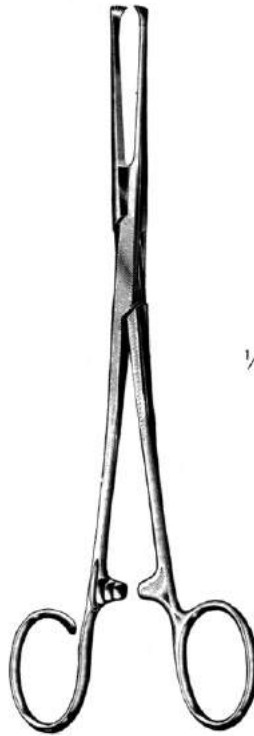

Allis-Coakley
 19 cm/7 1/2"



Allis-Coakley
 19 cm/7 1/2"
 D-8229.19

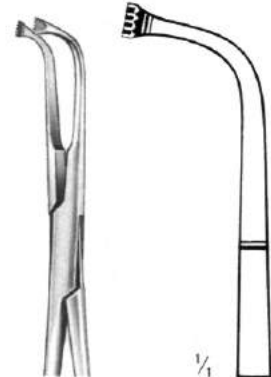

Allis-Coakley
 18,5 cm/7 1/4"
 D-8229.18



Allis
 20 cm/8"
 D-8231.20

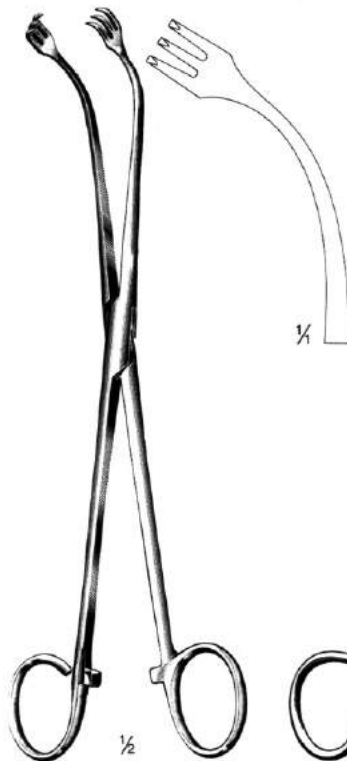

Ballenger
 21,5 cm/8 1/2"
 D-8241.21

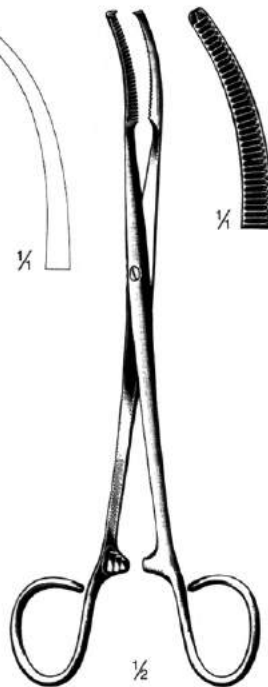

Mikulicz
 18 cm/7"
 D-8245.18



Blohmke
 20 cm/8"
 D-8257.20

Towel forceps
Pinces à compresses, pincés à champs
Pinzas para compresas, pinzas de campo



Jones
 9 cm/3 1/2"
 D-9013.09



Schaedel
 9 cm/3 1/2"
 D-9021.09



Doyen
 18 cm/7"
 D-9043.18



Lane	
cm	inch.
15	6
20	8



Backhaus	
cm	inch.
9	3 1/2
11	4 1/2
13	5
15	6



Röder

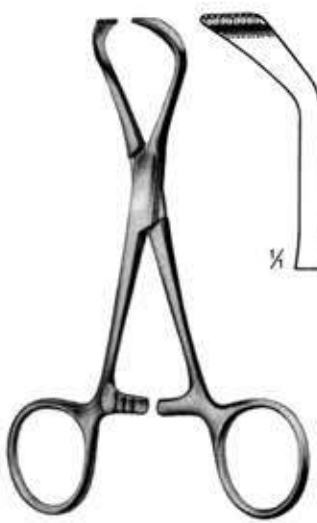

Lorna

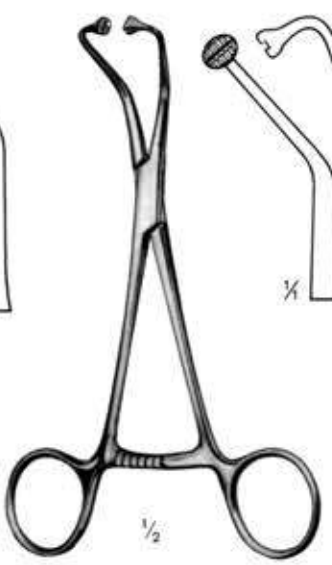

Peers



Robin

cm	inch.
10	4
13	5
14,5	5 3/4
15	6

5 mm	D-9213.05
13 mm	D-9213.13

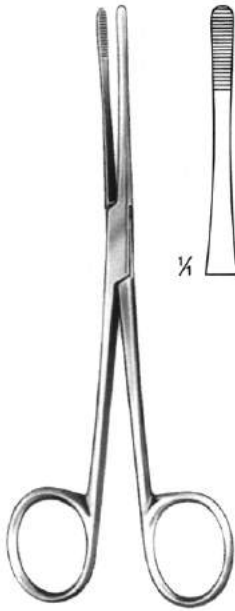

cm	inch.	Lister
13	5	D-9306.13
15	6	D-9306.15
18	7	D-9306.18

Gall Stone Forceps



11,0 cm, 4 3/8"
D-9066.11

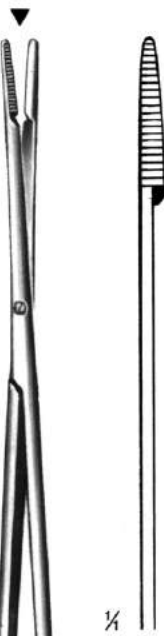

1/4
D-9346.25



D-9347.25

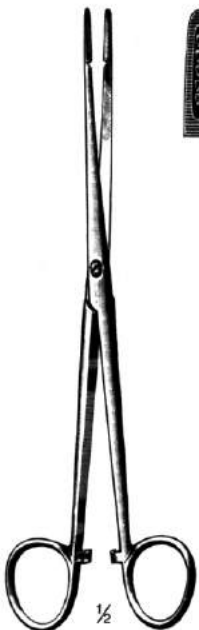

Walton
17 cm/8 3/4"
D-9320.17



D-9321.17



Pelkann
25 cm/10"

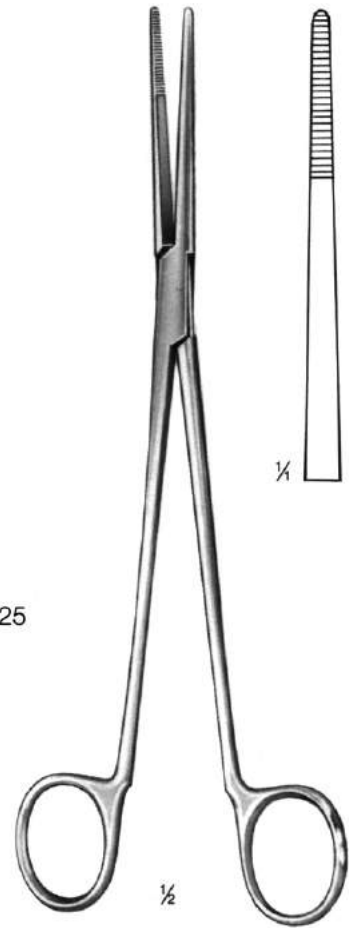

Westermark
23,5 cm/9 1/4"
D-9350.23



Gross
20 cm/8"

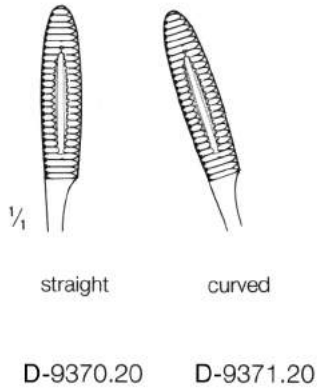

Gross
20 cm/8"

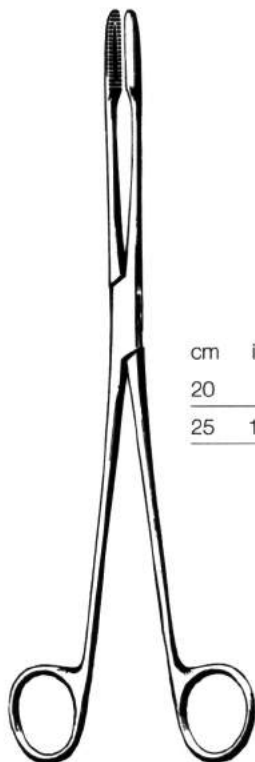
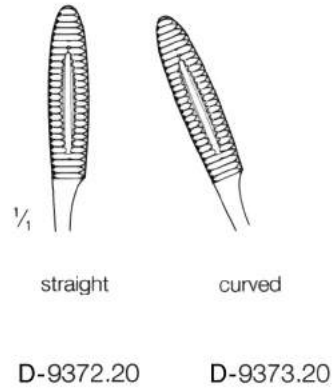

Gross-Maier

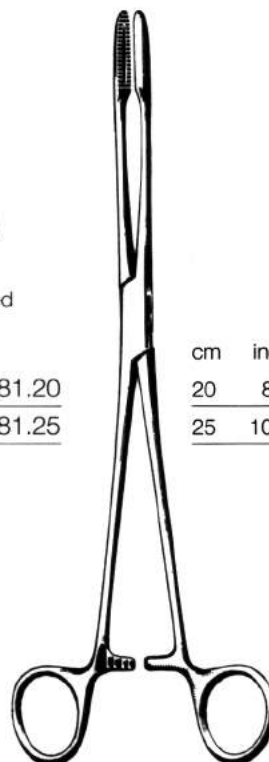
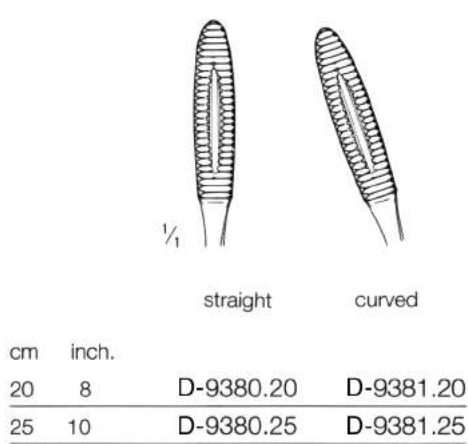

Gross-Maier

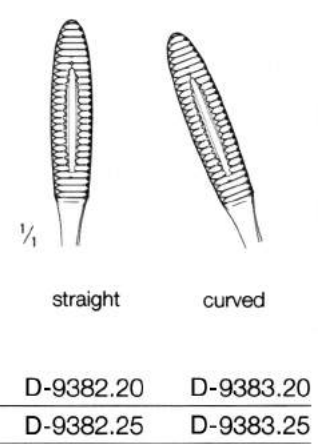

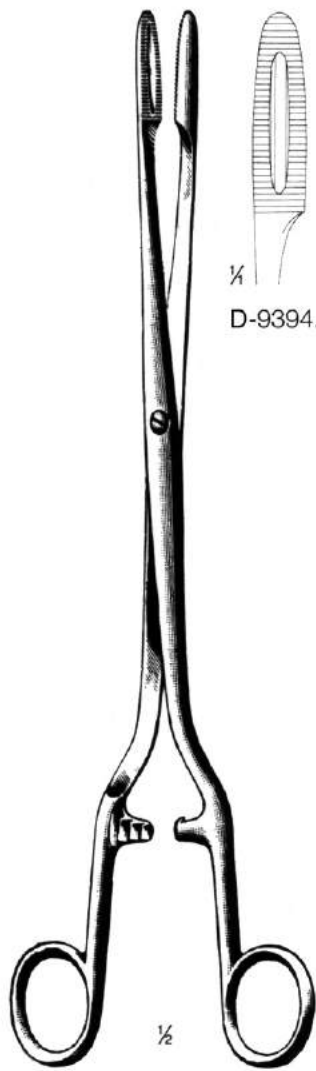

Sims-Maier
28 cm/11"



D-9394.28



D-9395.28

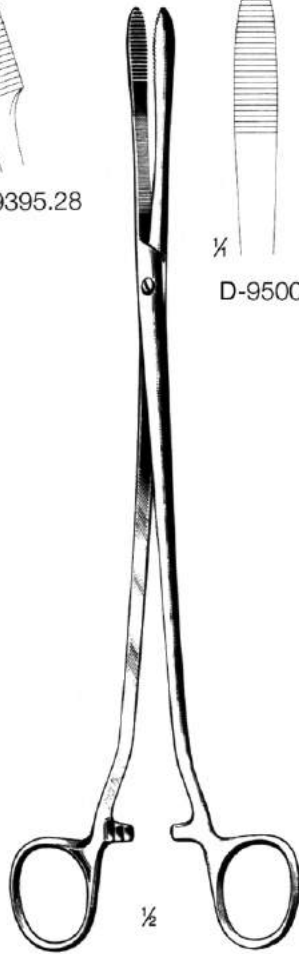

Collin
25 cm/10"



D-9500.25



D-9501.25

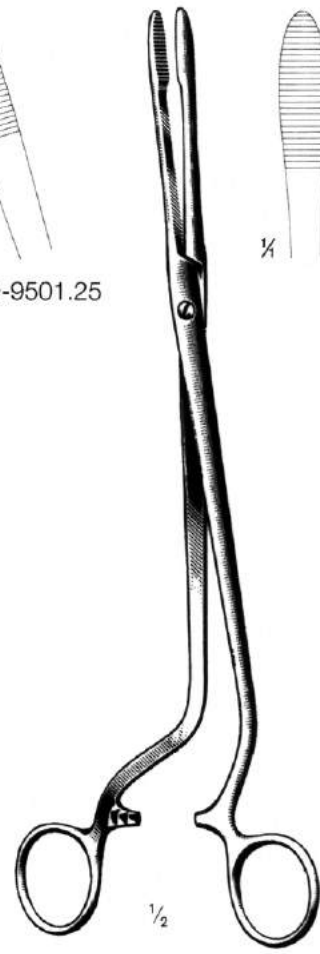

Cheron
25 cm/10"
D-9503.25





Ulrich
 D-9510.18 = 18 cm/7"
 D-9510.20 = 20 cm/8"
 D-9510.25 = 25 cm/10"

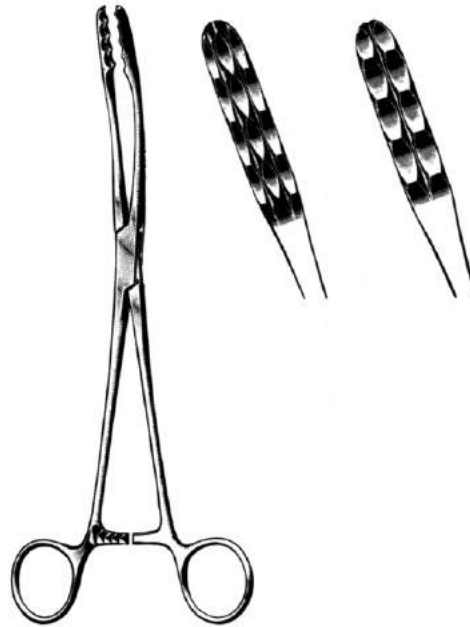

Ulrich
 D-9511.18 = 18 cm/7"
 D-9511.20 = 20 cm/8"
 D-9511.25 = 25 cm/10"

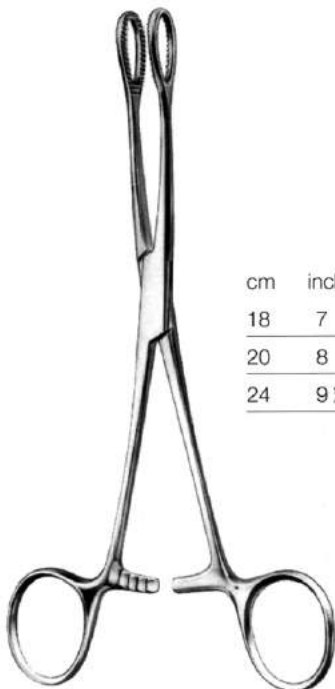

**Foerster
 (Ballenger)**

cm	inch.				
18	7	D-9520.18	D-9521.18	D-9522.18	D-9523.18
20	8	D-9520.20	D-9521.20	D-9522.20	D-9523.20
24	9½	D-9520.24	D-9521.24	D-9522.24	D-9523.24

smooth jaws

serrated jaws

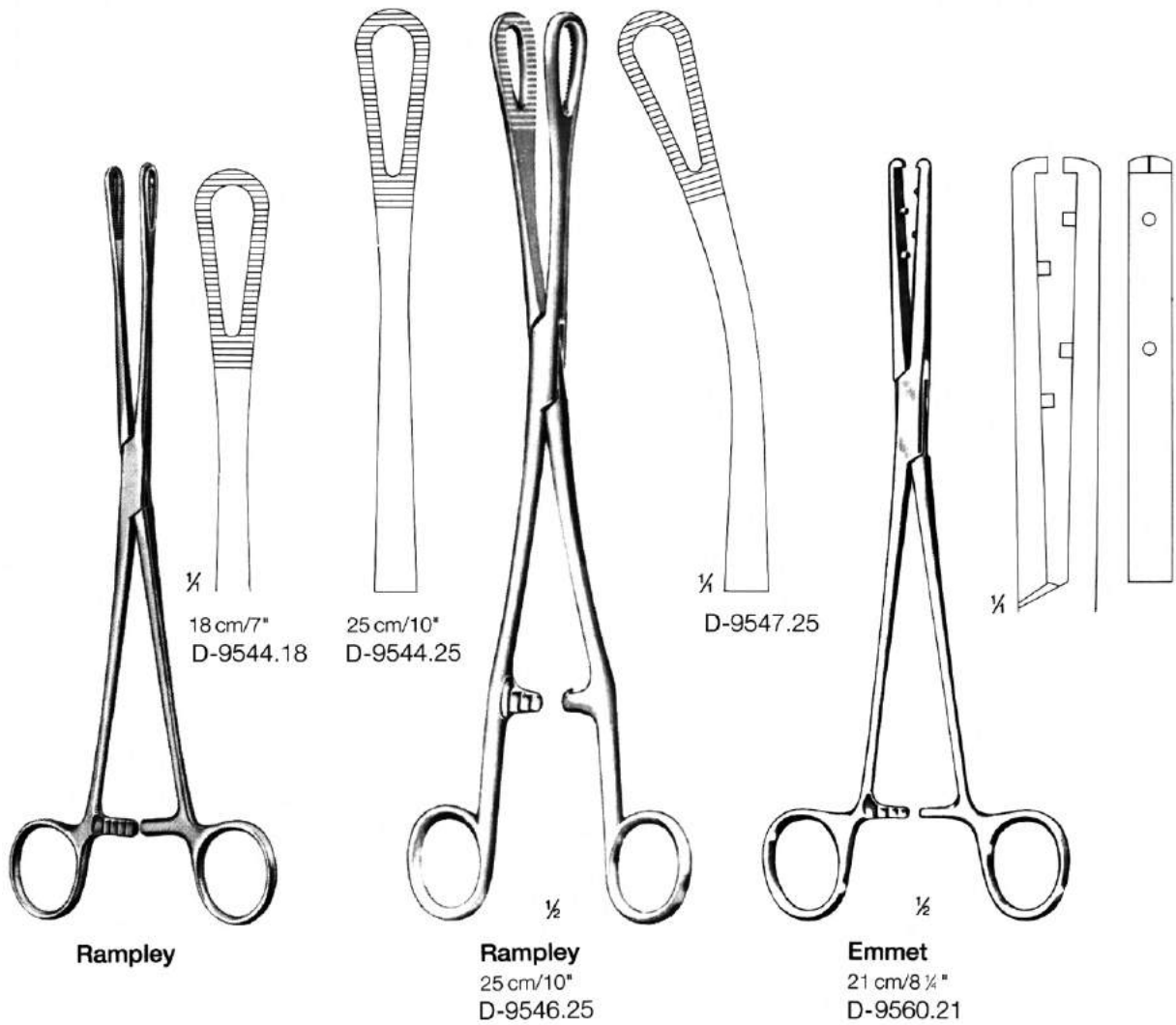

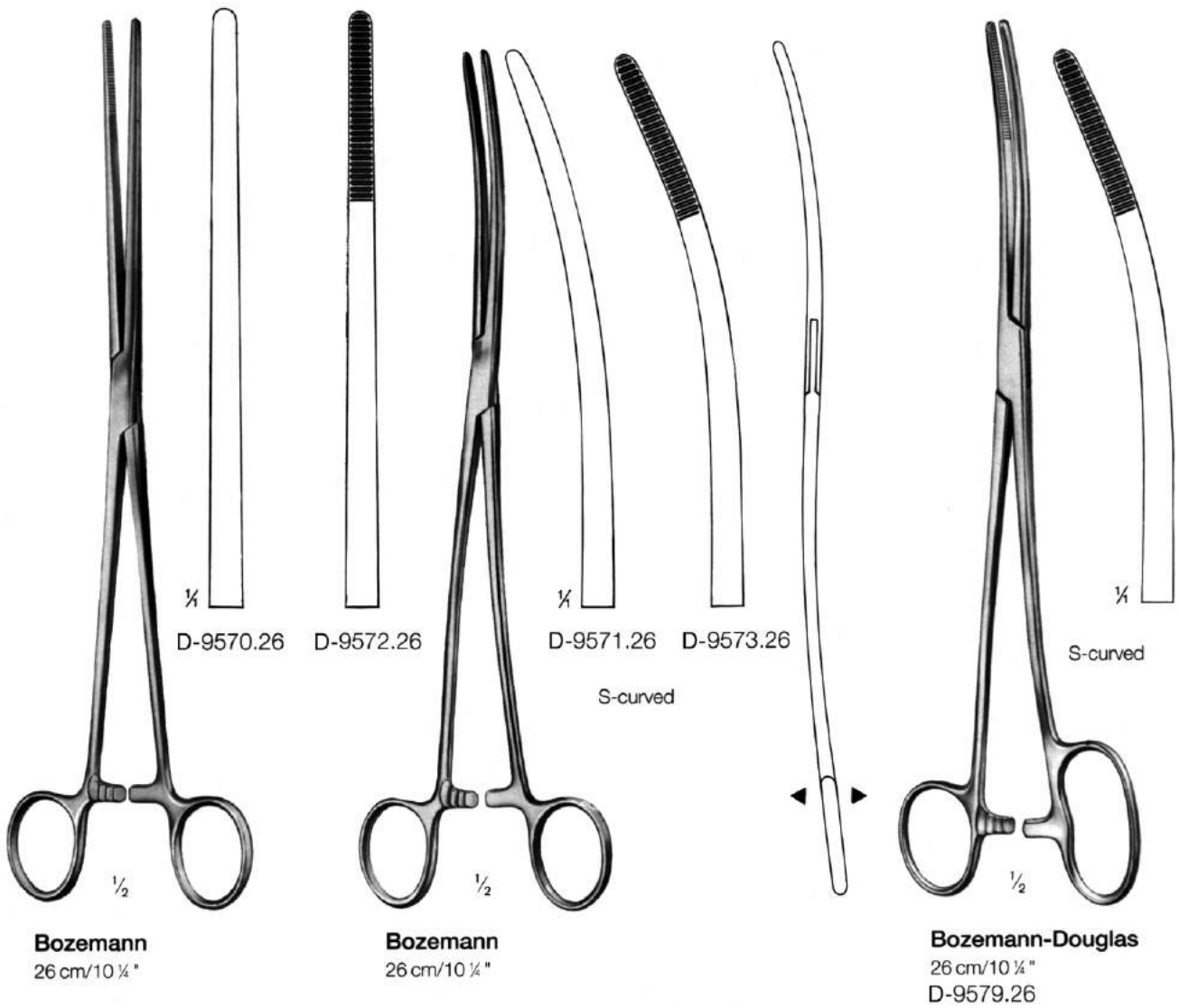

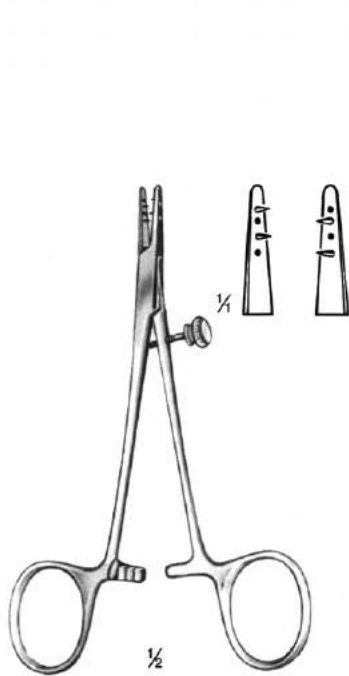

Steinmann
13 cm/5"
D-9650.13

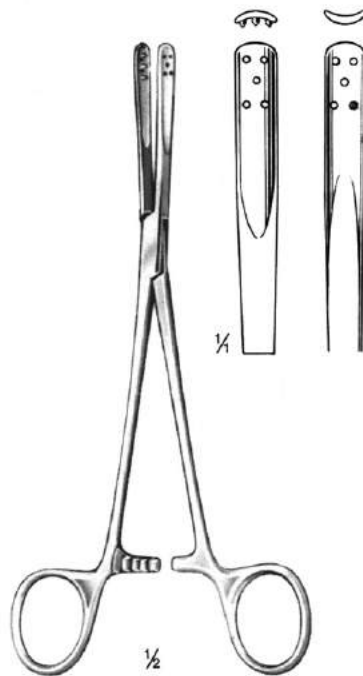

Brand
15,5 cm/5 1/4"
D-9670.15

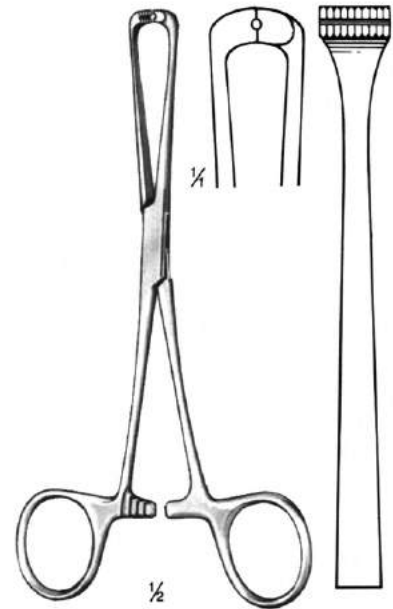

Steinmann
16 cm/6 1/4"
D-9680.16

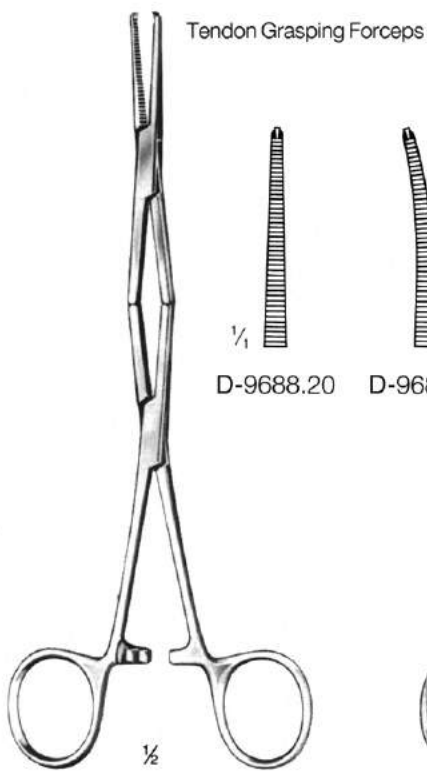

20,5 cm/8"

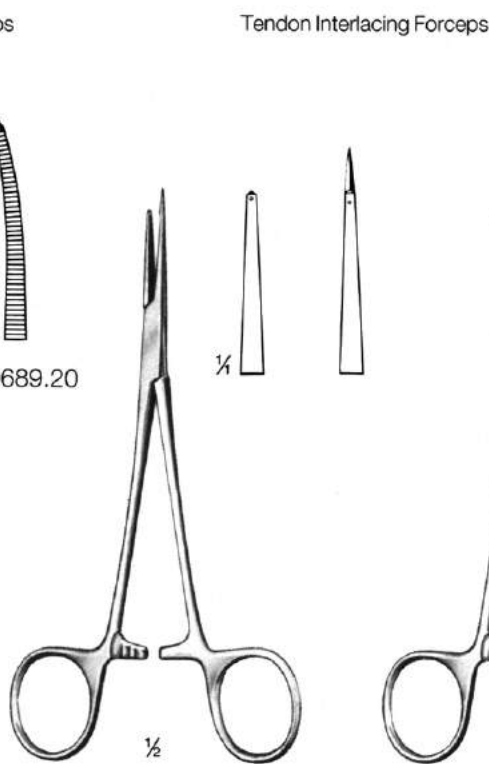
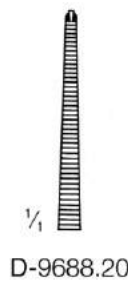

15 cm/6"
D-9690.15

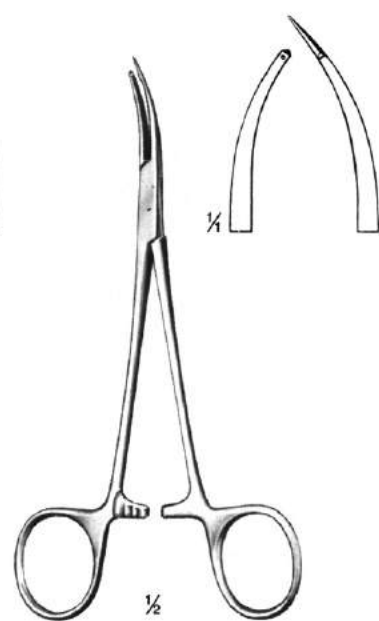

15 cm/6"
D-9691.15

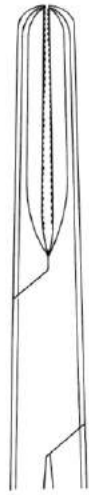
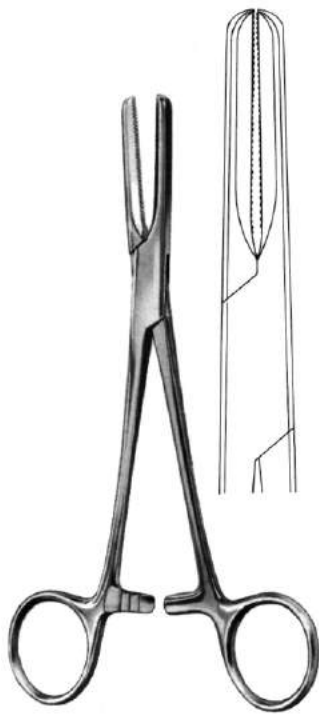

15 cm/6"
D-9900.15



18 cm/7"
D-9900.18



20 cm/8"
D-9900.20

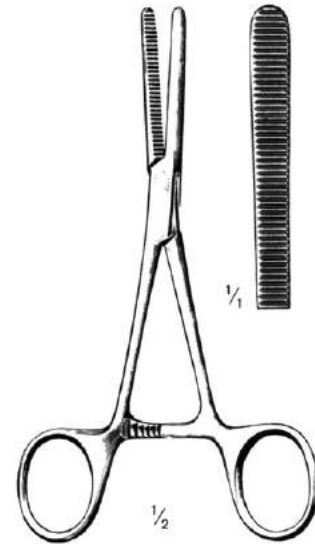

Mod. Klinikum Berlin
14,5 cm/5 3/4"
D-9906.14

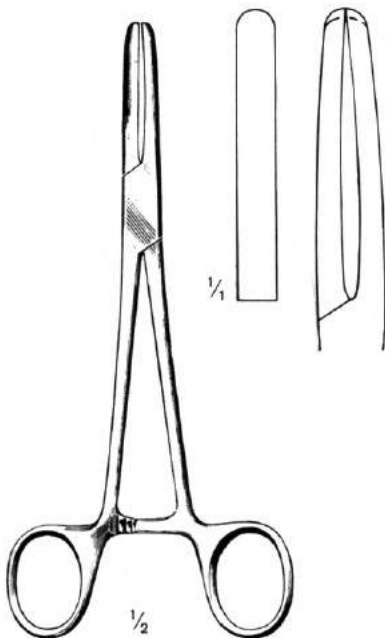

Presbyterian-Hospital
16,5 cm/6 1/2"
D-9912.16



Baxter (Simplex)
12 mm
D-9928.12



Mohr
D-9920.40 = 40 mm
D-9920.50 = 50 mm
D-9920.60 = 60 mm
D-9920.70 = 70 mm
D-9920.80 = 80 mm

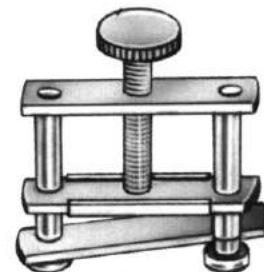

Hoffmann
D-9930.20

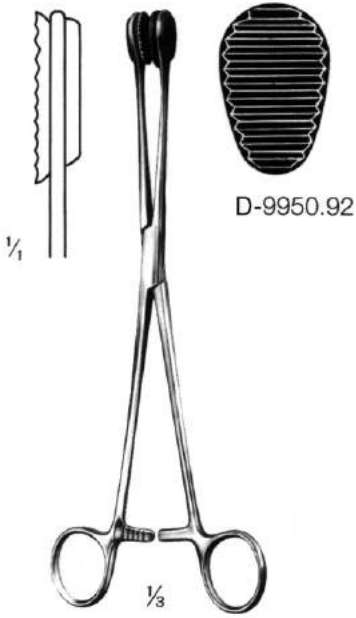

Child
24 cm/9 1/2"
D-9950.24



Rogge
23 cm/9"
D-9954.23

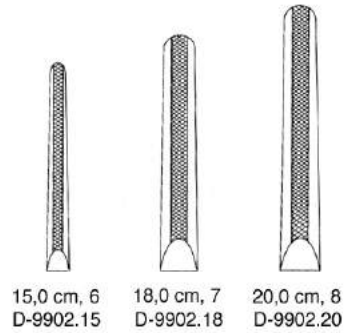

D-9952.20=20 cm/9"
D-9952.30=30 cm/12"



Cheatle
27 cm/10 1/2"
D-9955.27



Sauerbruch
55 cm/22"
D-9968.55

Catheter Introducing Forceps



15,5 cm/6"
D-9975.15
pediatric size



20 cm/8"
D-9975.20
for children



25,5 cm/10"
D-9975.25
for adults

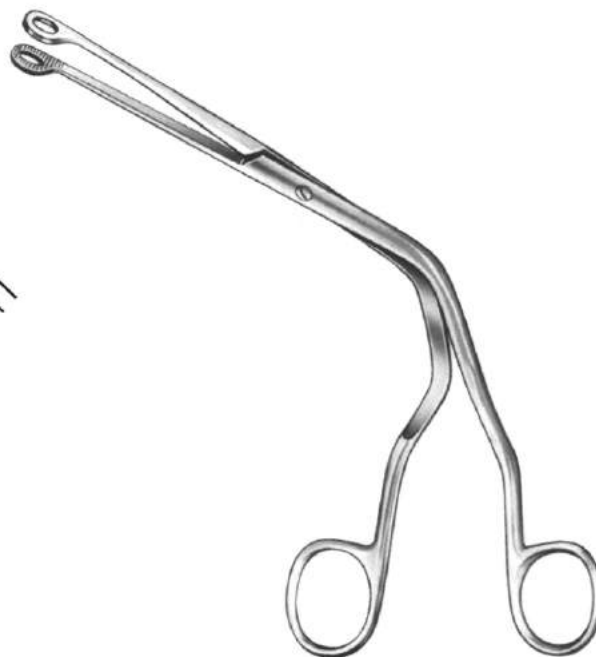

Magill

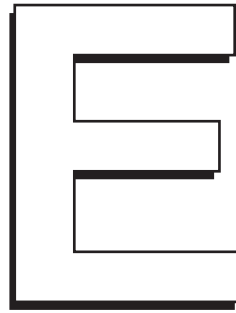

- Suture
- Suture
- Sutura



RAGHEB LIGATURE
18 cm
E-0700.18



Kronecker **Kronecker**
14 cm/5 1/2" 14 cm/5 1/2"
E-0714.01 E-0714.02
blunt blunt

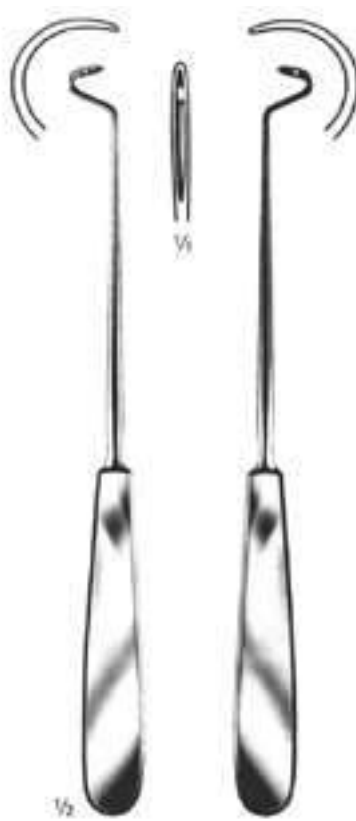

Deschamps **Deschamps**
20 cm/8" 20 cm/8"
E-0720.11 E-0720.12
blunt blunt



Deschamps **Deschamps**
20 cm/8" 20 cm/8"
E-0720.13 E-0720.14
sharp sharp

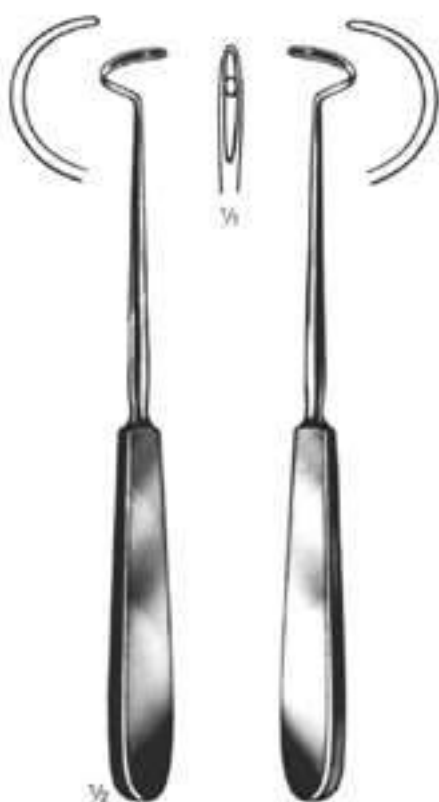

$\frac{1}{2}$
Deschamps
20 cm/8"
E-0720.21
blunt

Deschamps
20 cm/8"
E-0720.22
blunt



$\frac{1}{2}$
Deschamps
20 cm/8"
E-0720.23
sharp

Deschamps
20 cm/8"
E-0720.24
sharp



Deschamps
21 cm/8 1/4"
E-0721.21
blunt

Deschamps
21 cm/8 1/4"
E-0721.22
blunt

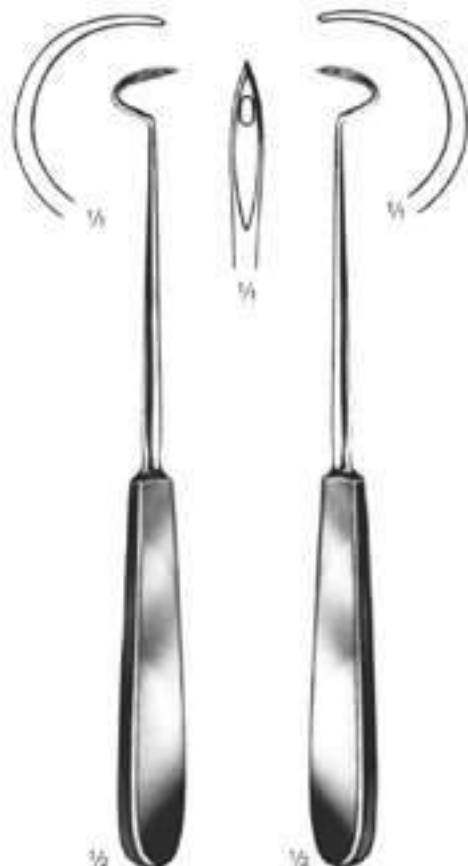

Deschamps
21 cm/8 1/4"
E-0721.23
sharp

Deschamps
21 cm/8 1/4"
E-0721.24
sharp



Deschamps
22,5 cm/9"
E-0722.01
blunt

Deschamps
22,5 cm/9"
E-0722.02
blunt



Deschamps
22,5 cm/9"
E-0722.03
blunt

Deschamps
22,5 cm/9"
E-0722.04
blunt



Deschamps
22,5 cm/9"
E-0722.21
blunt

Deschamps
22,5 cm/9"
E-0722.22
blunt

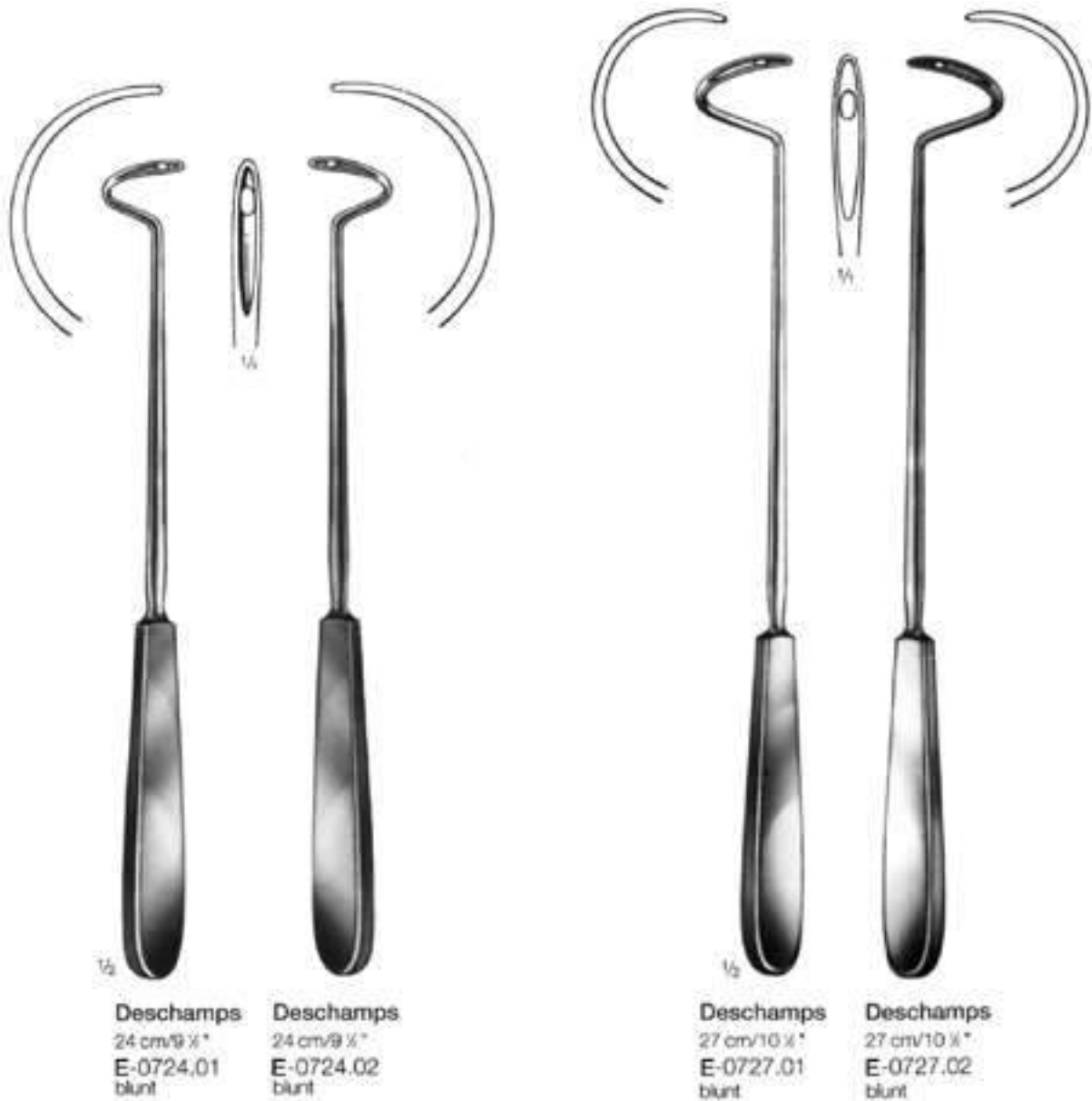



Deschamps
27 cm/10 3/4"
E-0727.03
sharp

Deschamps
27 cm/10 3/4"
E-0727.04
sharp

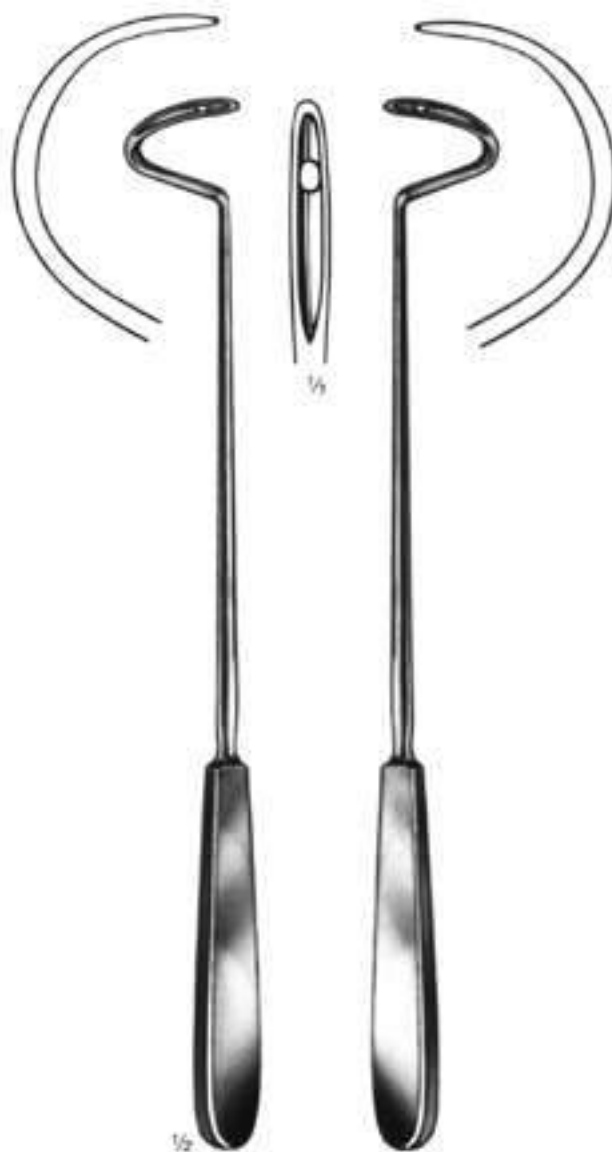

Deschamps
28 cm/11"
E-0728.01
blunt

Deschamps
28 cm/11"
E-0728.02
blunt



$\frac{1}{2}$
Narath
22 cm/8 1/2"
E-0750.22



$\frac{1}{2}$
Schmieden
21 cm/8 1/4"
E-0754.21



$\frac{1}{2}$
Kocher
19 cm/7 1/2"



E-0759.01 E-0759.02



$\frac{1}{2}$
E-0759.03

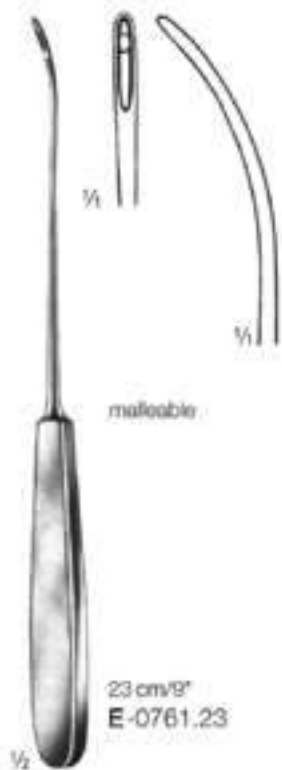

23 cm/9"
E-0761.23



Cooper
19 cm/7 1/2"
E-0765.19

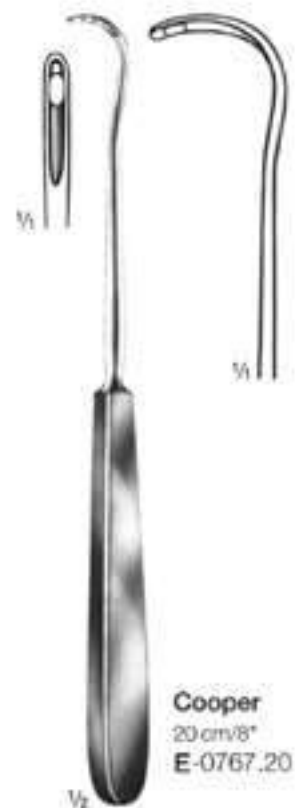

Cooper
20 cm/8"
E-0767.20

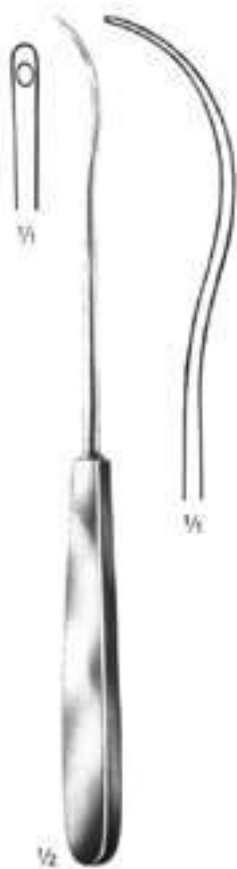

Deschamps
23 cm/9"
E-0774.23

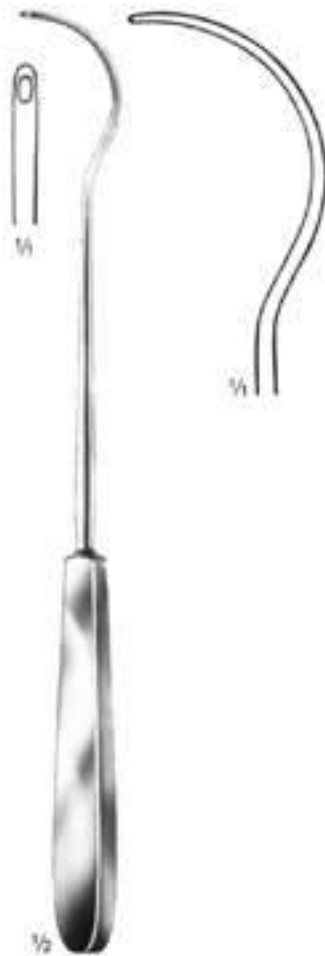

Brunner
25 cm/10"
E-0783.25



Brunner
30 cm/12"

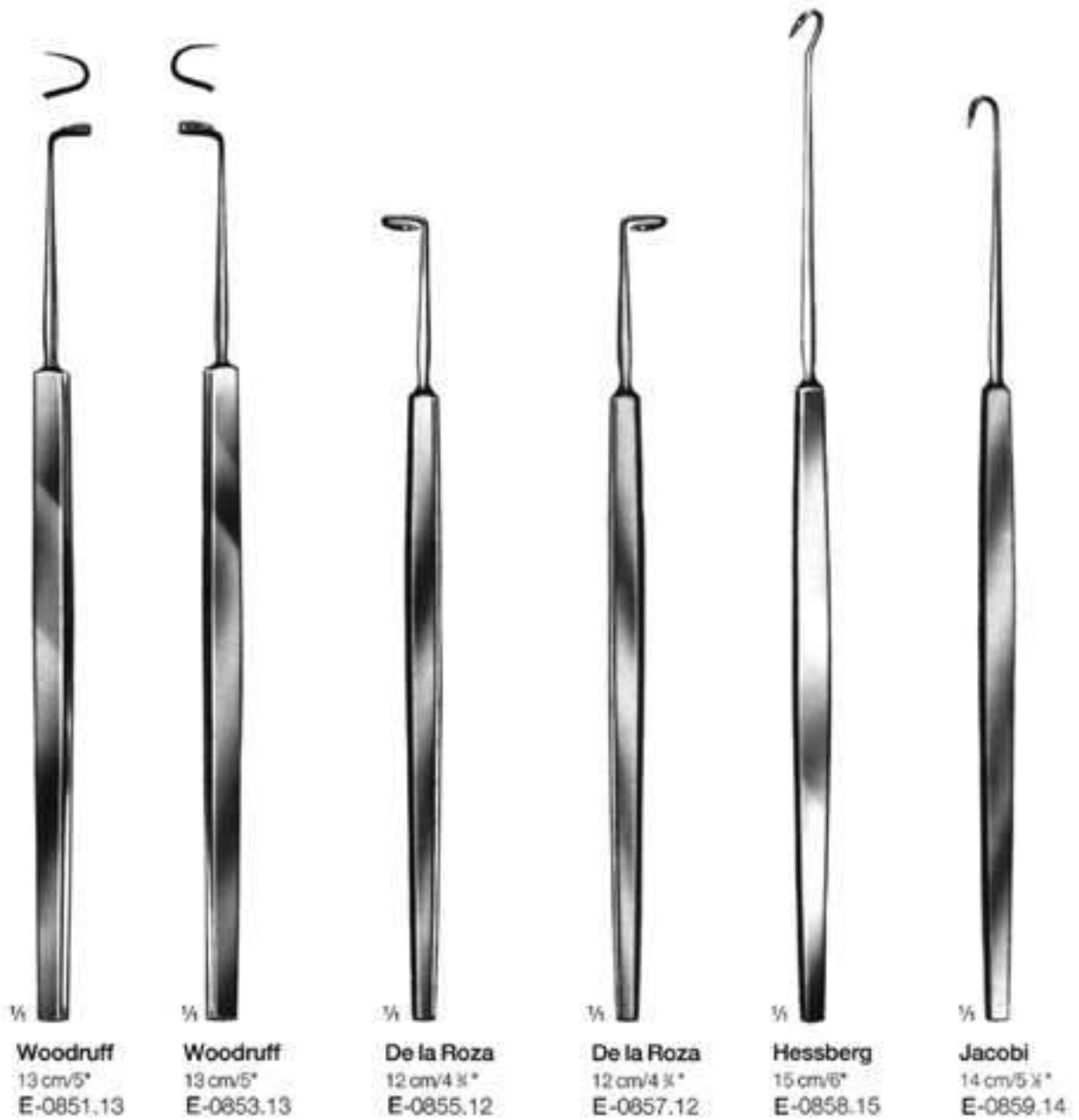



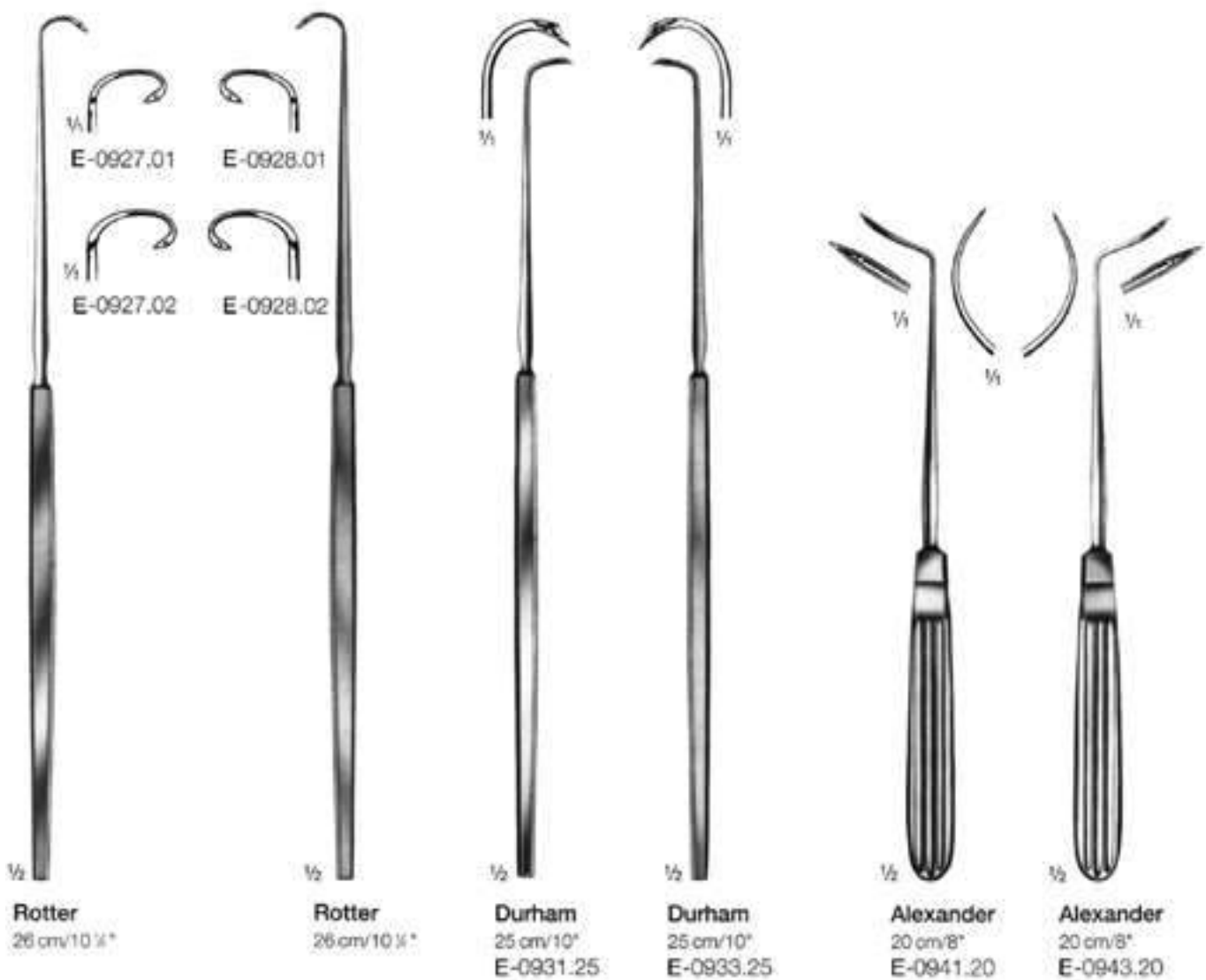

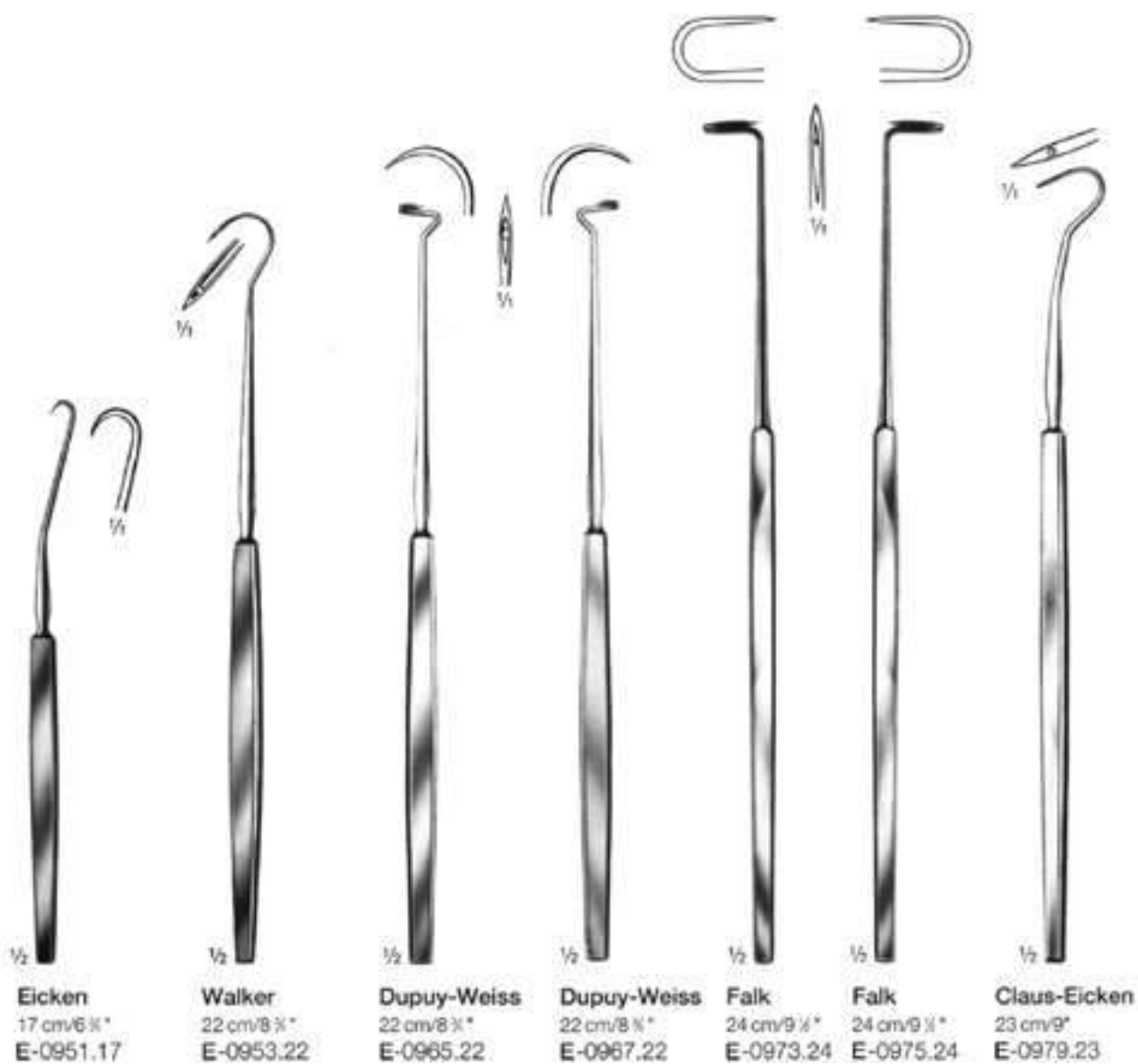

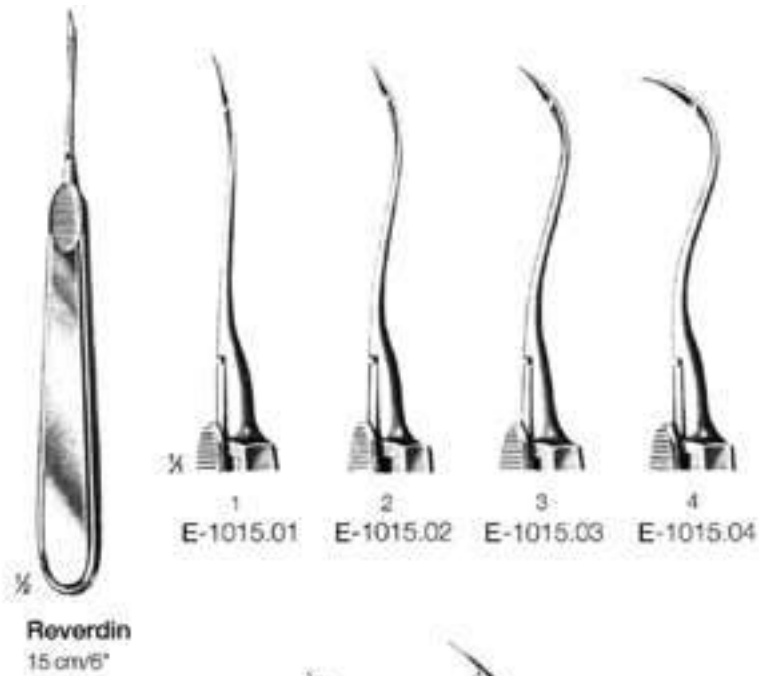





Brunner
25 cm/10"
E-2041.25



Kirschner
25,5 cm/10"
E-2045.25

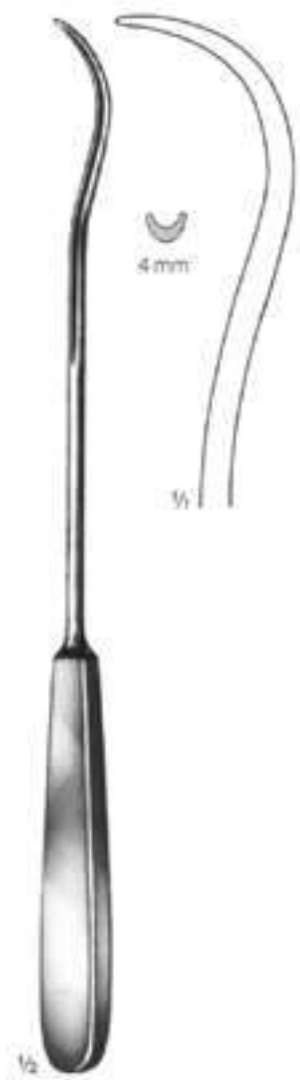

28 cm/11"
E-2054-28

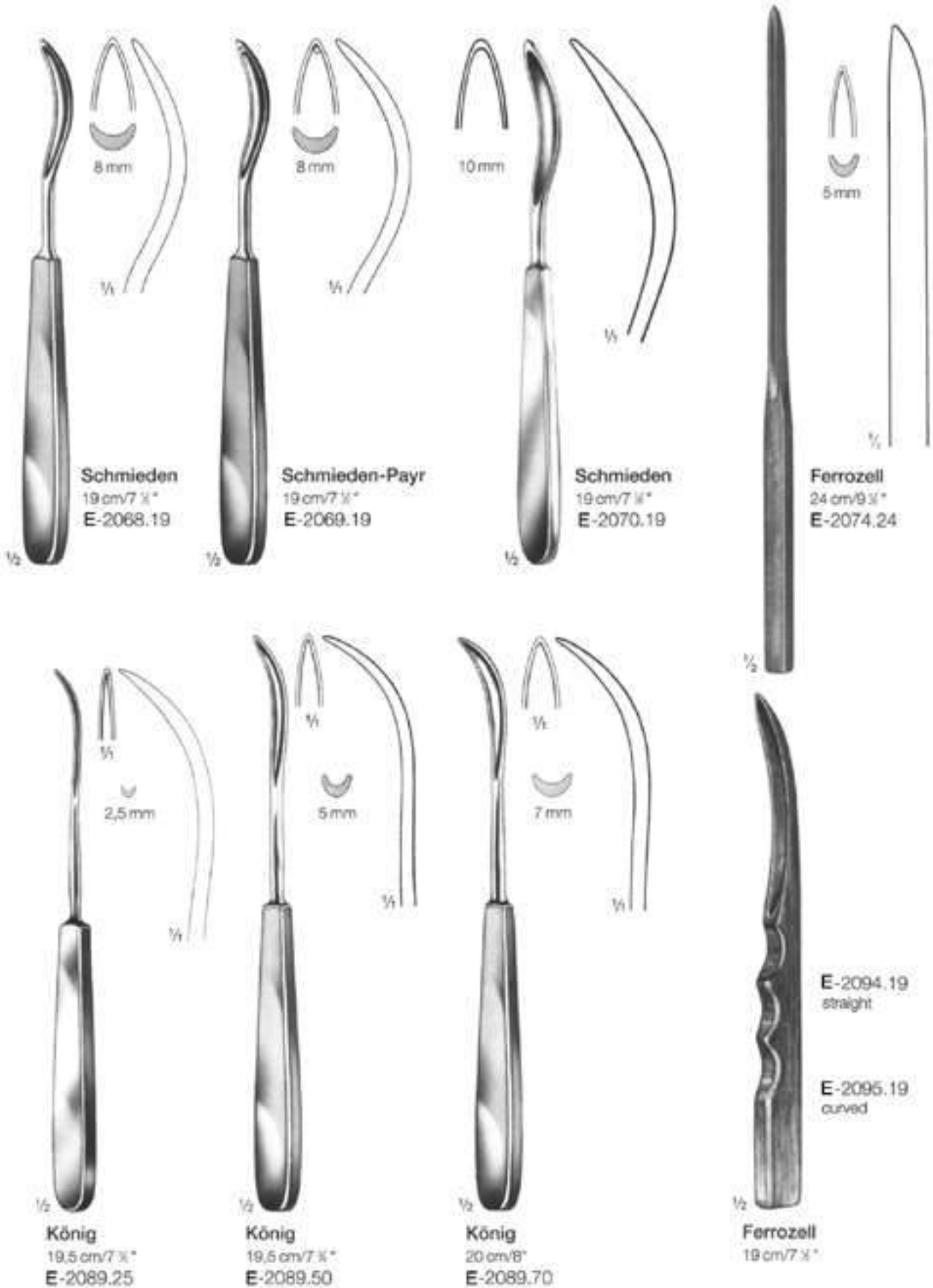

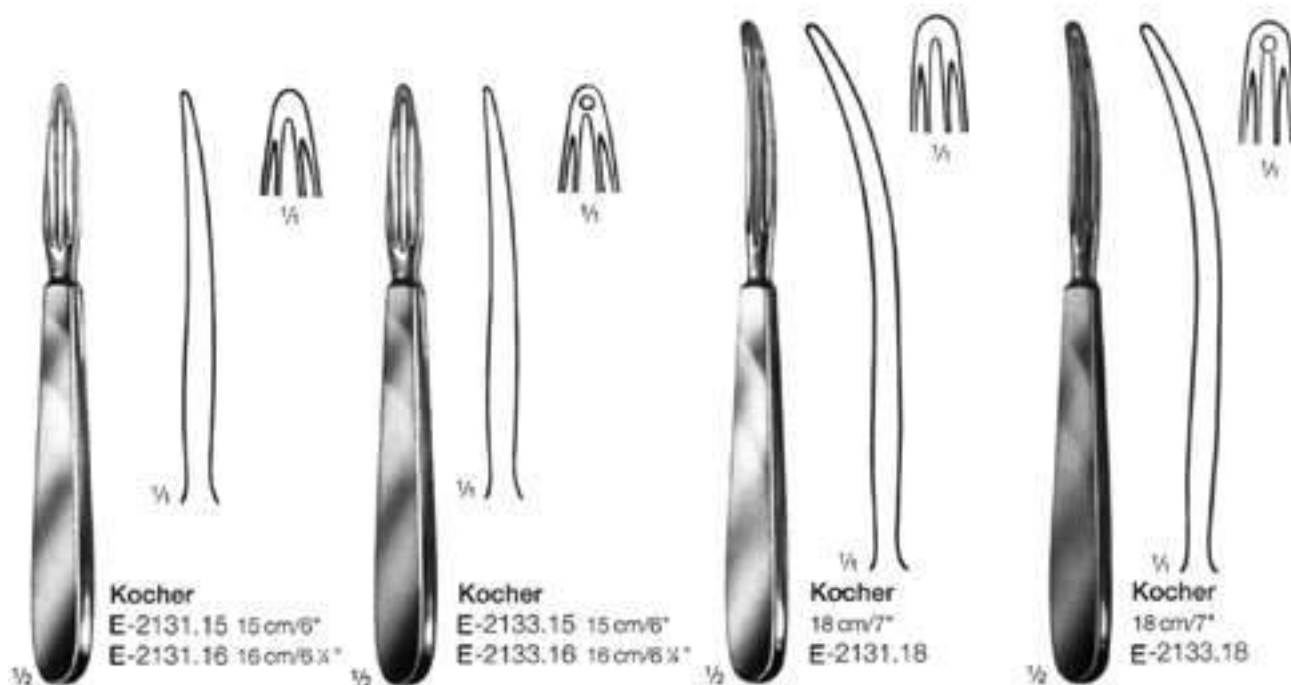
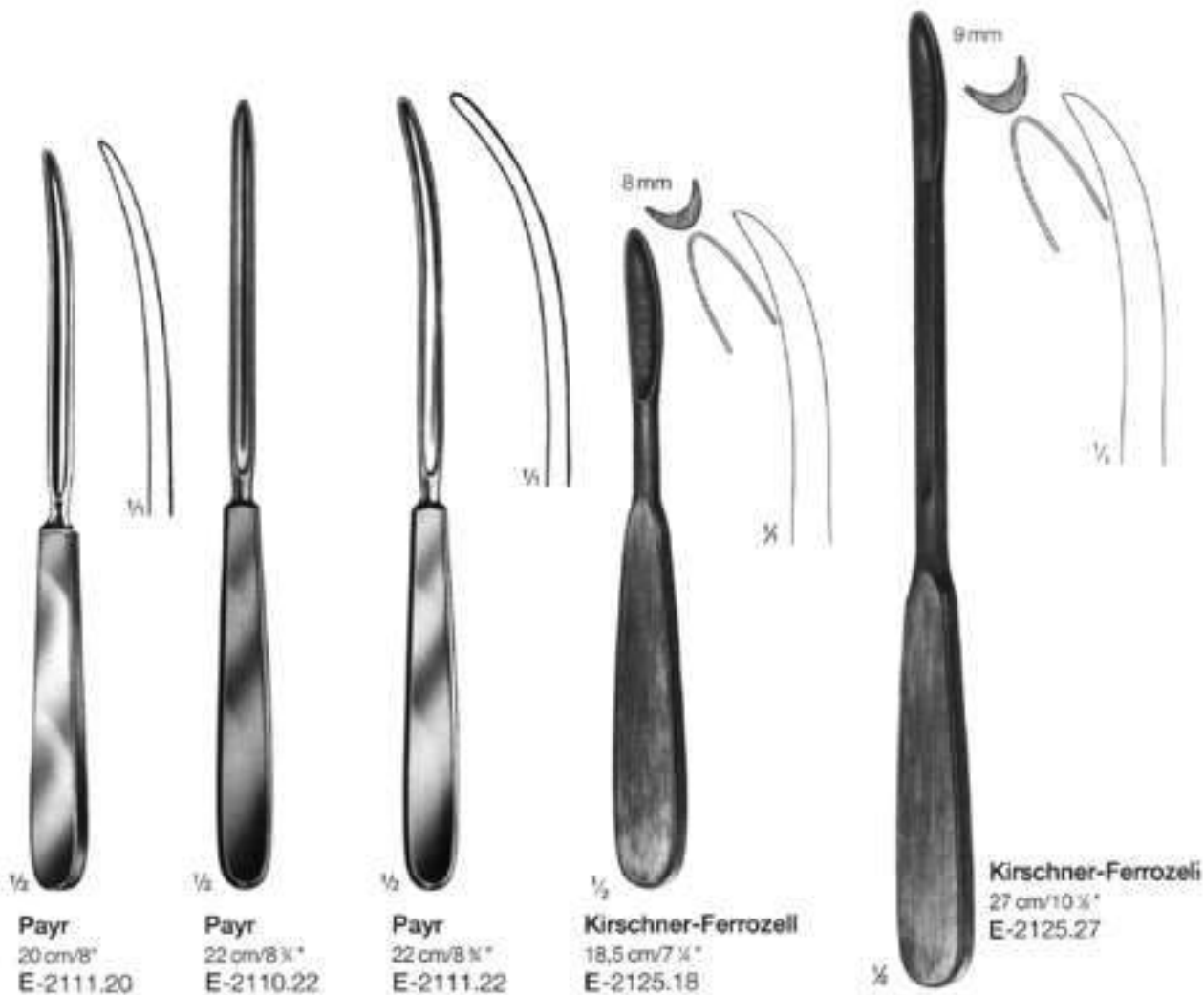



FRIEDRICH
16,5 cm/6¹/₄"
E-2580.16



MODELL WIEN
23,5 cm/9¹/₄"
E-2550.23



BOZEMANN
21 cm/8¹/₄"
E-2550.21



21 cm/8"
E-2570.23

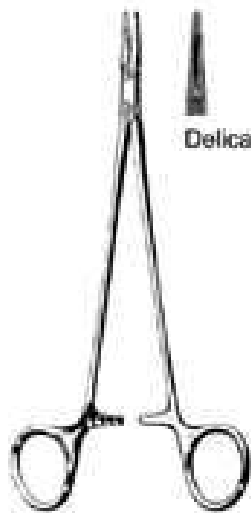

MAYO.HEGAR
E-2540.16 16 cm/6¹/₄"
E-2540.18 18 cm/7"
E-2540.20 20 cm/8"

Delicate

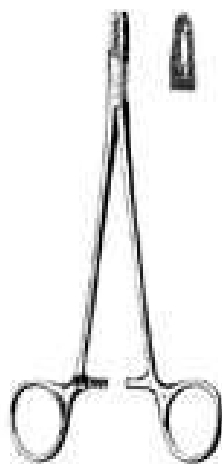

ADSON
E-2548.18
18 cm/7"

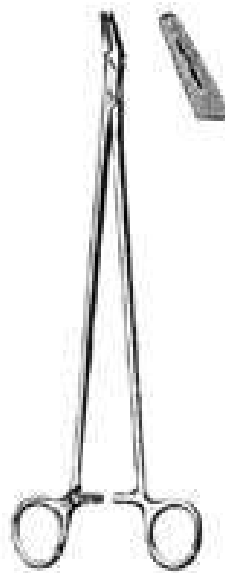

FINOCCHIETTO
E-4249.27
27 cm/10³/₄"

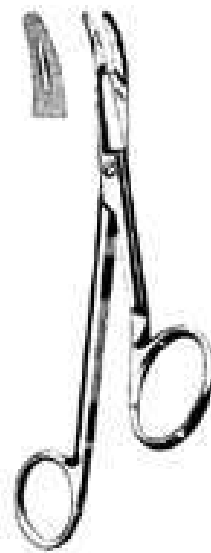

GILLIES
E-2290.18
18 cm/8¹/₂"

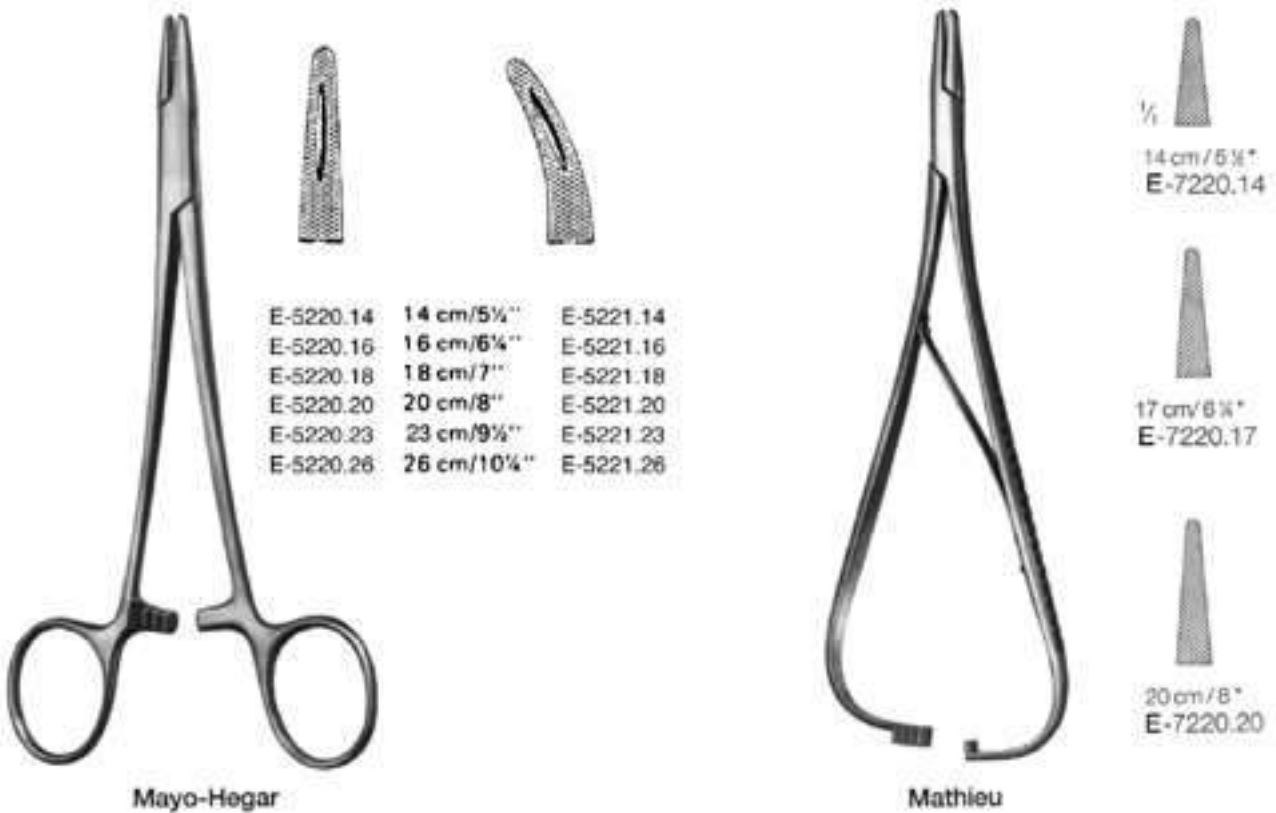
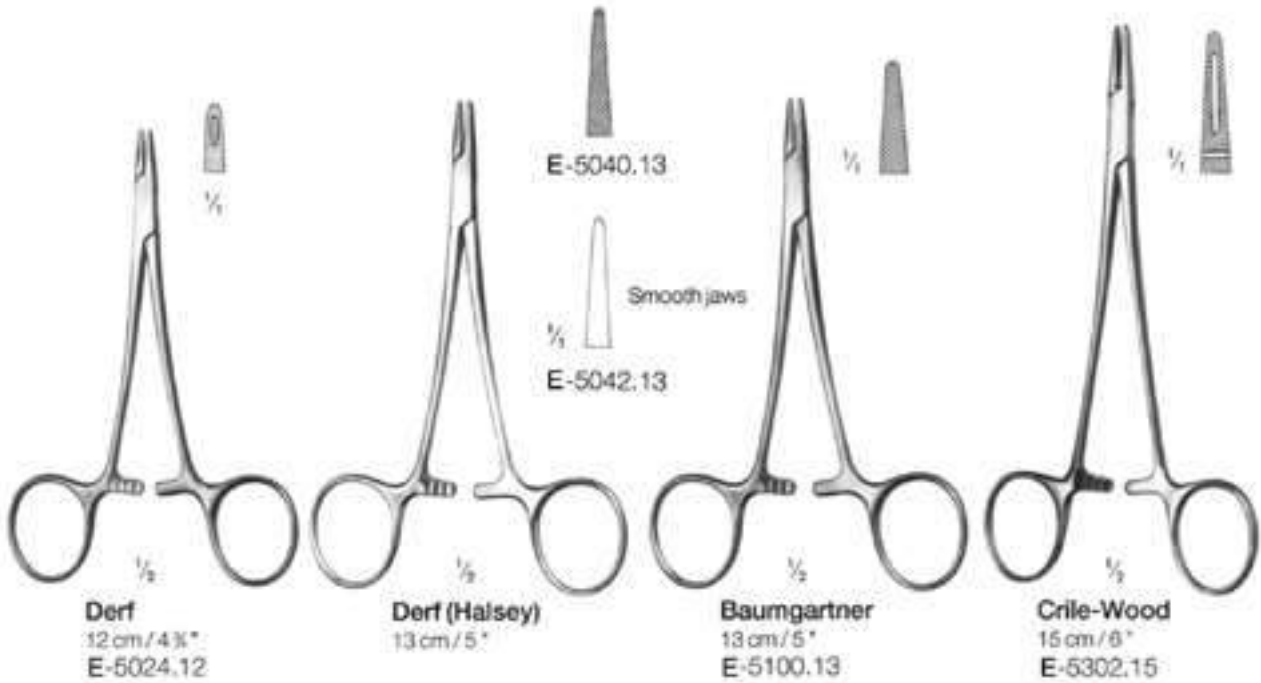



sizes mm	
7,5 x 1,75	E-9010.07
11,0 x 2	E-9010.11
12,0 x 3	E-9010.12
14,0 x 3	E-9010.14
16,0 x 3	E-9010.16
18,0 x 3	E-9010.18
20,0 x 3	E-9010.20
22,0 x 3	E-9010.22

Michel

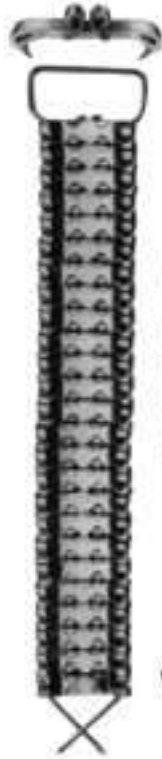

sizes mm	
12 x 3	E-9020.12
14 x 3	E-9020.14
16 x 3	E-9020.16
18 x 3	E-9020.18
20 x 3	E-9020.20

Wachenfeldt



Kölner Sparklammern
E-9050.10

for applying and removing



Michel
12 cm/4 3/4"
E-9060.12



Collin
13 cm/5"
E-9067.13

for removing



Richter-Heath
14 cm/5 1/2"
E-9089.14

Applying and Removing Forceps
for Scalp Hemostasis Clips



Raney
16 cm/6 1/4"
E-9112.16



Raney
E-9113.12
Scalp Hemostasis Clips



Silver Wire in coils

McKenzie 2.5g
E-9200.25



McKenzie
18 cm/7"
E-9200.18

Clip Applying Forceps

Clip Bending and Cutting Forceps

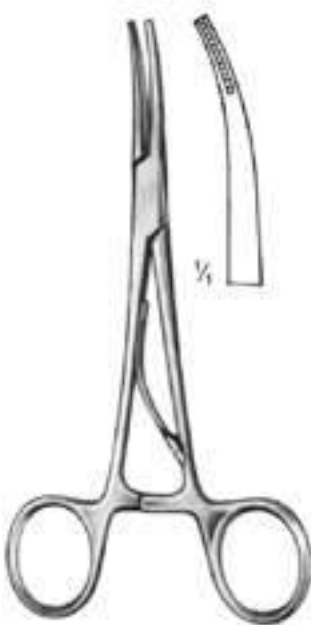

McKenzie
E-9201.15 = 15 cm/6"
E-9201.19 = 19 cm/7 1/2"

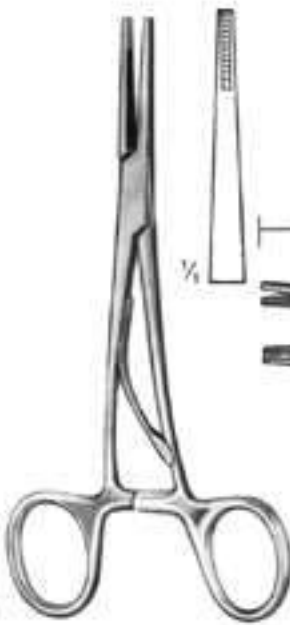

McKenzie
E-9203.15 = 15 cm/6"
E-9203.19 = 19 cm/7 1/2"

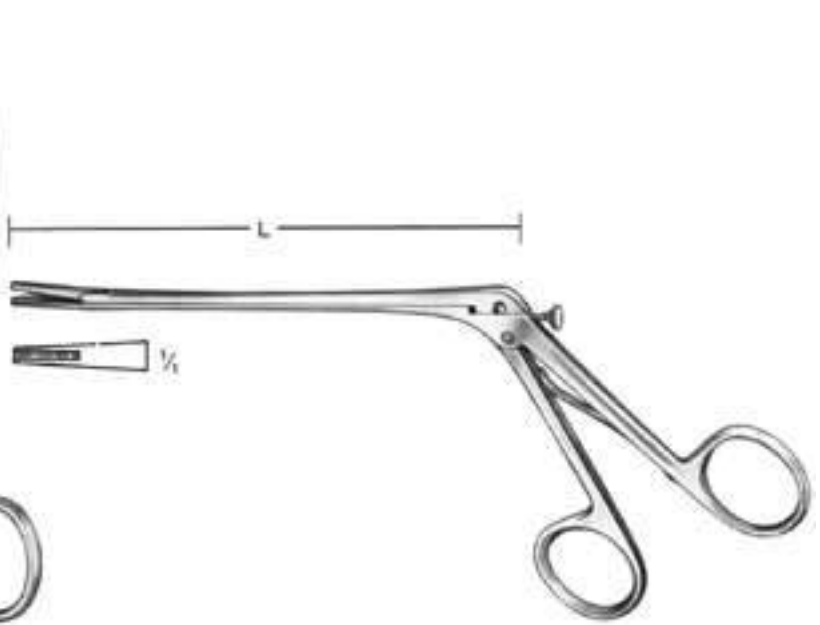

Olivecrona-Toennis (Scoville)
L = 14 cm/5 1/2" = E-9212.14
L = 21 cm/8 1/4" = E-9212.21

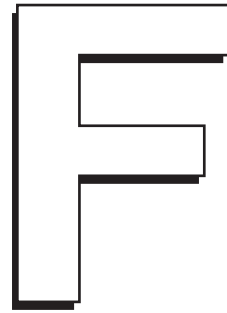

- Scissors
- Ciseaux
- Tijeras

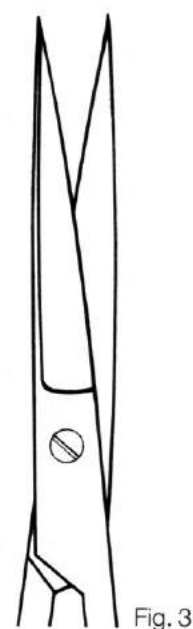
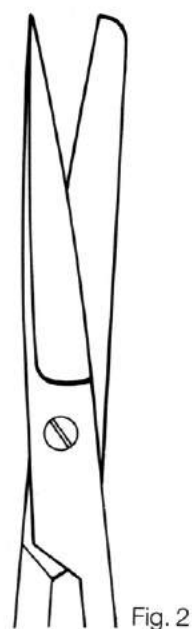
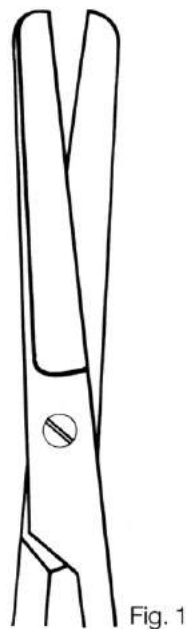

cm	inch.			
11,5	4 ½	F-0110.11	F-0120.11	F-0130.11
13	5	F-0110.13	F-0120.13	F-0130.13
14,5	5 ¾	F-0110.14	F-0120.14	F-0130.14
16,5	6 ½	F-0110.16	F-0120.16	F-0130.16
18,5	7 ¼	F-0110.18	F-0120.18	F-0130.18

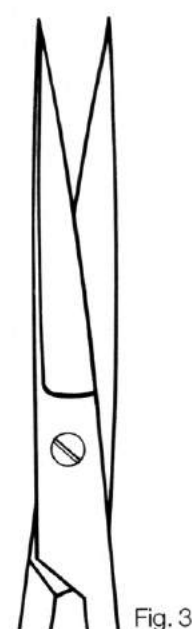
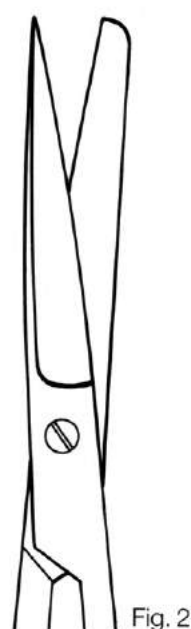
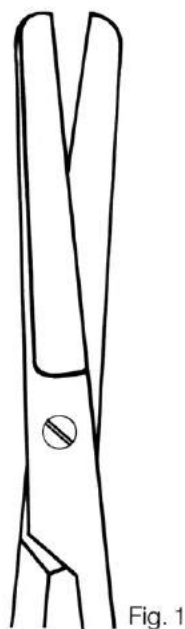
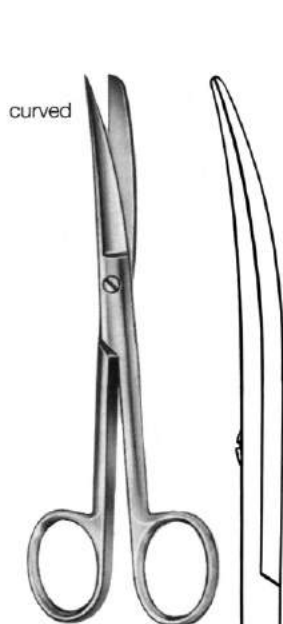

cm	inch.			
11,5	4 ½	F-0111.11	F-0121.11	F-0131.11
13	5	F-0111.13	F-0121.13	F-0131.13
14,5	5 ¾	F-0111.14	F-0121.14	F-0131.14
16,5	6 ½	F-0111.16	F-0121.16	F-0131.16
18,5	7 ¼	F-0111.18	F-0121.18	F-0131.18

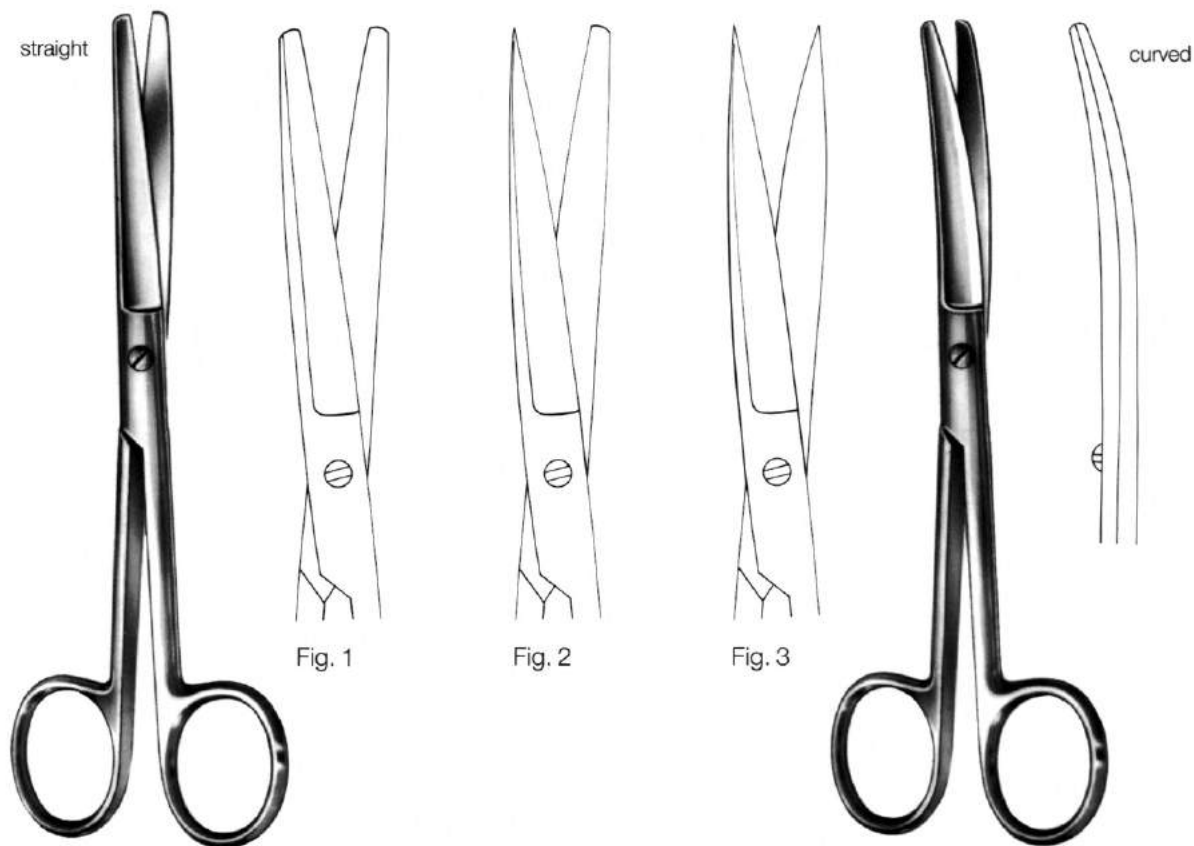

Grazil
 02-0141.##

	cm	inch.	
Fig. 1	13	5	F-0141.13
	14,5	5 7/8	F-0141.14
Fig. 2	13	5	F-0142.13
	14,5	5 7/8	F-0142.14
Fig.3	13	5	F-0143.13
	14,5	5 7/8	F-0143.14

Grazil
 F-0151.##

	cm	inch.	
Fig. 1	13	5	F-0151.13
	14,5	5 7/8	F-0151.14
Fig. 2	13	5	F-0152.13
	14,5	5 7/8	F-0152.14
Fig.3	13	5	F-0153.13
	14,5	5 7/8	F-0153.14

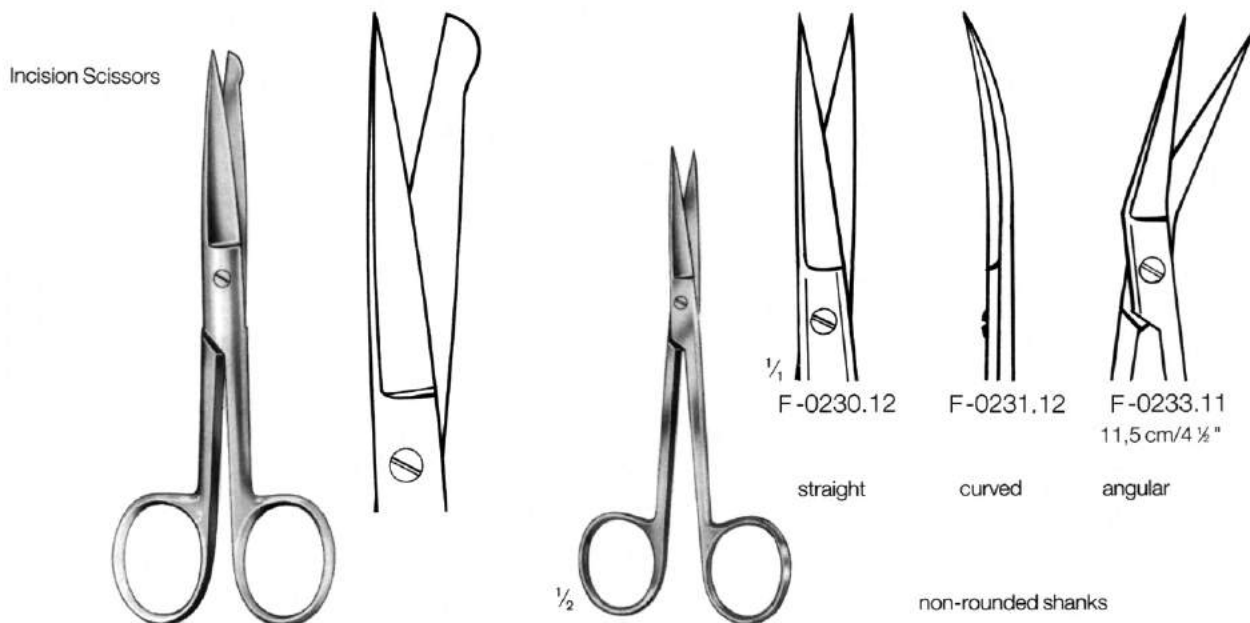
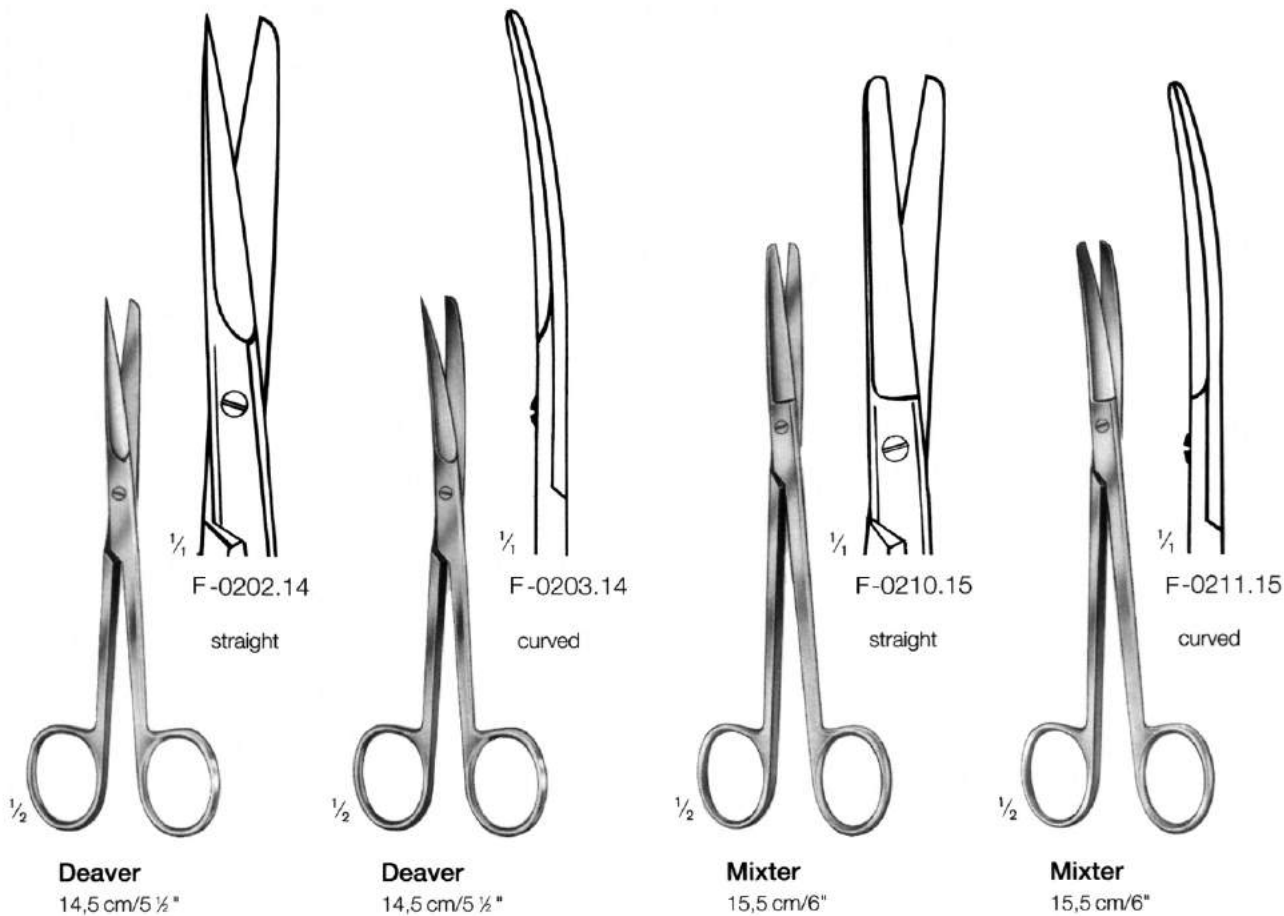

F-0220.##		
cm	inch.	
13,0	5	F-0220.13
14,5	5 1/2	F-0220.14
15,3	6	F-0220.15

Iris
12,5 cm/4 3/4"

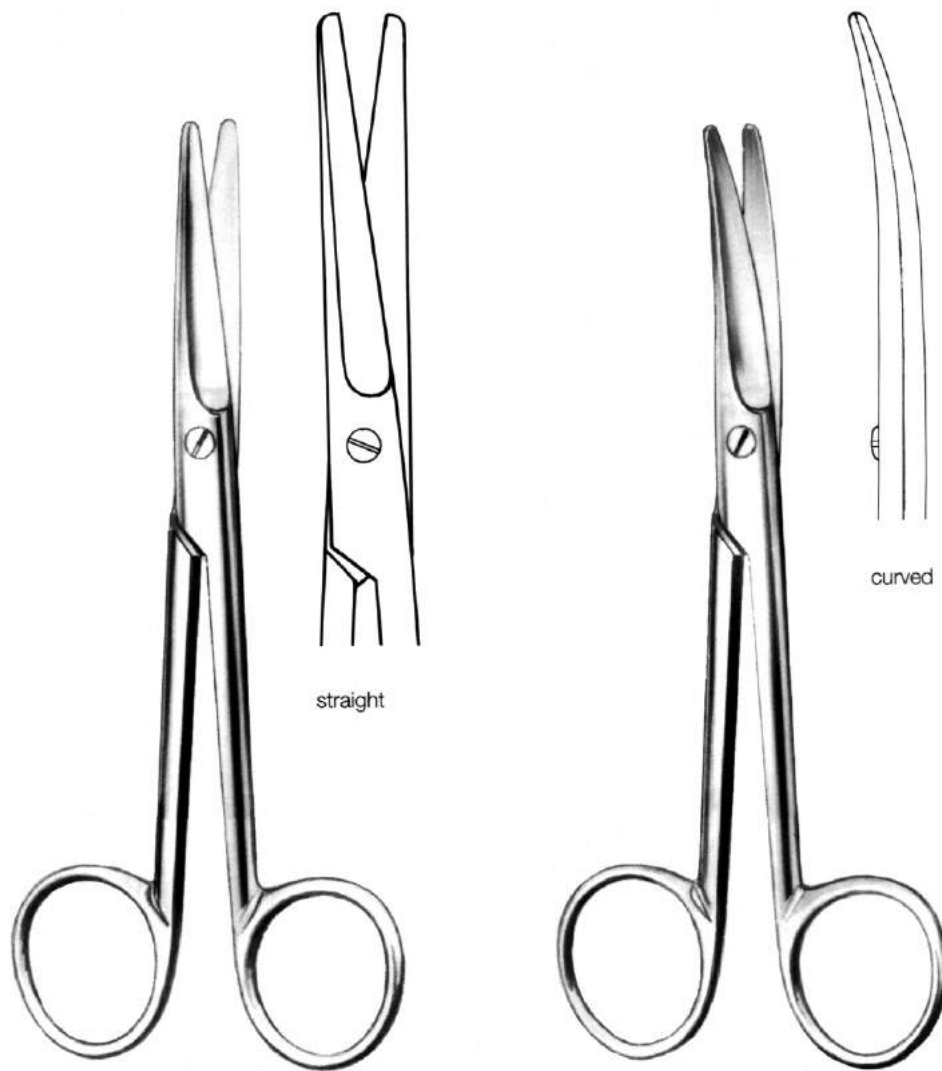

Mayo

Mayo

cm	inch.		
14	5½	F-0310.14	F-0311.14
15,5	6	F-0310.15	F-0311.15
17	6¾	F-0310.17	F-0311.17
21	8¼	F-0310.21	F-0311.21
23	9	F-0310.23	F-0311.23

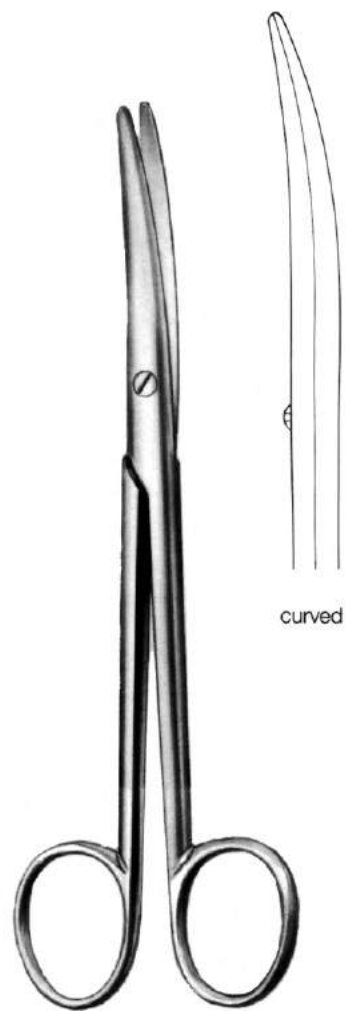
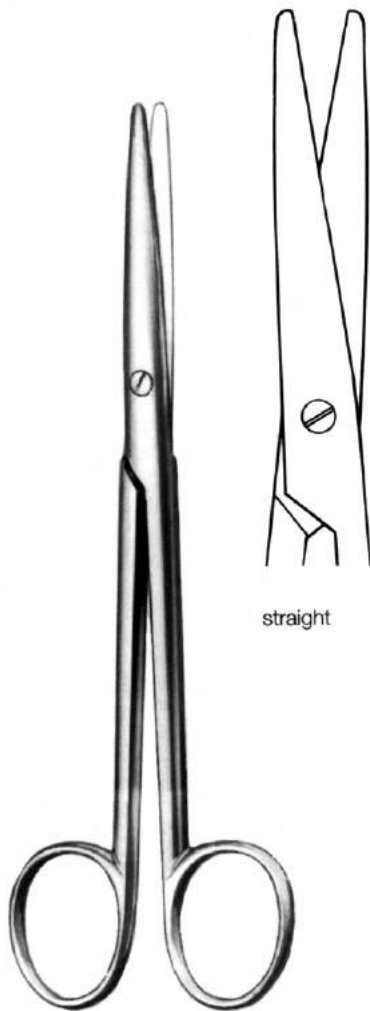

Mayo-Stille

F-0320.15
 F-0320.17

cm	inch.
15	6
17	6 ¾

Mayo-Stille

F-0321.15
 F-0321.17

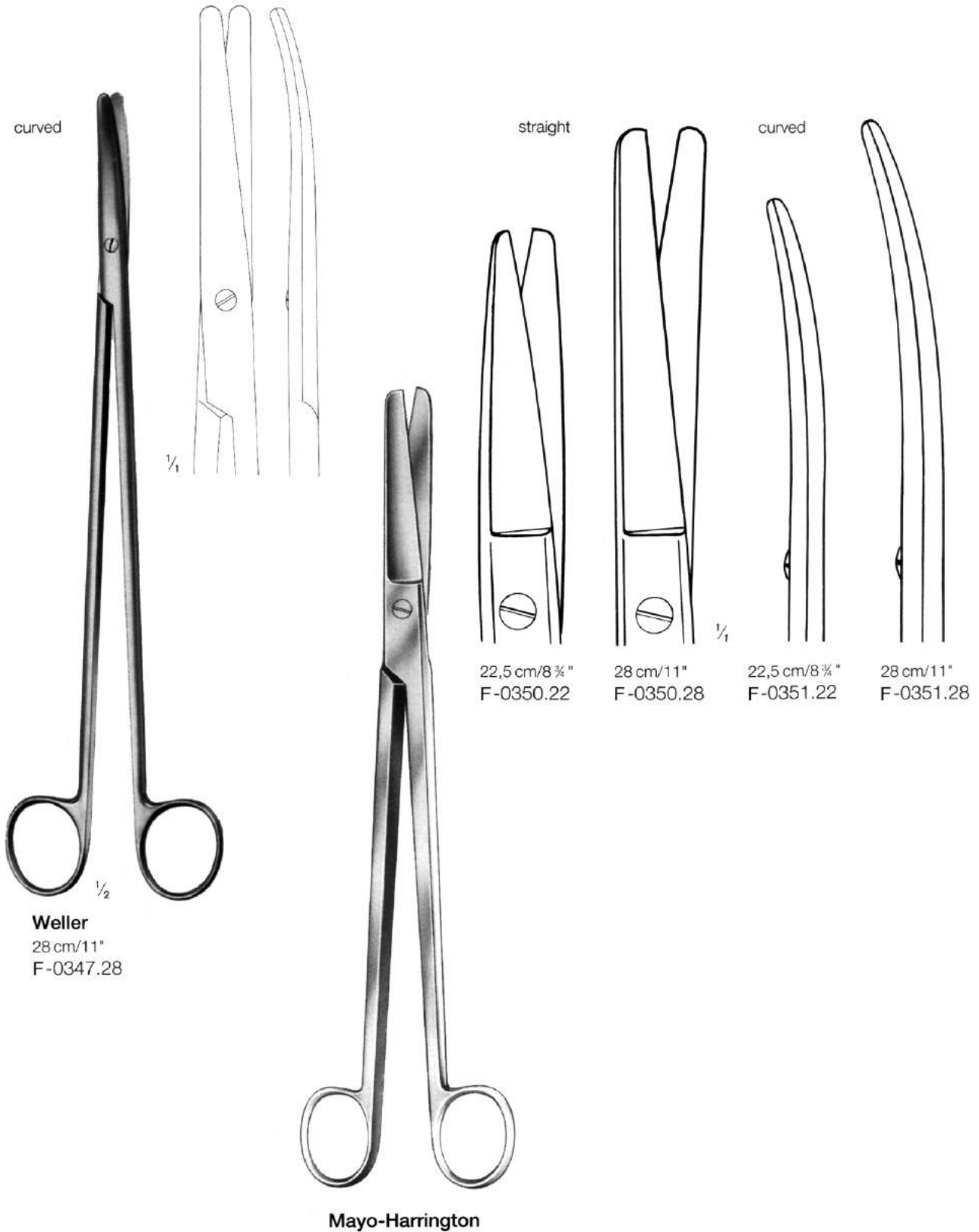

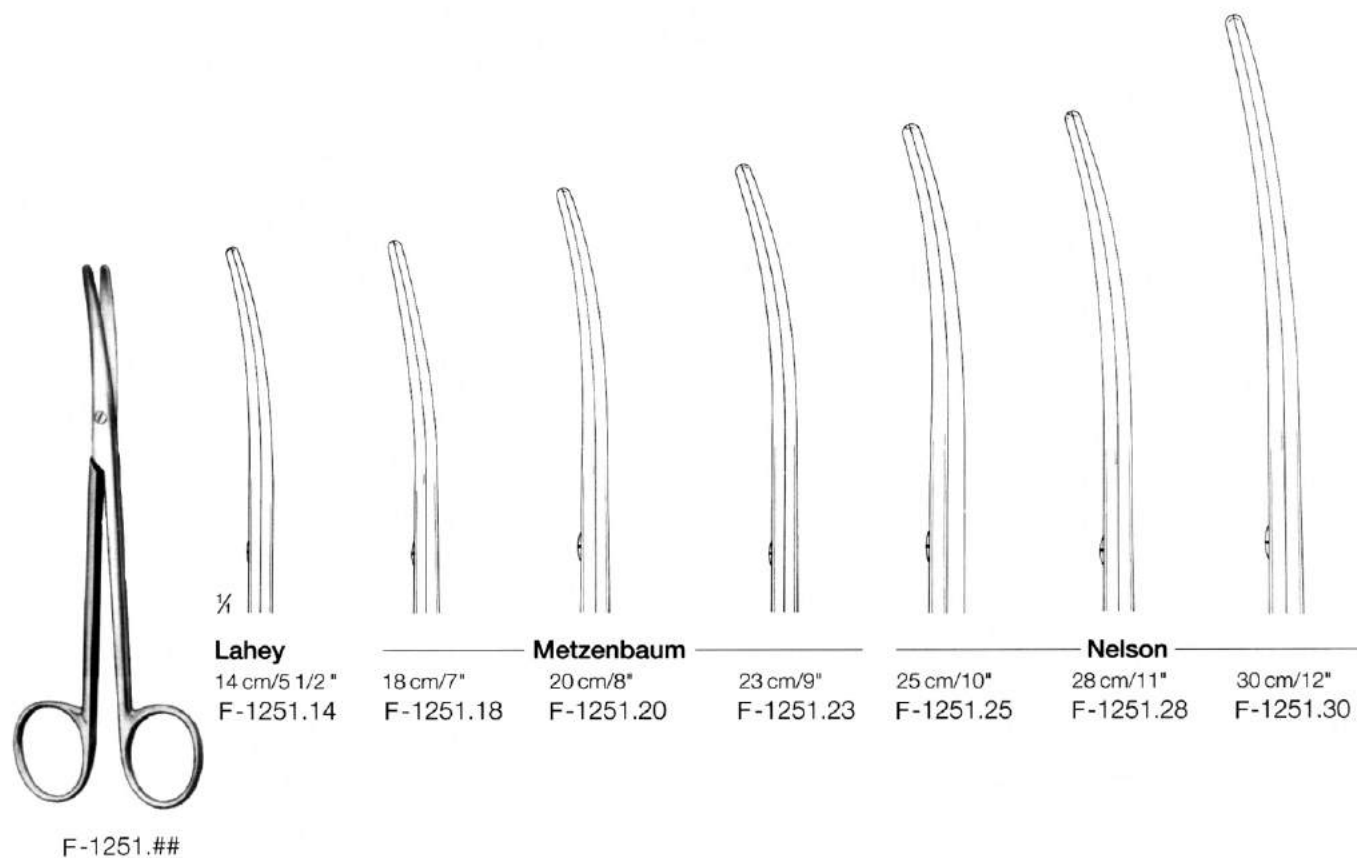
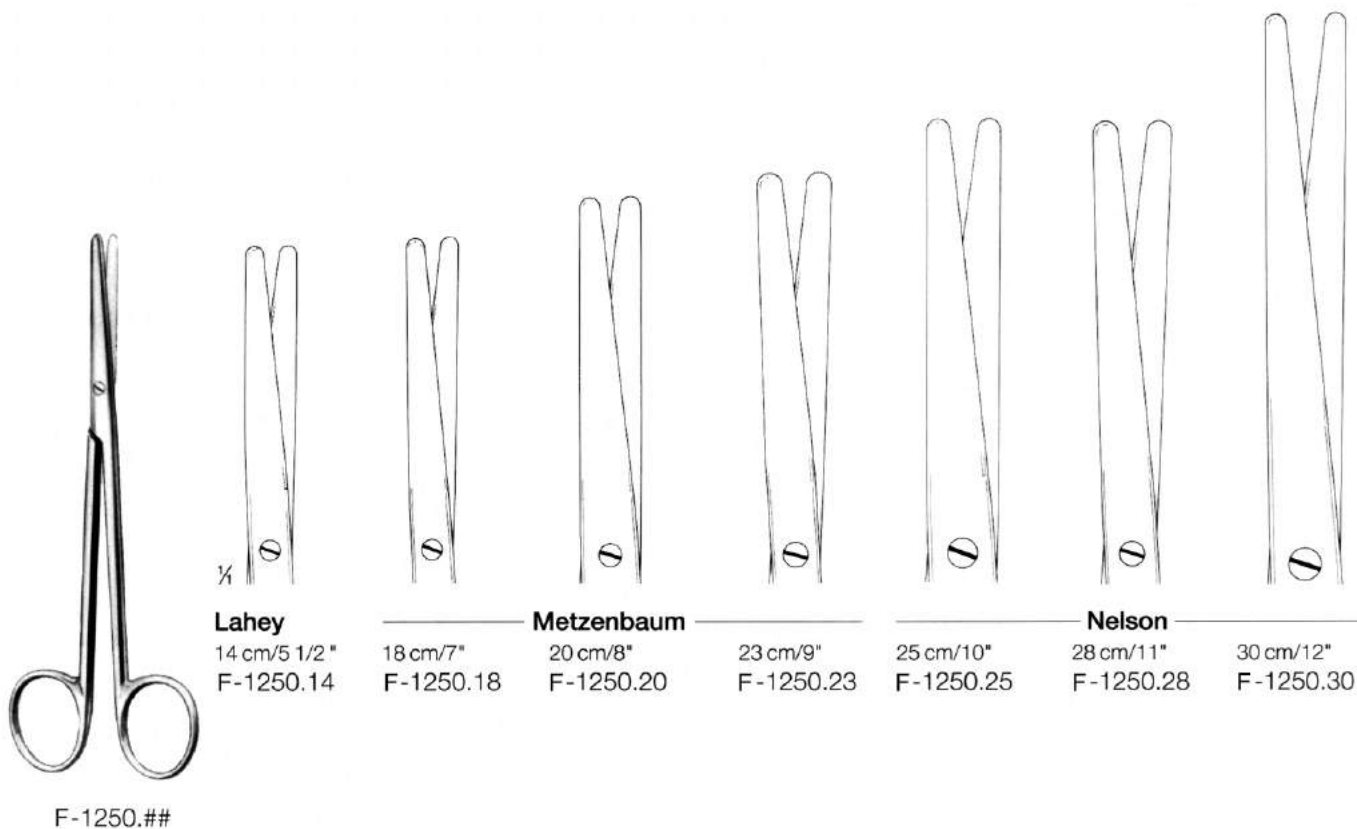



Mayo-Lexer

straight

curved

cm inch.

16	6 ¼	F-0330.16	F-0331.16
21	8 ¼	F-0330.21	F-0331.21

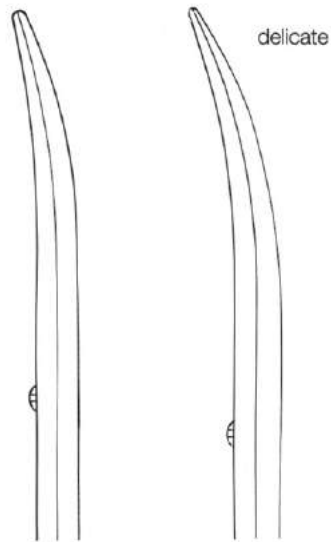

Lexer fino
16,5 cm/6 ½"

curved

F-0333.16

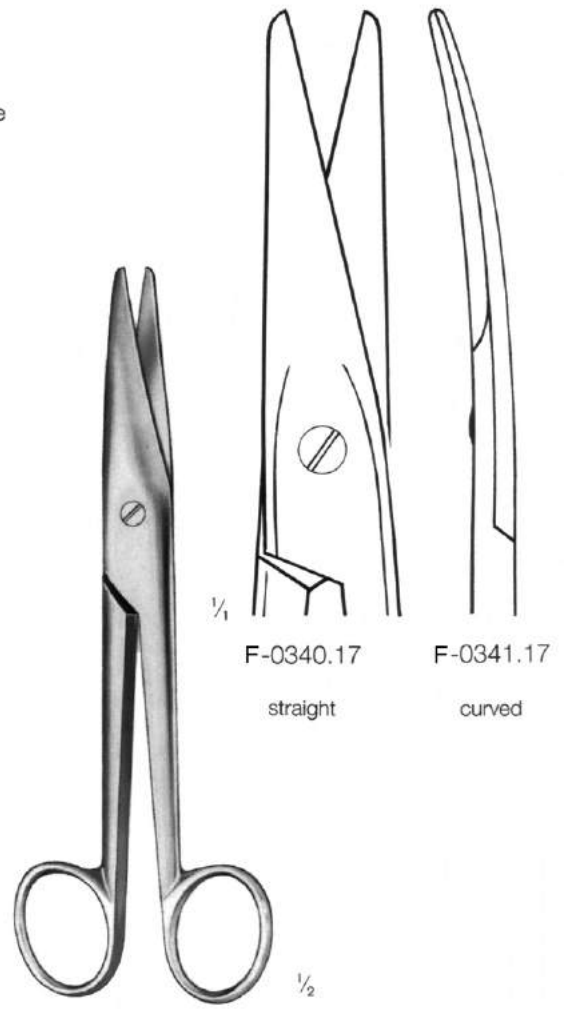

Mayo-Noble
17 cm/6 ¾"

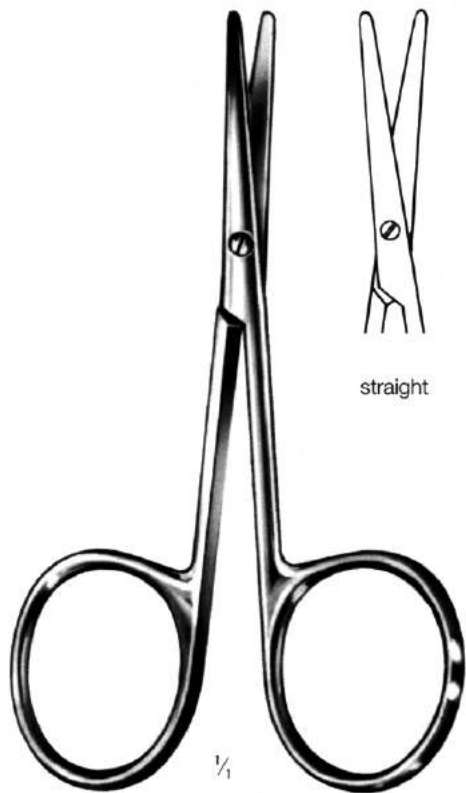

Lexer-Baby
 10,5 cm/4"
 F-1010.10

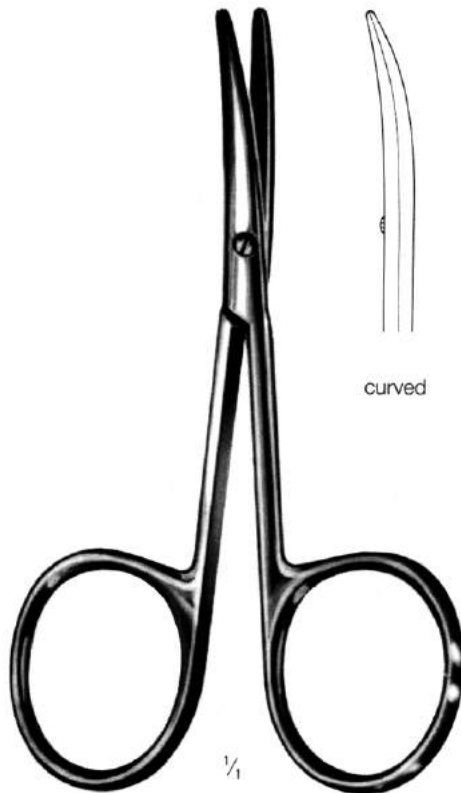

Lexer-Baby
 10,5 cm/4"
 F-1011.10



Stevens
 11,5 cm/4 1/2"

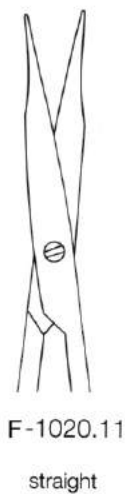

F-1020.11

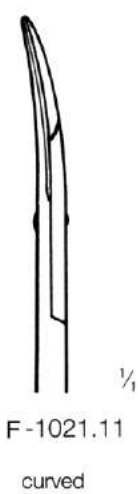

F-1021.11

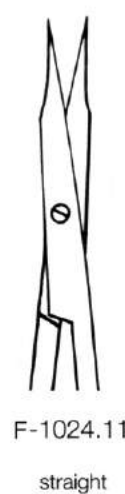

F-1024.11



F-1025.11

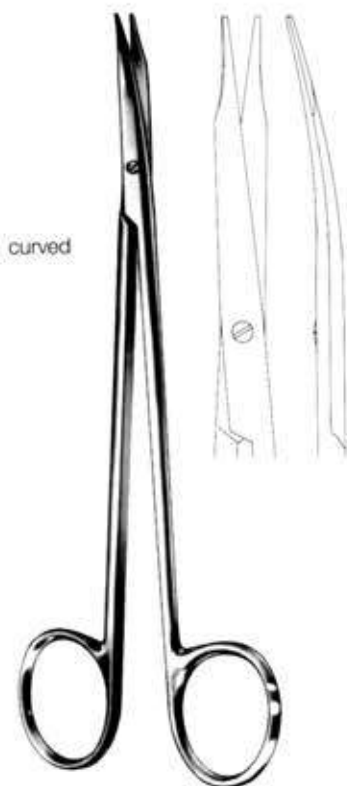

Reynolds

cm	inch.	
13,5	5 1/4	F-1041.13
15,0	6	F-1041.15
18,0	7	F-1041.18
20,0	8	F-1041.20
23,0	9	F-1041.23



Jamison

15,5 cm/6*
 F-1045.15



15 cm/6*
 F-1049.15

Super Cut



Reynolds

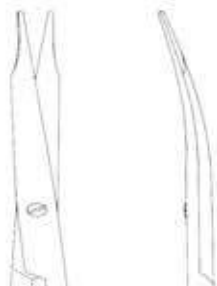

Straight

Curved

15 cm / 6 " F-3200-15 F-3201-15

18 cm / 7 " F-3200-18 F-3201-18

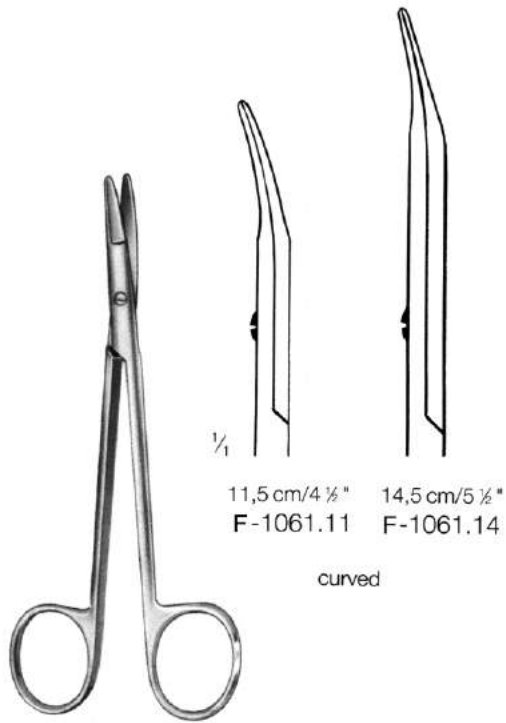

11,5 cm/4 1/2" F-1061.11
 14,5 cm/5 1/2" F-1061.14

curved

Kilner

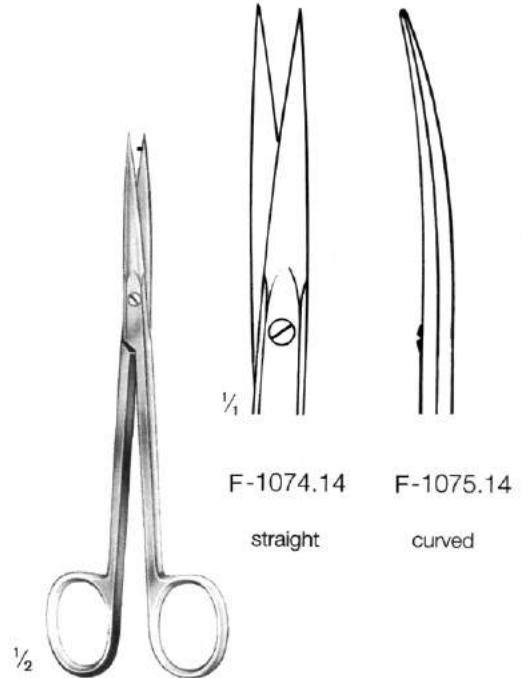

F-1074.14 F-1075.14

straight

curved

Brophy (Sullivan)

14,5 cm/5 1/2"

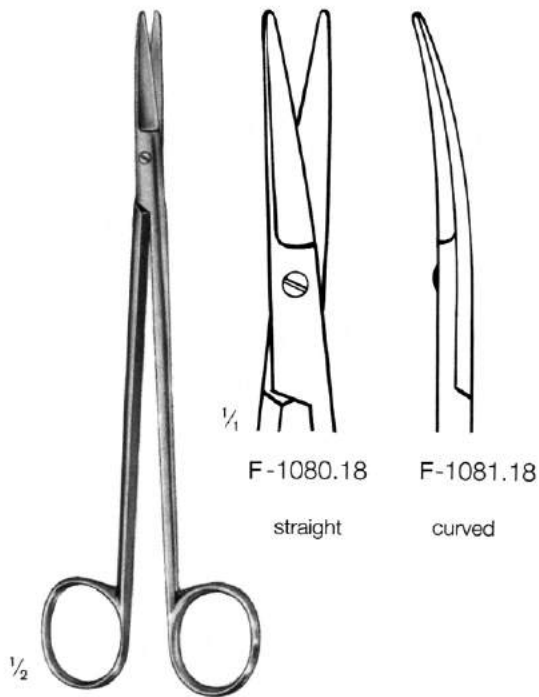

F-1080.18 F-1081.18

straight

curved

Tönnis (House)

18 cm/7"

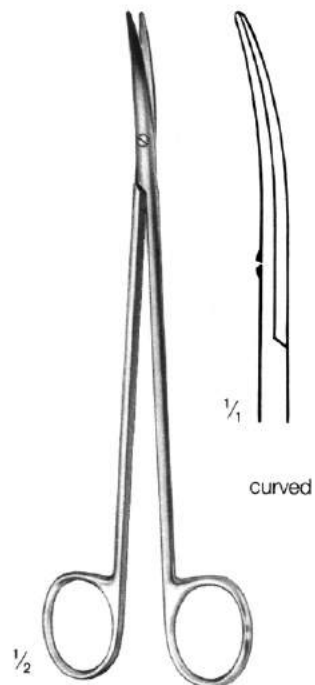

curved

Tönnis-Adson

17,5 cm/7"

F-1085.18

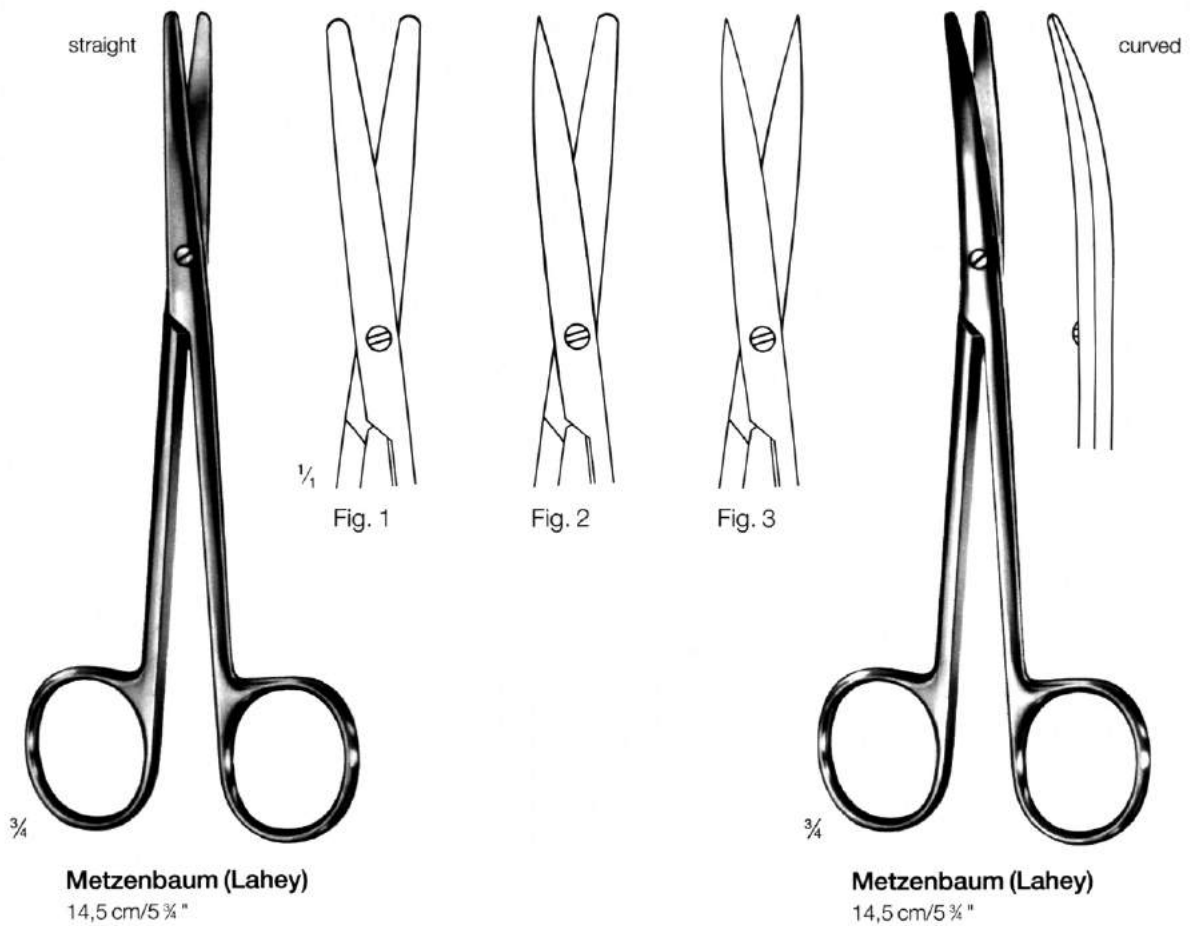

F-1210.14	Fig. 1	F-1211.14
F-1220.14	Fig. 2	F-1221.14
F-1230.14	Fig. 3	F-1231.14

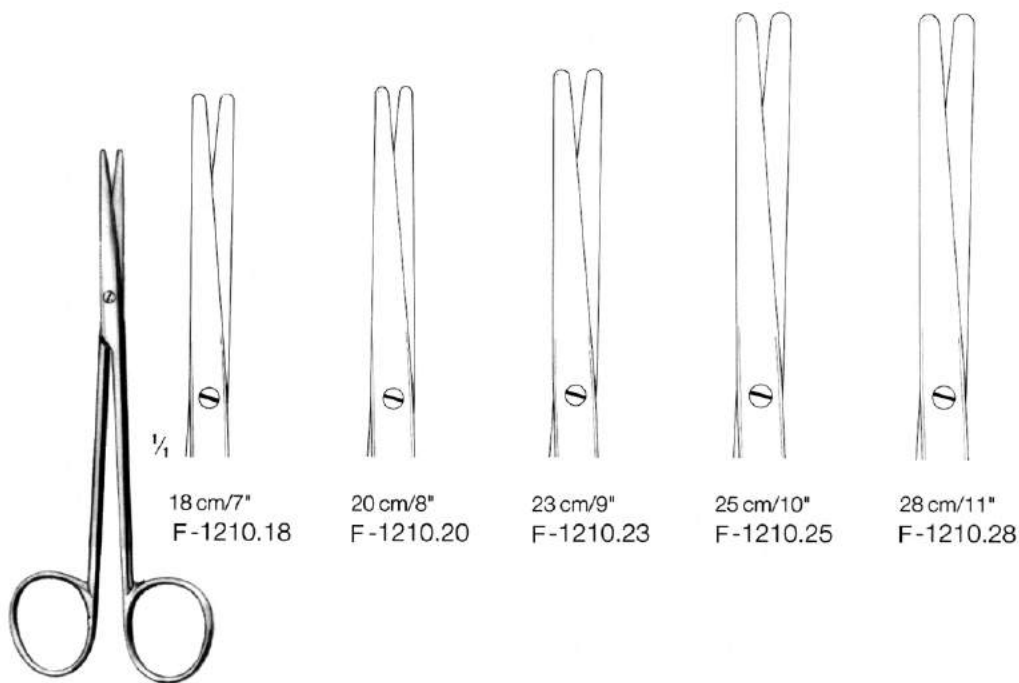

18 cm/7"
F-1210.18

20 cm/8"
F-1210.20

23 cm/9"
F-1210.23

25 cm/10"
F-1210.25

28 cm/11"
F-1210.28

S-curved

Metzenbaum-Fino
F-1210.##

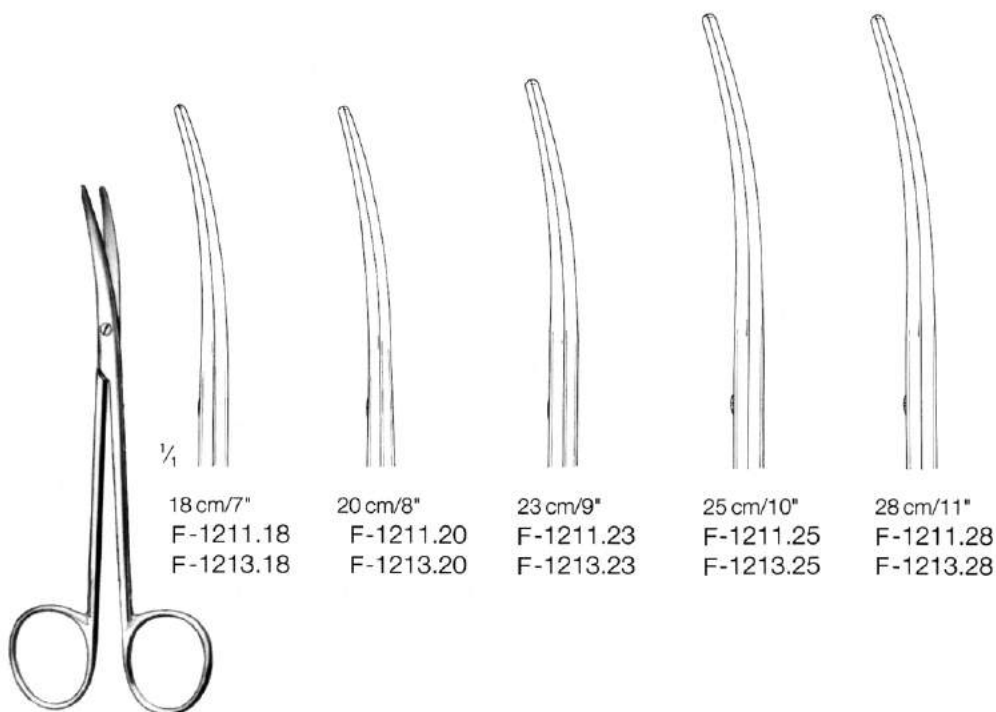

18 cm/7"
F-1211.18
F-1213.18

20 cm/8"
F-1211.20
F-1213.20

23 cm/9"
F-1211.23
F-1213.23

25 cm/10"
F-1211.25
F-1213.25

28 cm/11"
F-1211.28
F-1213.28

Metzenbaum-Fino
F-1211.##

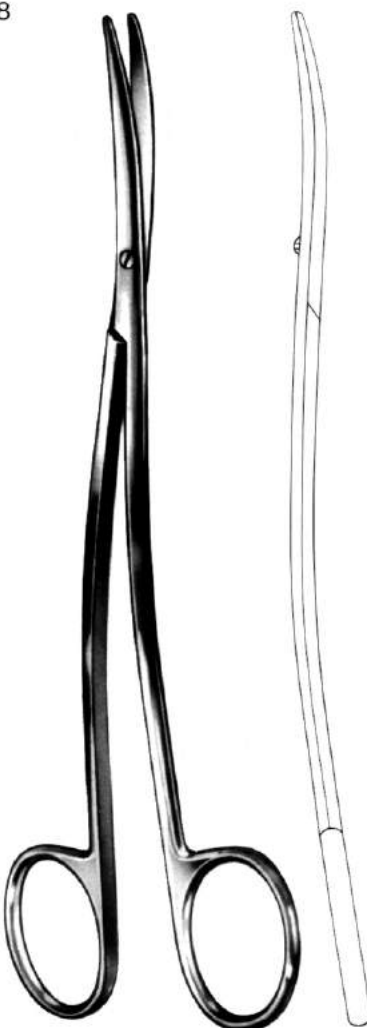

Metzenbaum-Fino
F-1213.##



Metzenbaum-Fino
 F-1230.##



18 cm/7"
 F-1230.18



20 cm/8"
 F-1230.20



23 cm/9"
 F-1230.23



Metzenbaum-Fino
 F-1231.##



18 cm/7"
 F-1231.18

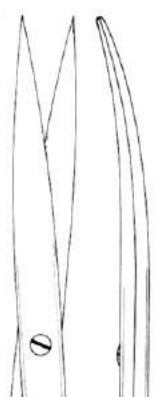

20 cm/8"
 F-1231.20



23 cm/9"
 F-1231.23



Finochietto
27 cm/10 3/4"
F-4021.27

Crafoord
30 cm/11 3/4"
F-4033.30

Willauer		
cm	inch.	
25	10	F-4045.25
28	11	F-4045.28

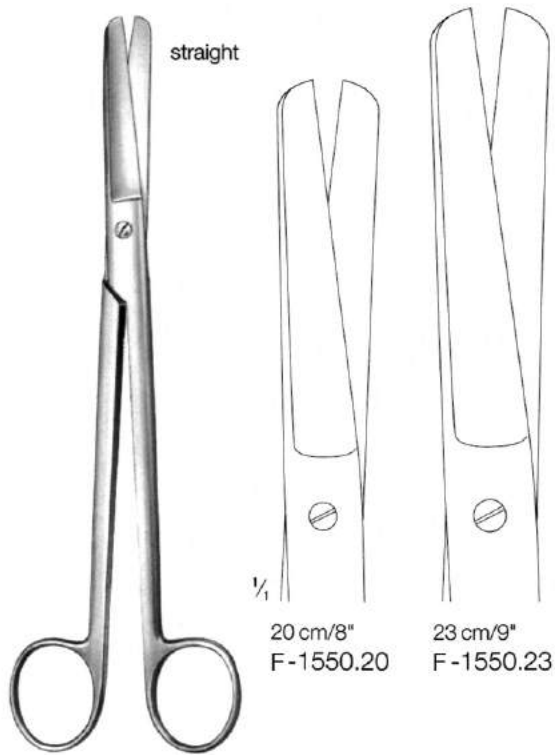

Sims
 F-1550.##

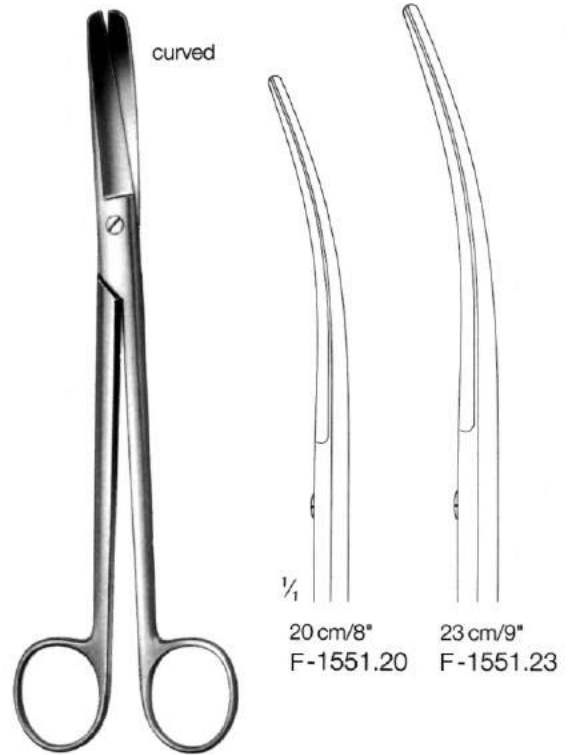

Sims
 F-1551.##

Abdominal Scissors,

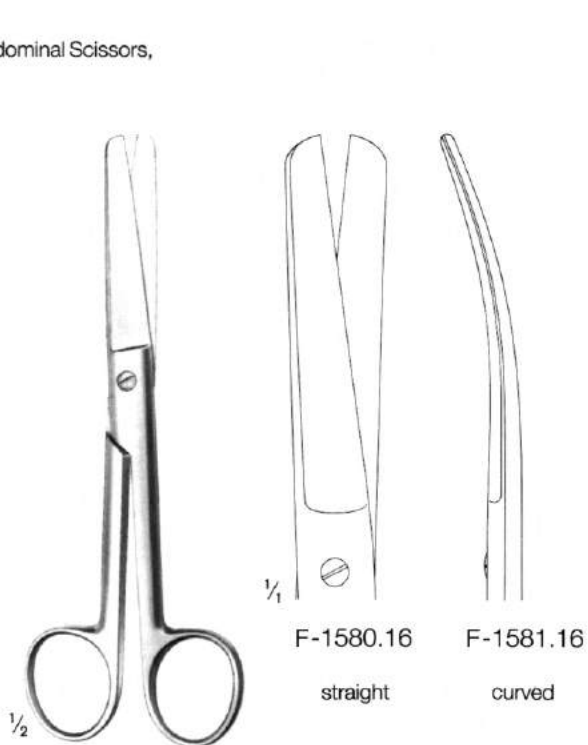

Doyen
 16 cm/6 1/4"

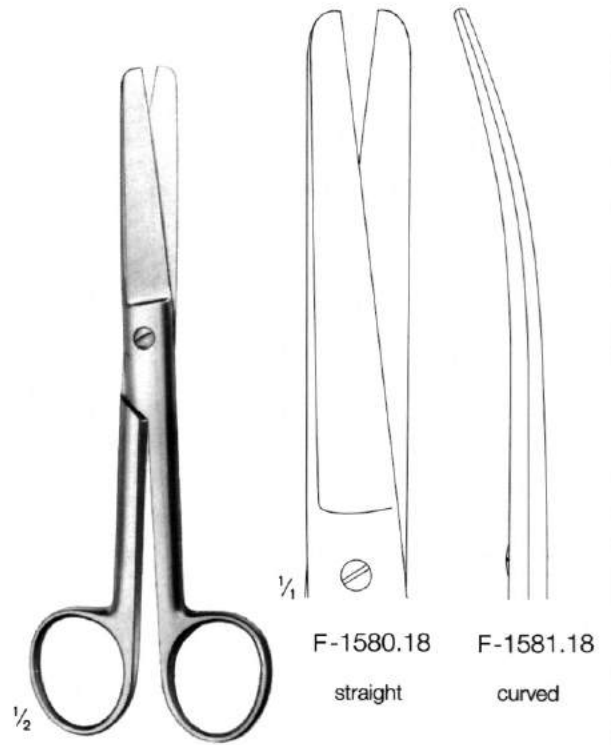

Doyen
 18 cm/7"

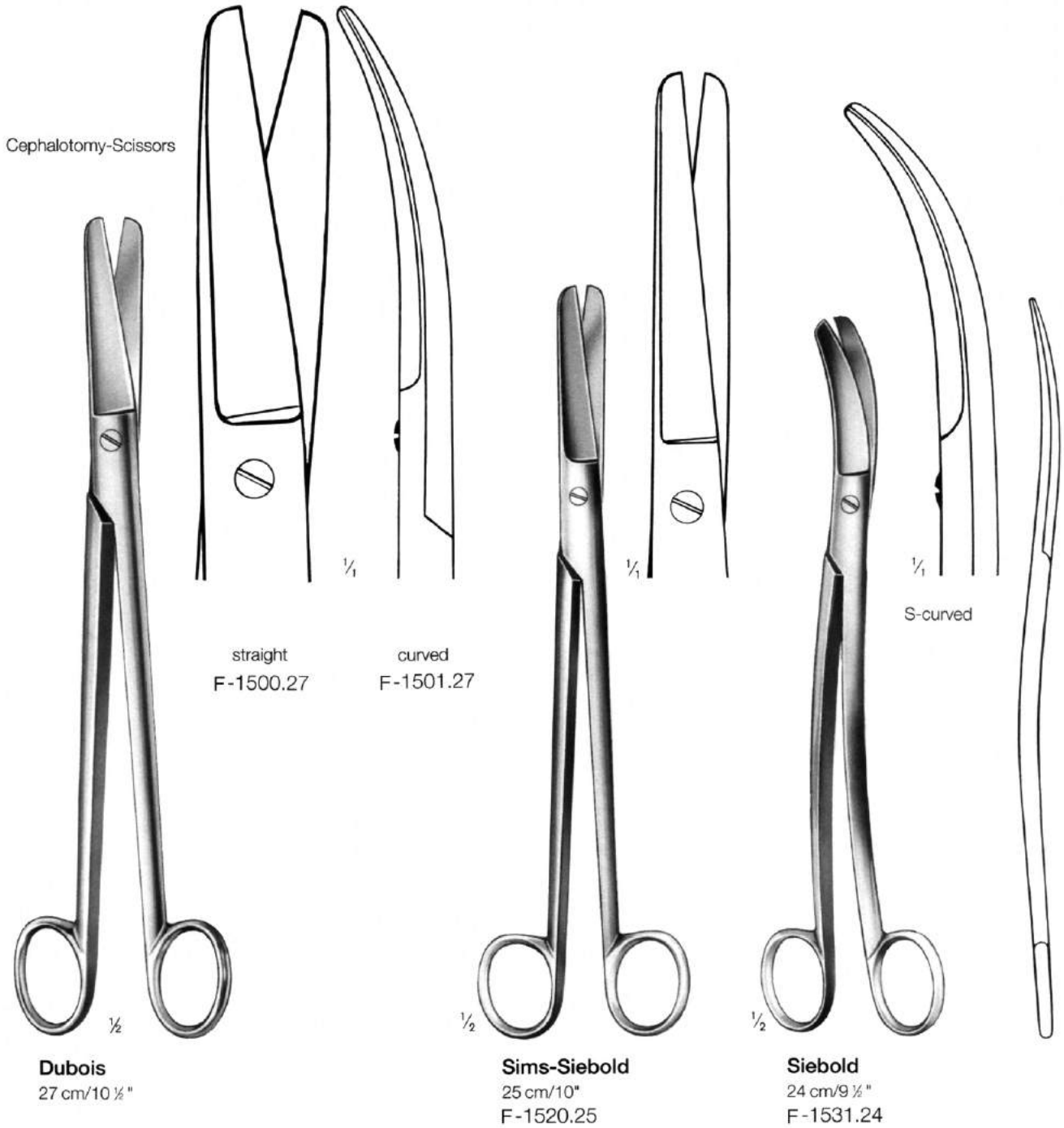



Braun-Stadler
 14 cm/5 1/2"
 F-1605.14



Braun-Stadler
 22 cm/8 3/4"
 F-1605.22

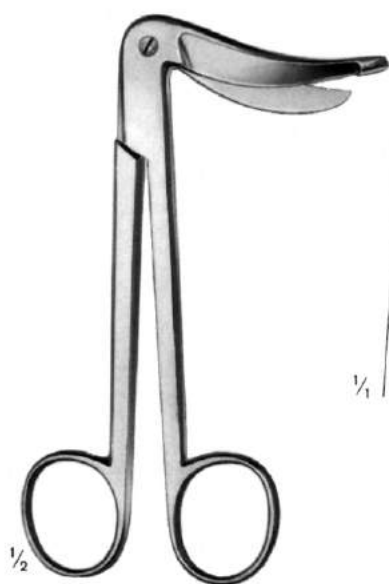
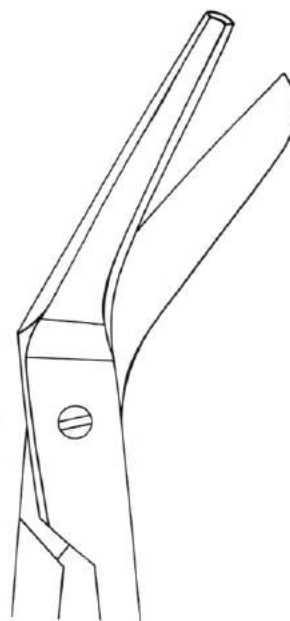

Marbach
 15,5 cm/6"
 F-1613.15

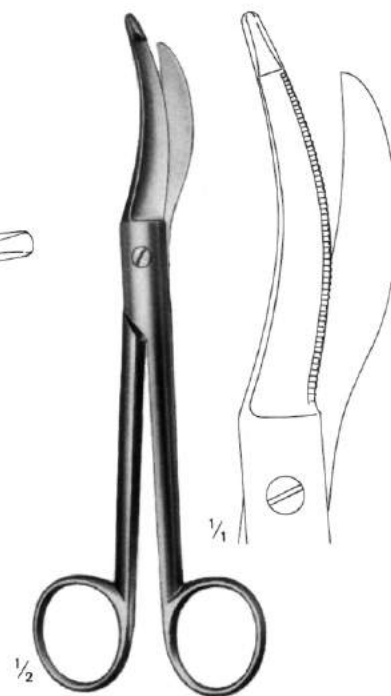
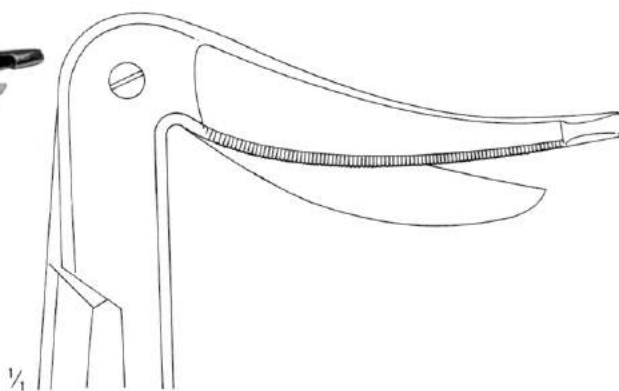

Waldmann
 18 cm/7"
 F-1617.18

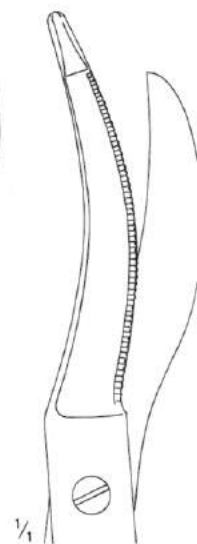

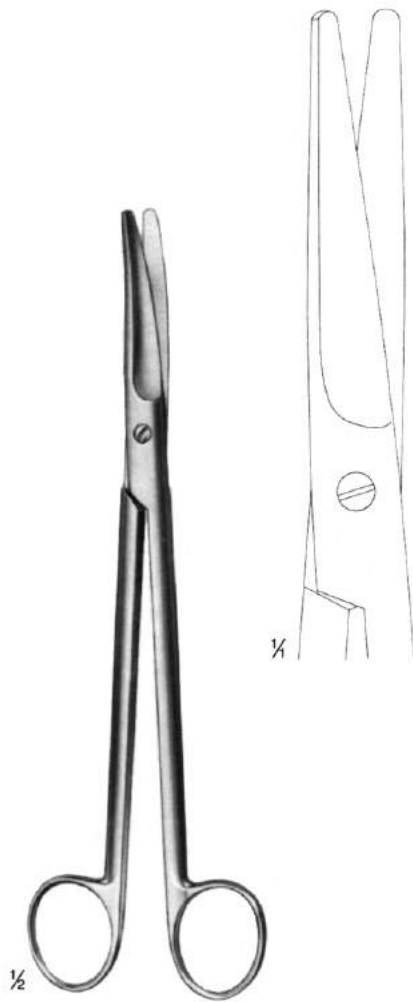

Parametrium

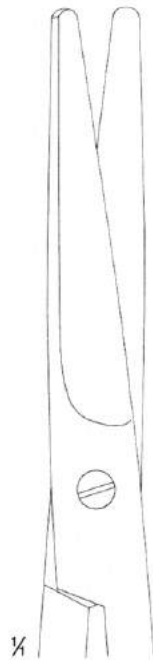

light curved



23 cm/9"
F-1625.23

strong curved

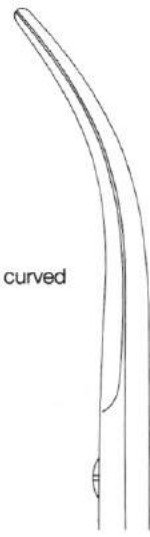

22 cm/8 1/2"
F-1625.22

Umbilical Cord Scissors

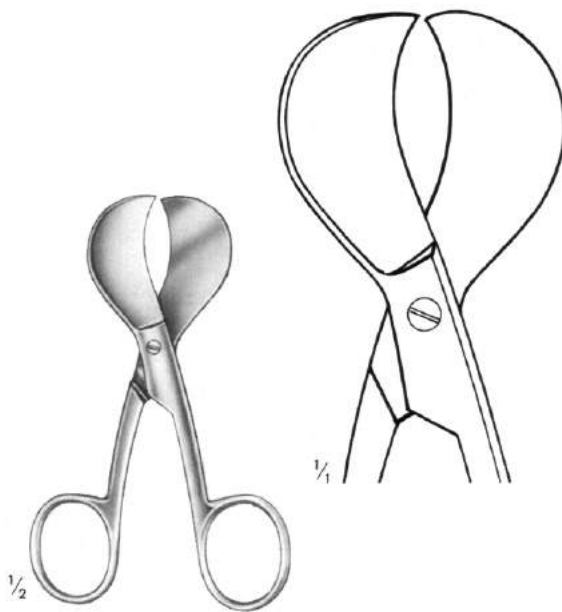

Mod. USA
 10,5 cm/4"
 F-1636.10

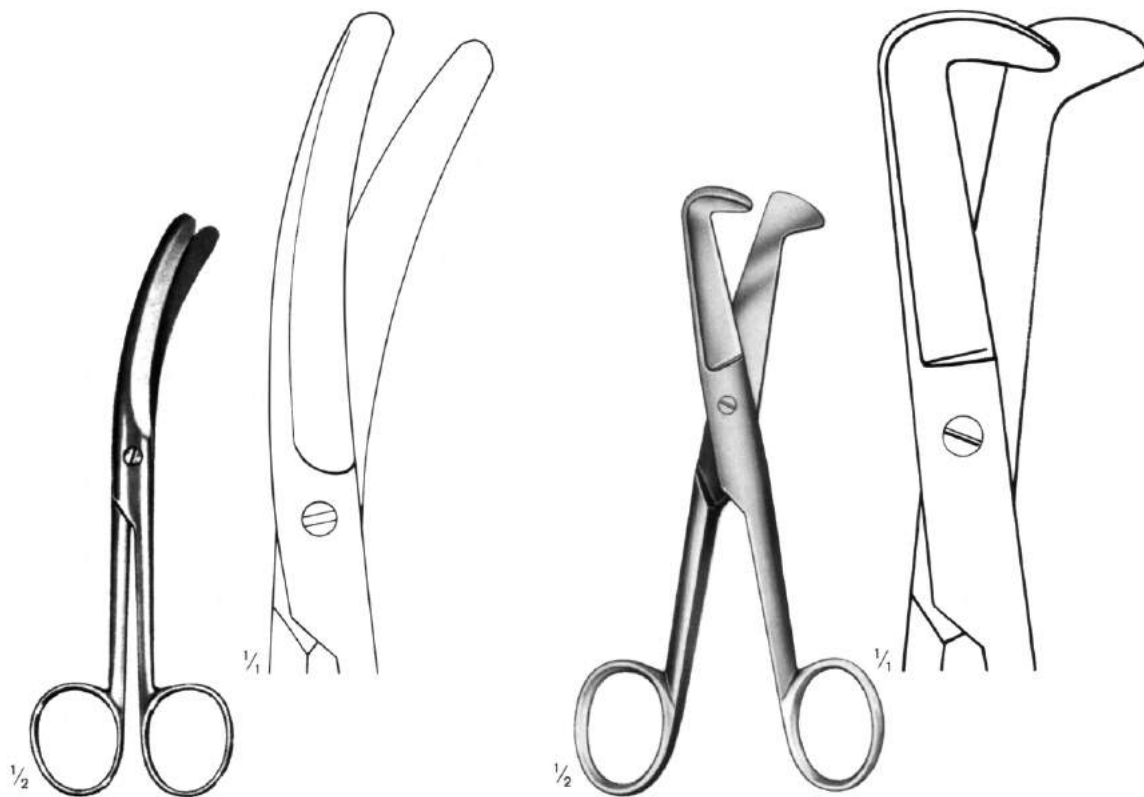

Busch
 16 cm/6 1/4"
 F-1641.16

Schumacher
 16 cm/6 1/4"
 F-1645.16

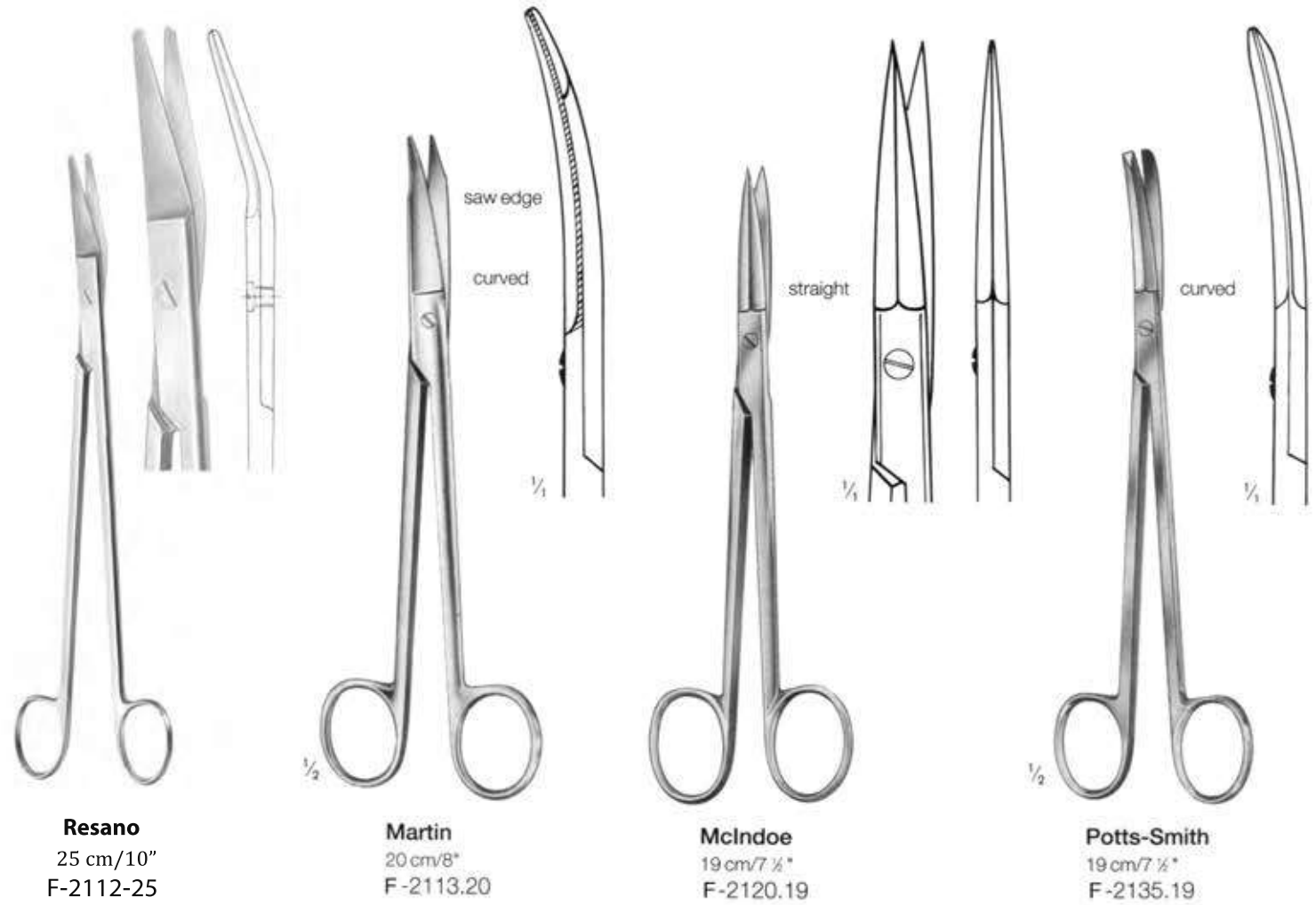

Wire Cutting scissors
Ciseaux pour couper les fils d'acier
Cizallas para cortar alambre

1 Blade serrated

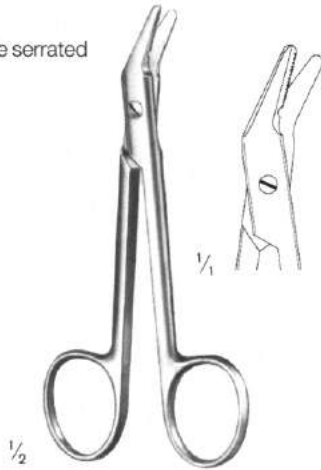

Universal
 12 cm/4 3/4"
 F-5101.12

saw edge



Harvey
 12,5 cm/5"
 F-5106.12

1 Blade serrated

straight



Schuknecht
 10 cm/4"
 F-5110.10

1 Blade serrated

straight



Smith
 17 cm/6 3/4"
 F-5116.17



1 Blade serrated

F-5130.12

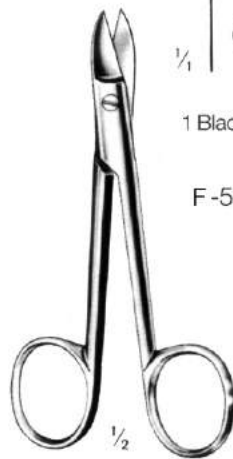

Beebee
 12 cm/4 3/4"
 F-5120.12

smooth

pointed



1 Blade serrated

F-5131.12

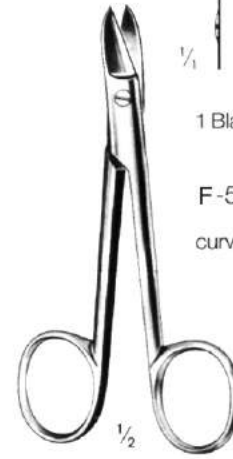

Beebee
 12 cm/4 3/4"
 F-5121.12

smooth



14,5 cm/5 $\frac{3}{4}$ "
F-5314.



17 cm/6 $\frac{3}{4}$ "
F-5317.



Universal
19 cm/7 $\frac{1}{2}$ "
F-5319.

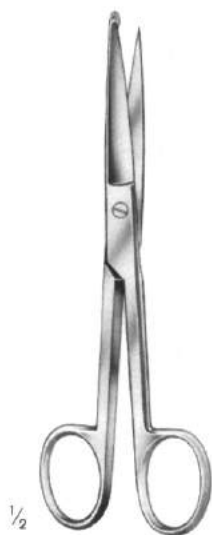

1/2

Knowles
 14,5 cm/5 1/2"
 F-5330.14



1/2

Knowles (Hi-Level)
 14 cm/5 1/2"
 F-5331.14

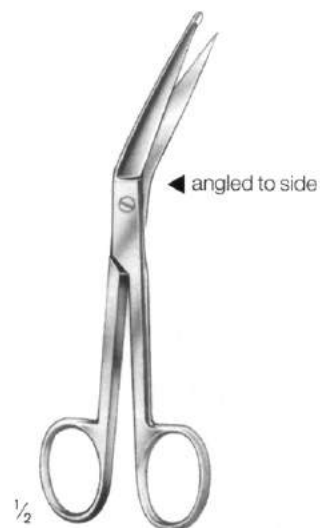

1/2

Knowles (Bantam)
 14 cm/5 1/2"
 F-5333.14

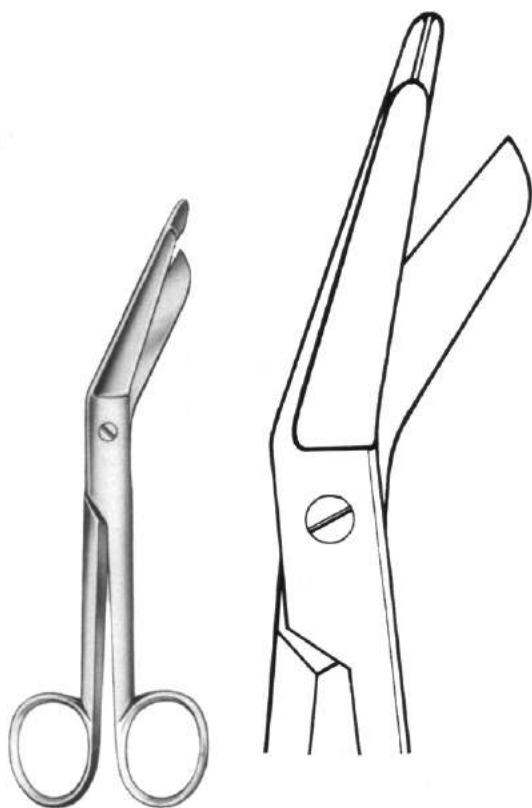

Lister

cm	inch.	
9	3 1/2	F-5353.09
11	4 1/2	F-5353.11
14	5 1/2	F-5353.14
18	7	F-5353.18
20	8	F-5353.20



Esmarch

cm	inch.	
20	8	F-5365.20
22	8 3/4	F-5365.22



Bergmann

23 cm/9"
 F-5369.23

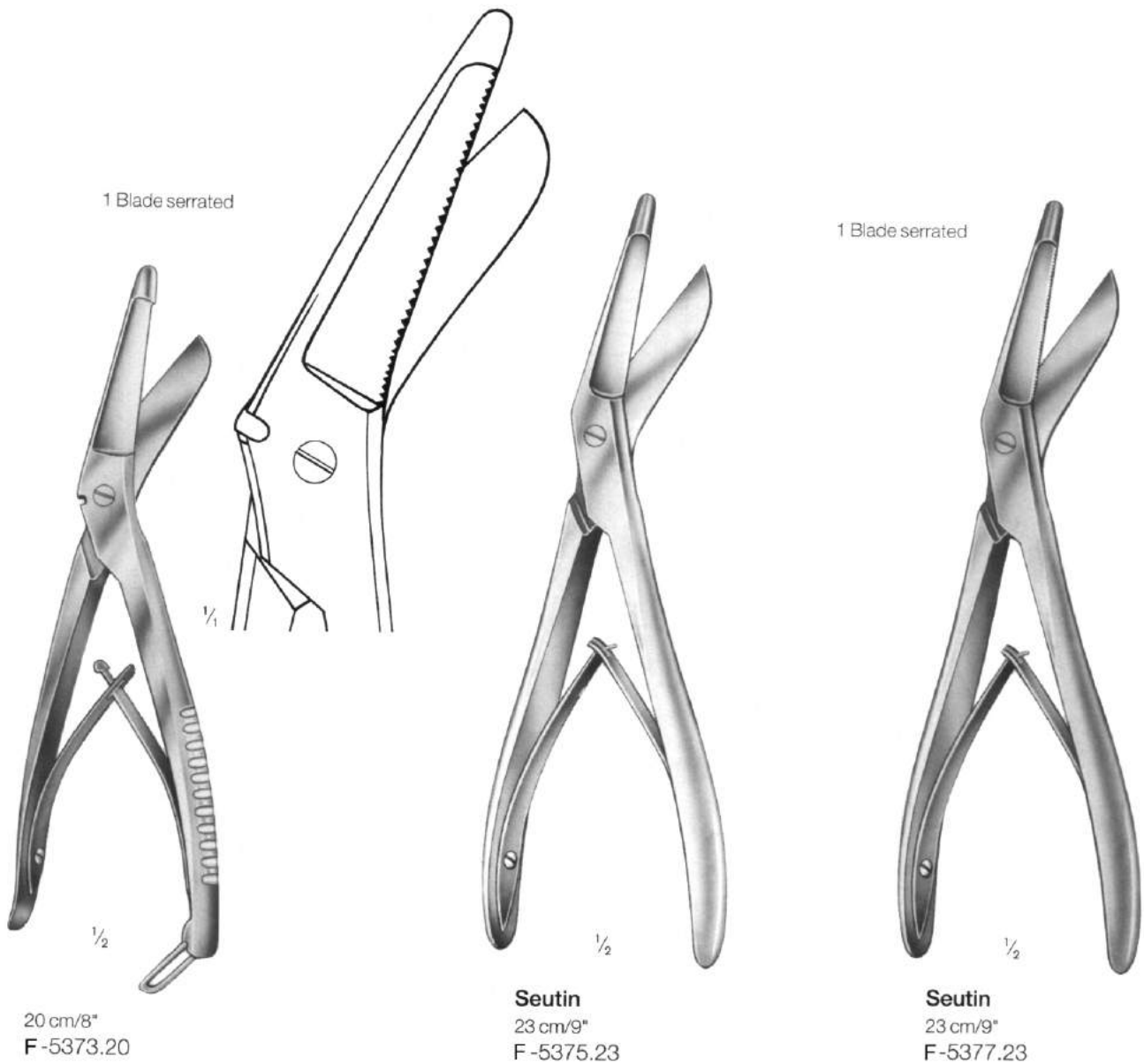

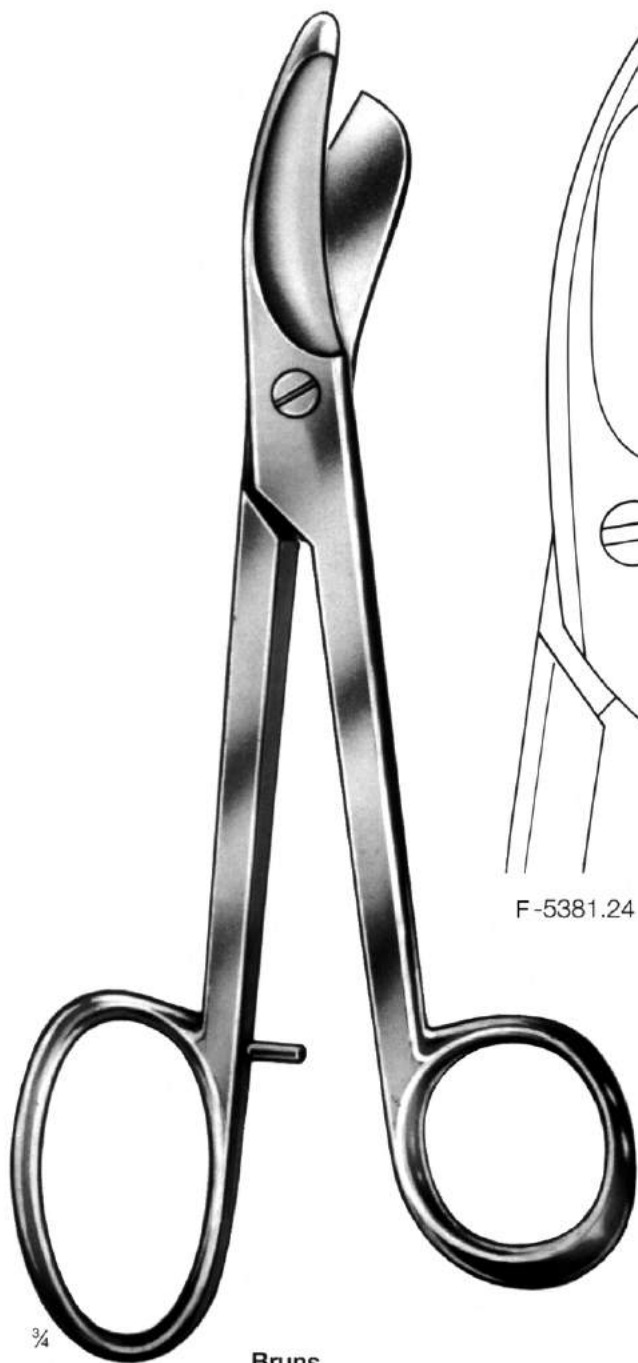

¾

Bruns
24 cm/9 ½"

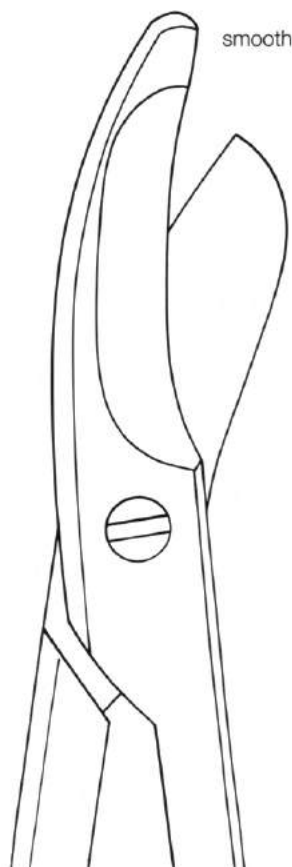

smooth

F-5381.24

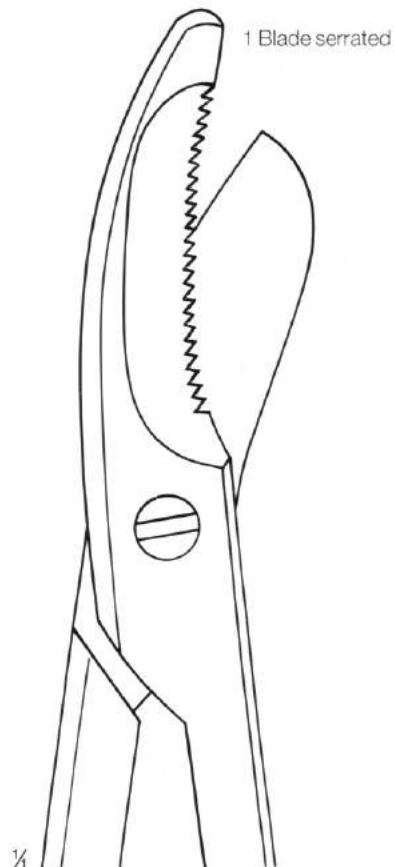

1 Blade serrated

¼

F-5383.24

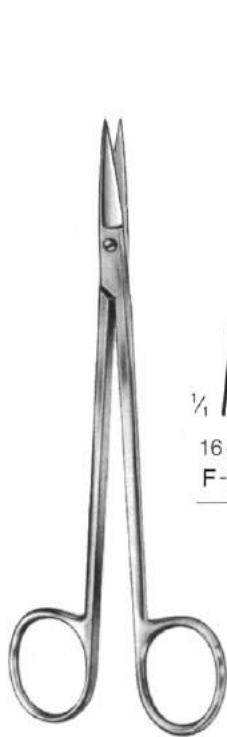

Kelly

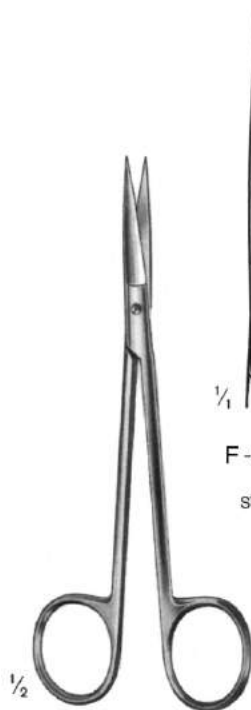
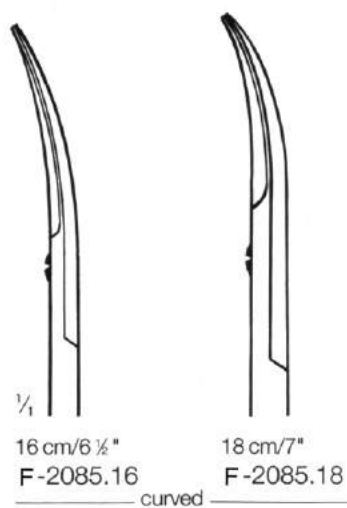
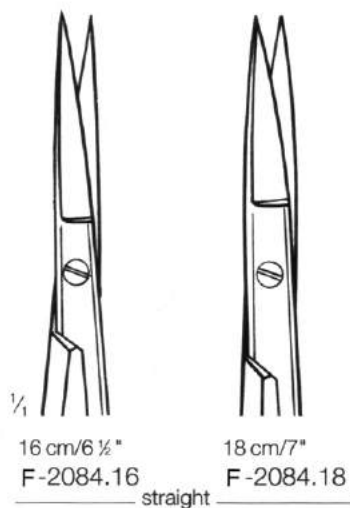

Joseph
 14 cm/5 1/2"

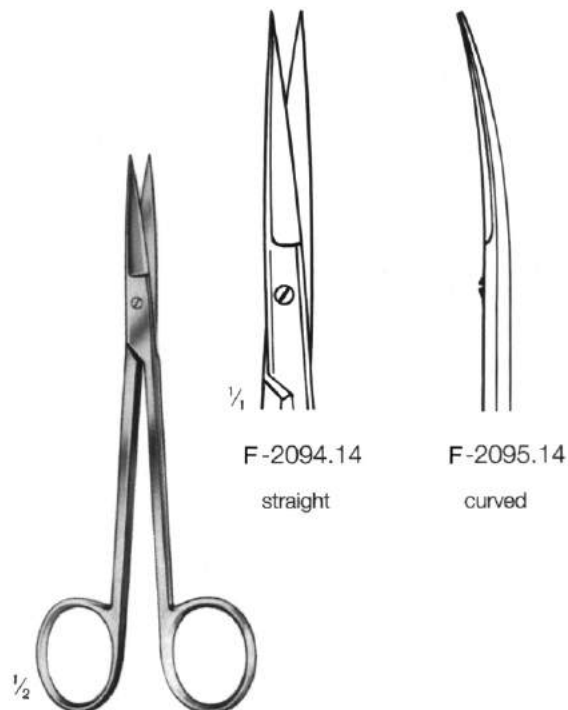
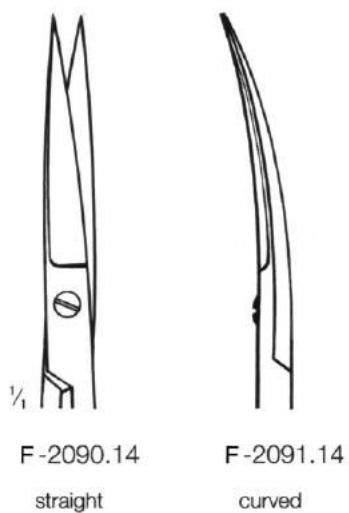

Sanvenero
 14 cm/5 1/2"

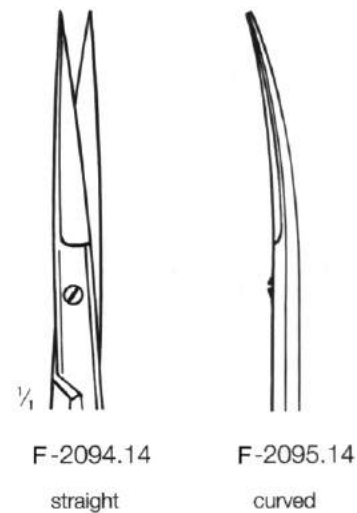



Rees (Face Lifting)
17 cm/6 3/4"
F-2220.17

Rees (Face Lifting)
17 cm/6 3/4"
F-2221.17

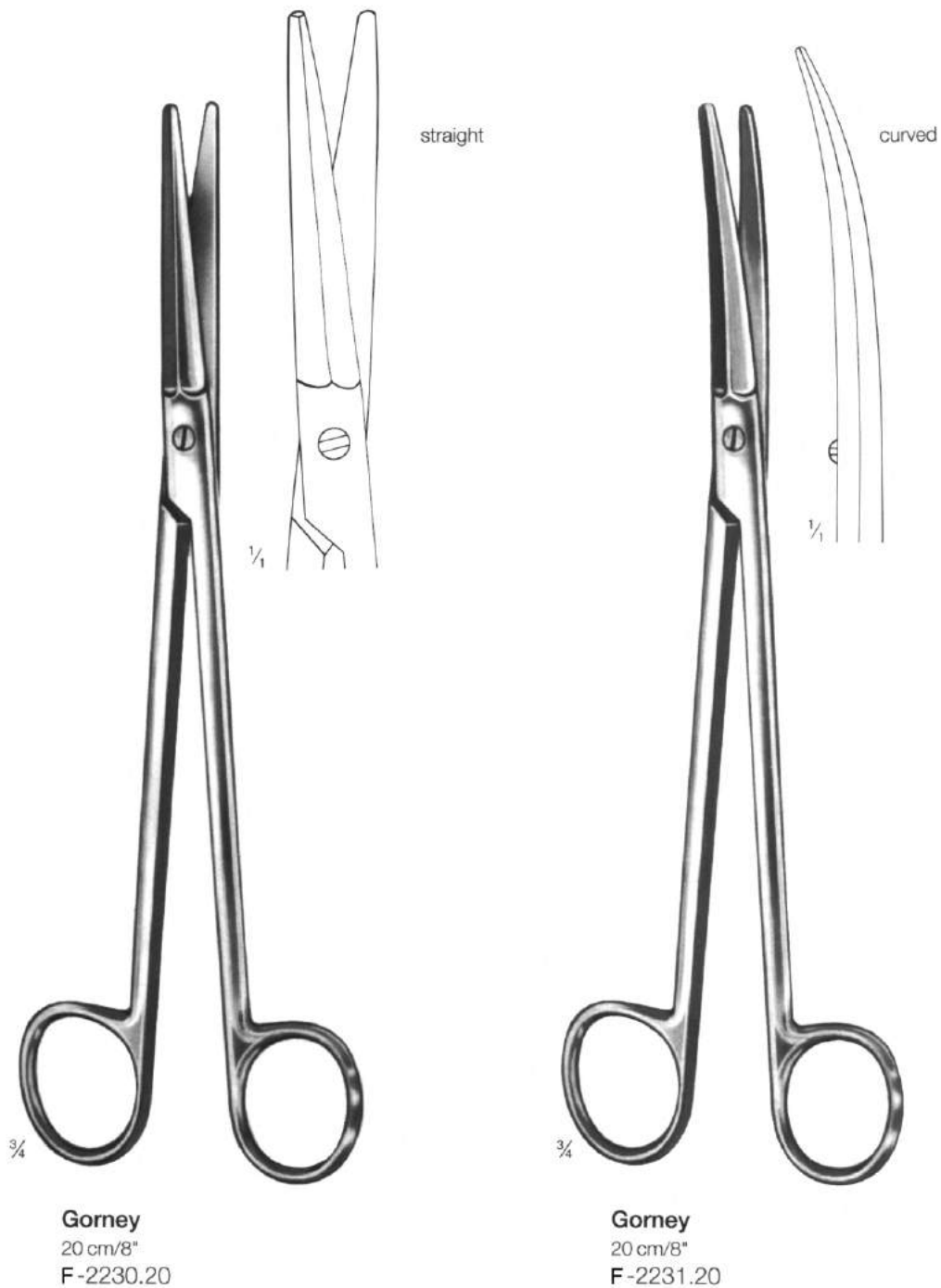



Kahn

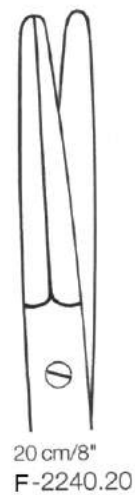
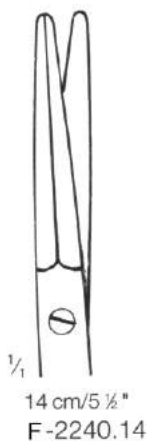

Kahn

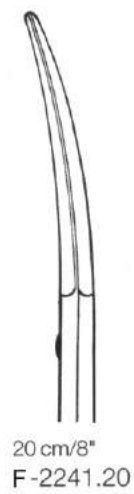
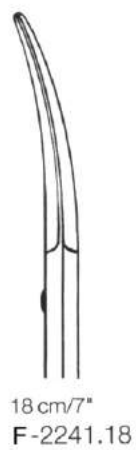
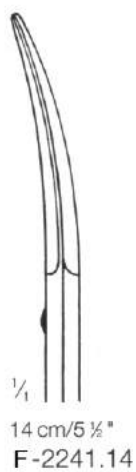

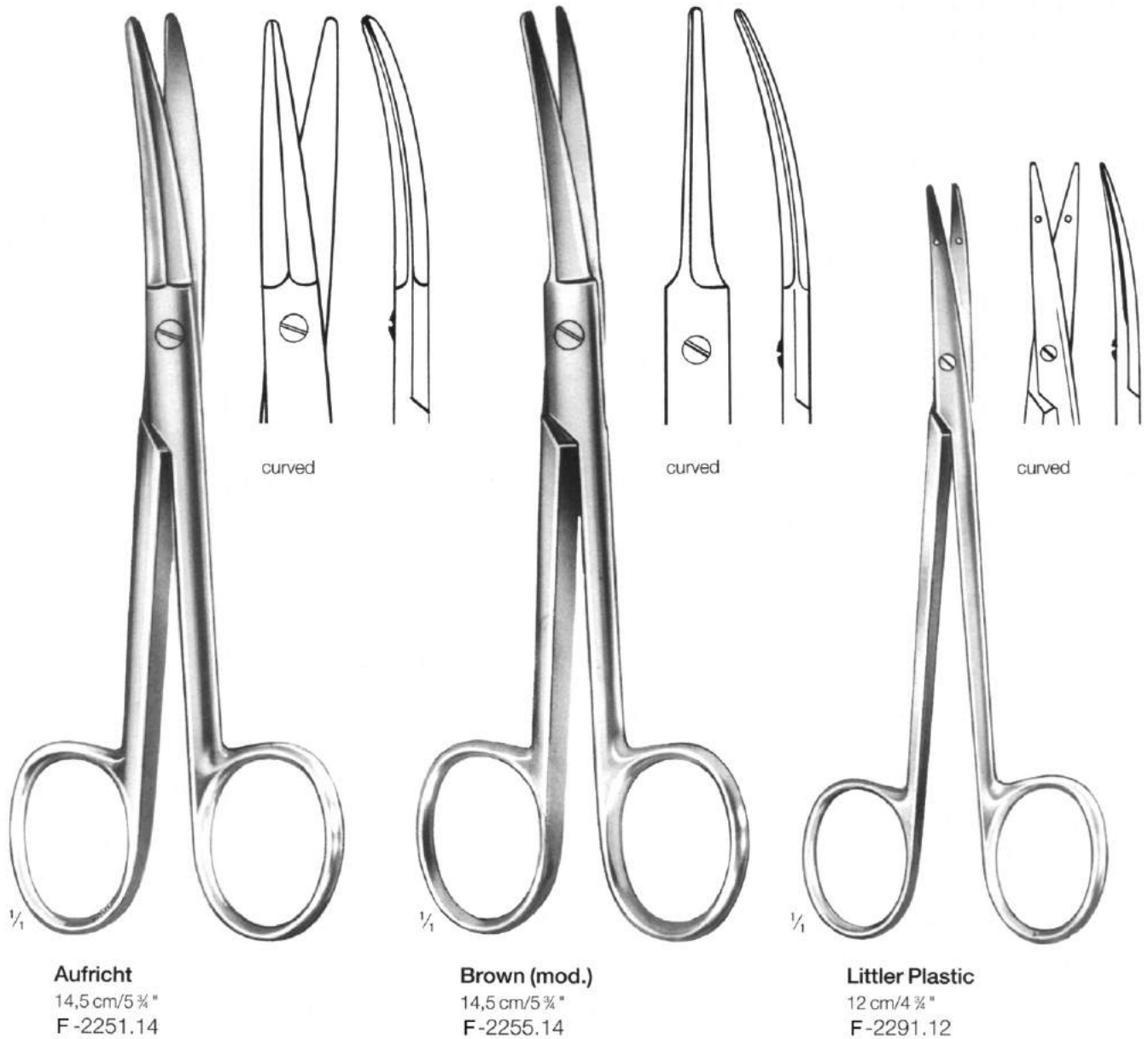



Heymann
 18 cm/7"
 F-2015.18

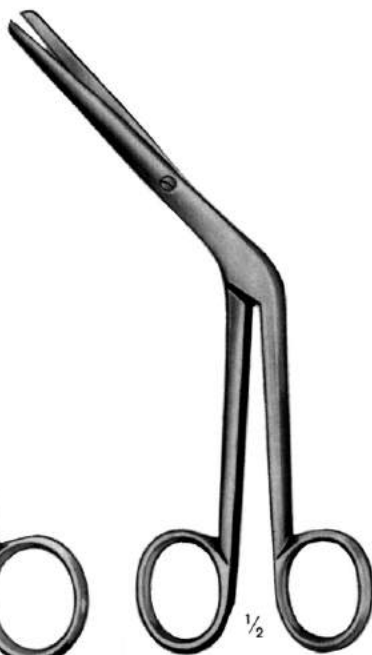

Knight
 18 cm/7"
 F-2019.18

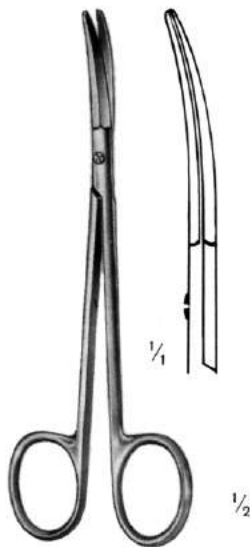

Fomon "Saber Back"
 13,5 cm/5 1/4"
 F-2031.13

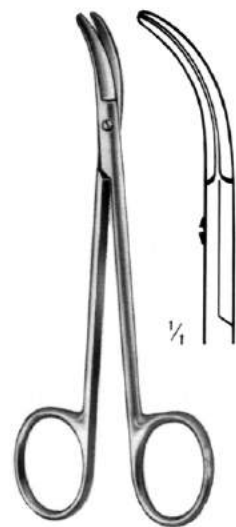

Fomon "Upper Lateral"
 13,5 cm/5 1/4"
 F-2035.13



Fomon
14,5 cm/5 $\frac{5}{8}$ "
F-2051.14

Cottle
17 cm/6 $\frac{6}{8}$ "
F-2055.17

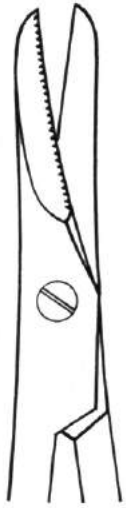

1 Blade serrated



Caplan
 20 cm/8"
 F-2063.20

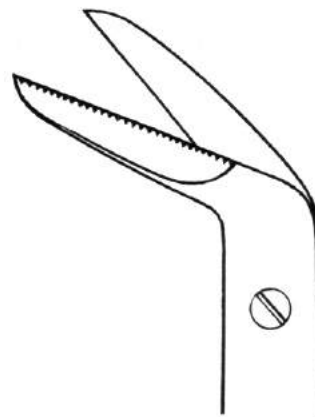

1 Blade serrated



saw edge

13 cm/5"



curved to the right
 F-2069.02



curved to the left
 F-2069.03

Tubular shaft

straight

F-2069.01



Killian
 21 cm/8 1/2"
 F-2067.21

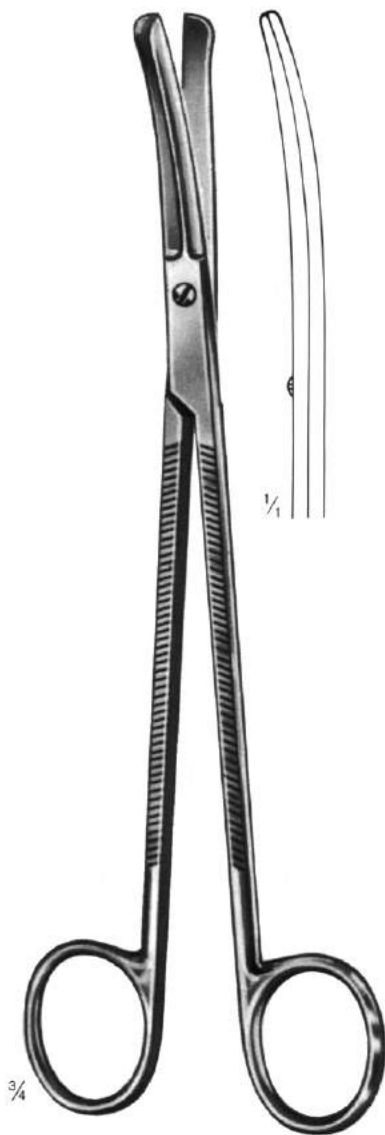

Good
19 cm/7 1/2"
F-3109.19

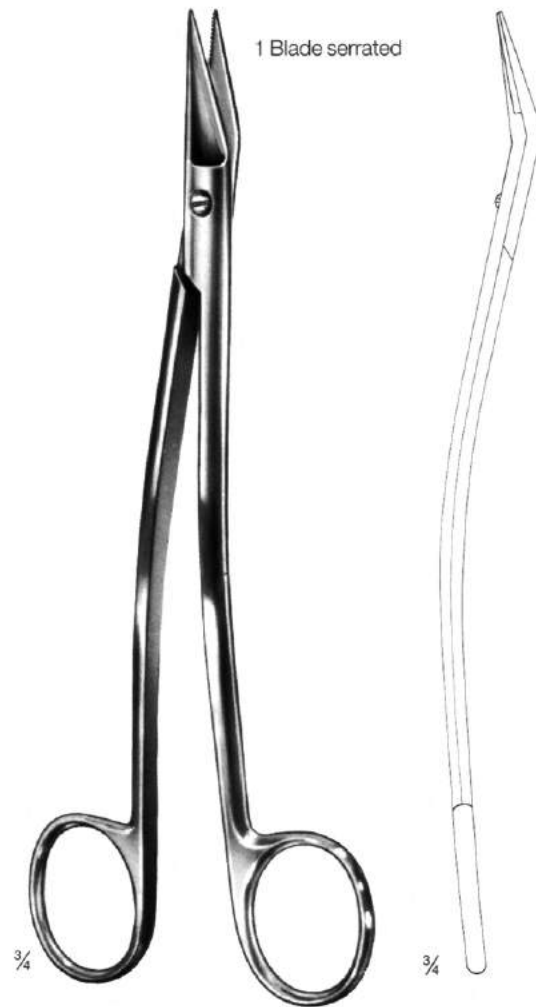

Dean
17 cm/6 3/4"
F-3113.17



Böttcher
18 cm/7"
F-3125.18

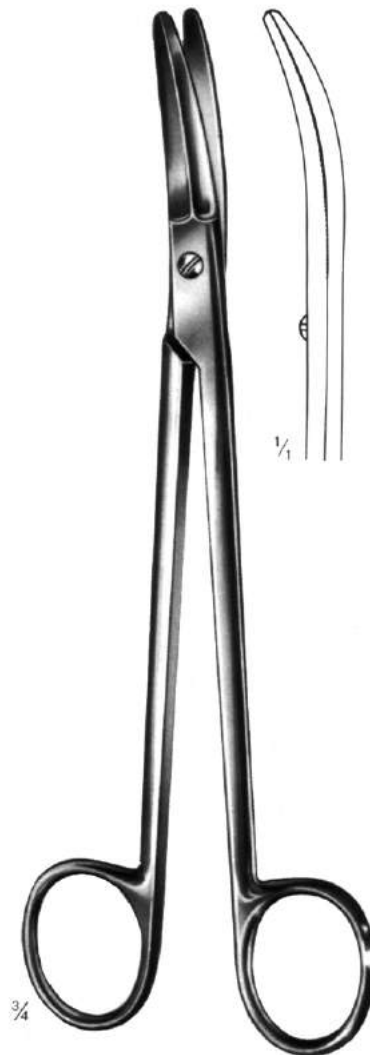

Prince
17,5 cm/6 $\frac{3}{4}$ "
F-3133.17

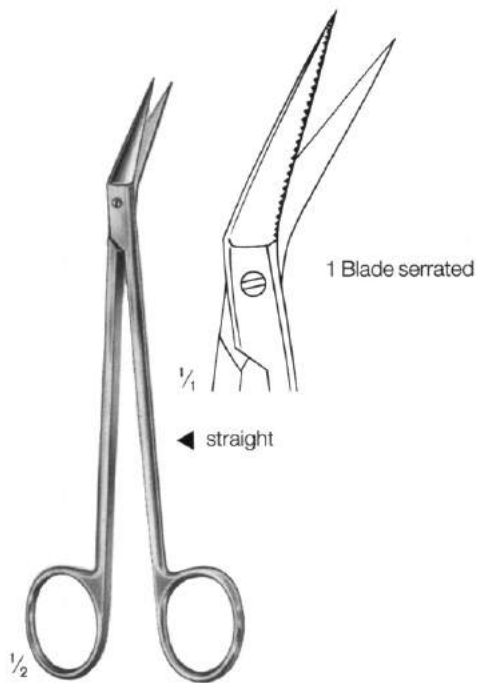

Locklin
16 cm/6 1/4"
F-3221.16

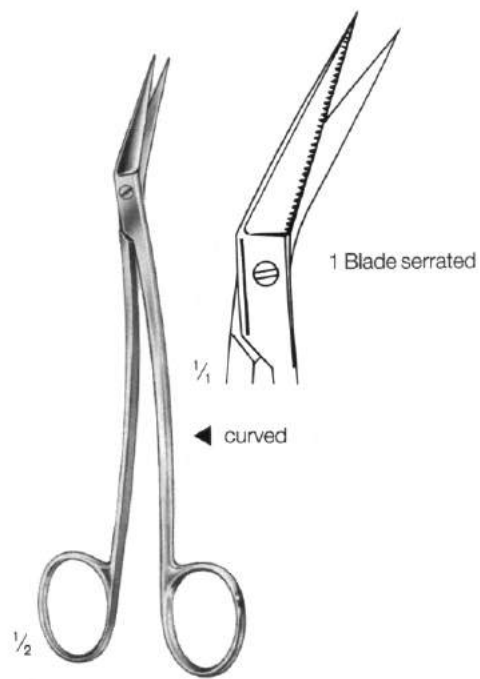

Locklin
16 cm/6 1/4"
F-3223.16

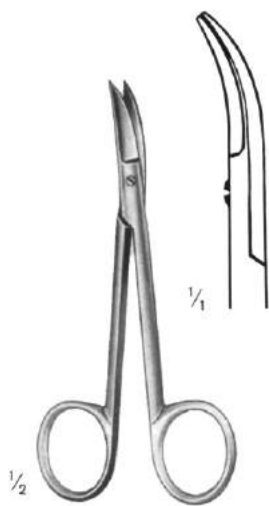

Quinby
12 cm/4 3/4"
F-3231.12



Chadwick
11 cm/4 1/4"
F-3239.11

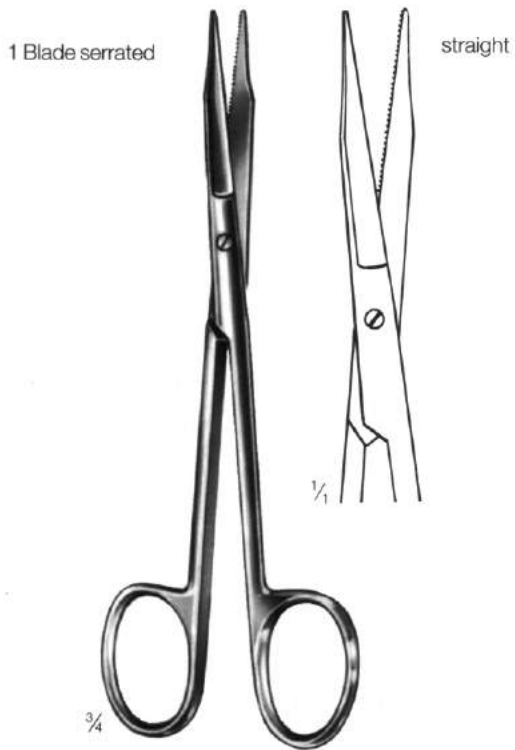

Goldmann-Fox
13 cm/5"
F-3250.13



Goldmann-Fox
13 cm/5"
F-3251.13

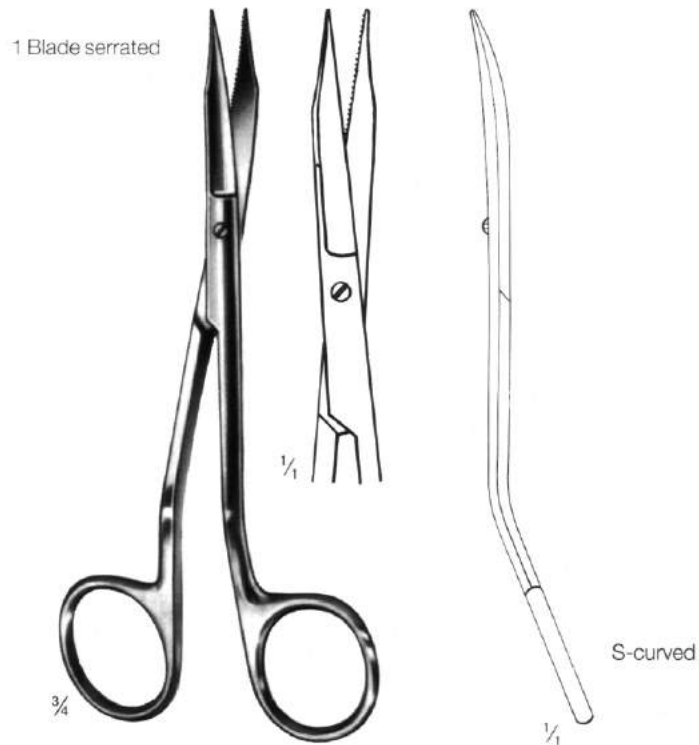

Goldmann-Fox
13 cm/5"
F-3253.13



Favoloro

cm	inch.		
17	6 7/8	60°	F-4211.17
23	9	60°	F-4211.23

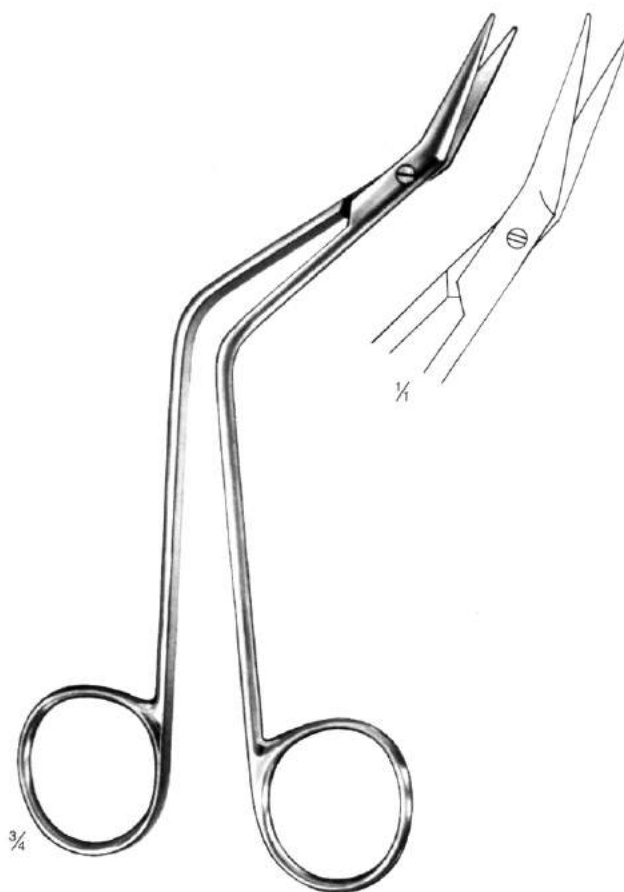

Coronary

17 cm/6 7/8"
 F-4223.17

1 blade with probe

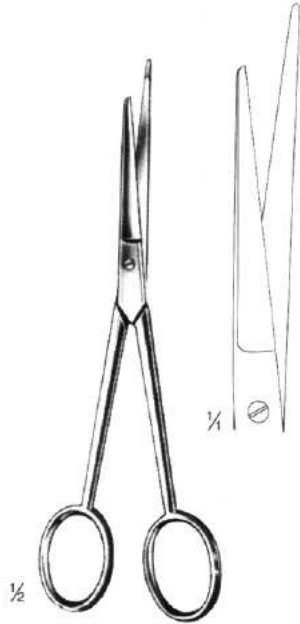

14,5 cm/5 1/2"
 F-4250.14

Coronary Scissors



12 cm/4 3/4"
 F-4256.12

angled on flat



Potts-Smith (de Martel)
 19,5 cm/7 3/4"
 F-4265.19

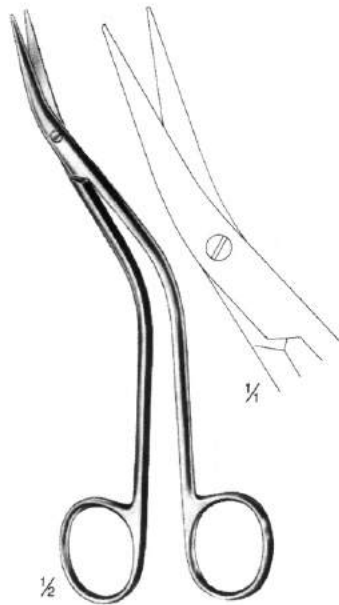

DeBakey
 15,5 cm/6"
 F-4273.15

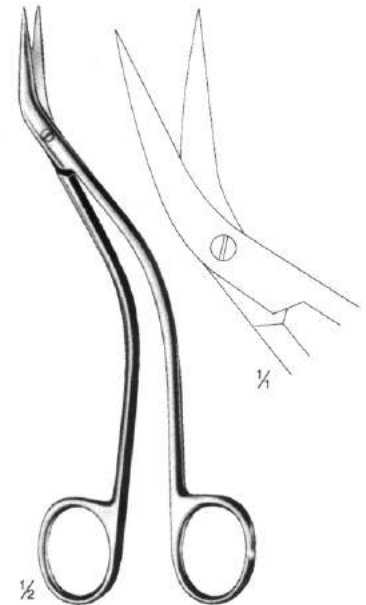

DeBakey
 15,5 cm/6"
 F-4277.15

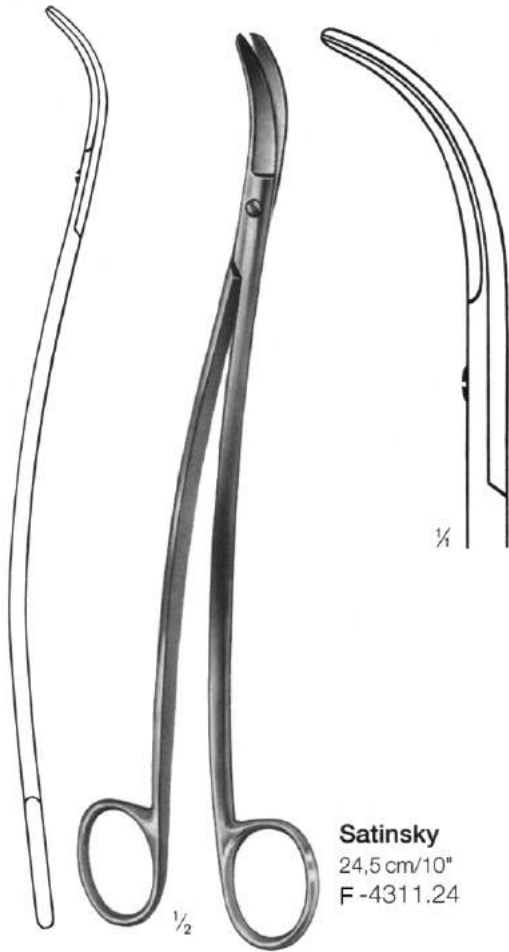

Satinsky
 24,5 cm/10"
 F-4311.24

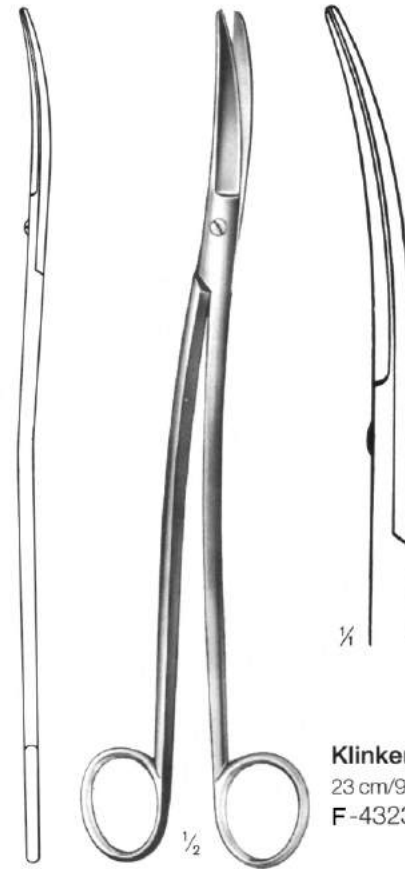

Klinkenbergh-Loth
 23 cm/9"
 F-4323.23

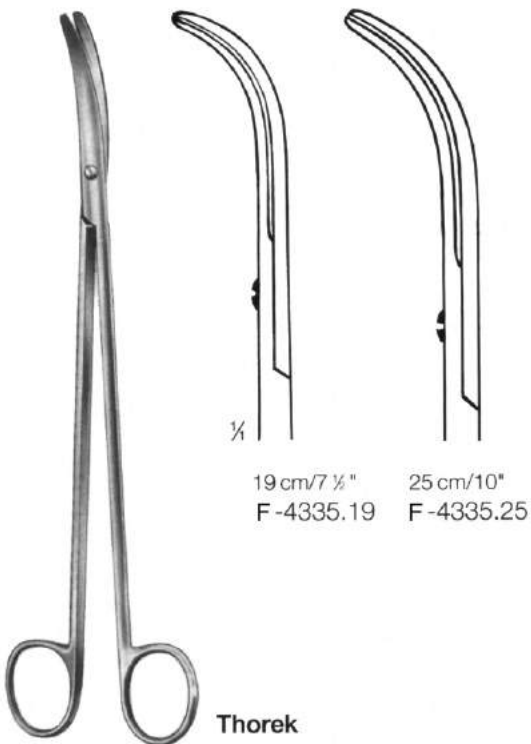

Thorek

19 cm/7 1/2" F-4335.19
 25 cm/10" F-4335.25

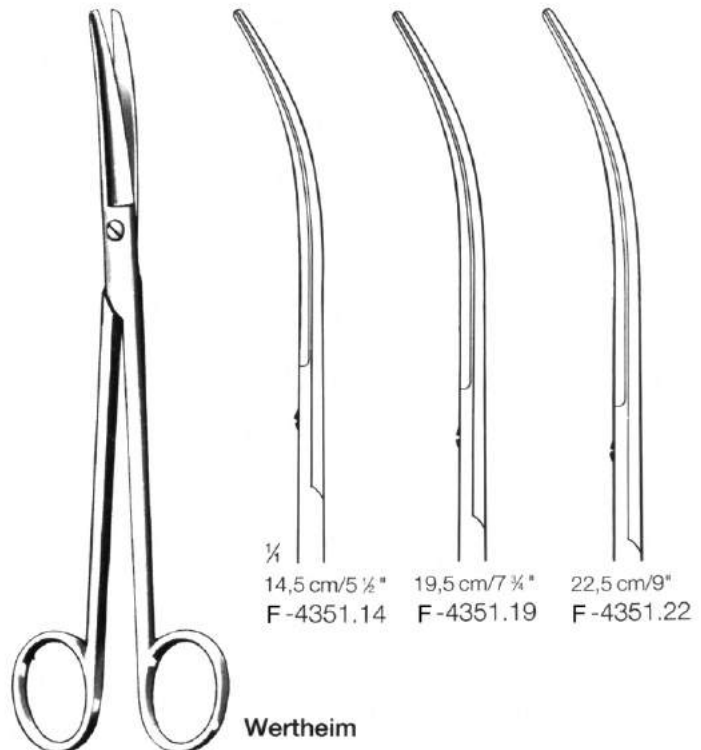

Wertheim

14,5 cm/5 1/2" F-4351.14
 19,5 cm/7 3/4" F-4351.19
 22,5 cm/9" F-4351.22



16 cm/6 1/4"
F-4416-25

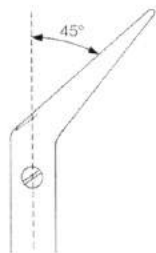

16 cm/6 1/4"
F-4416.45

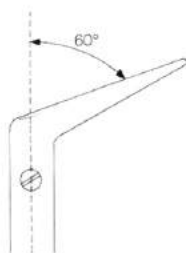

16 cm/6 1/4"
F-4416.60



19 cm/7 1/2"
F-4439.25

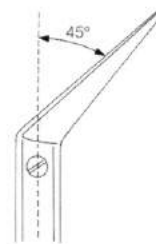

19 cm/7 1/2"
F-4439.45

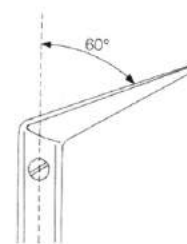

19 cm/7 1/2"
F-4439.60

23 cm/9"
F-4423.25

23 cm/9"
F-4423.45

23 cm/9"
F-4423.60

28 cm/11"
F-4428.25

28 cm/11"
F-4428.45

28 cm/11"
F-4428.60



DeBakey

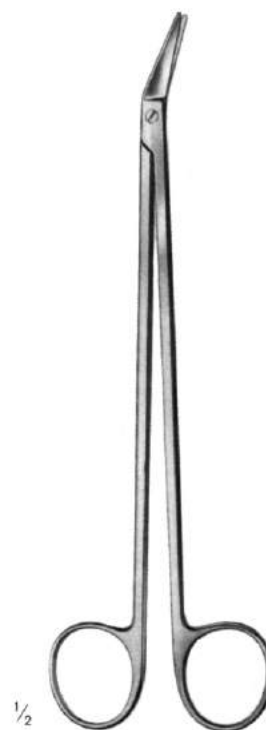

Potts-Smith

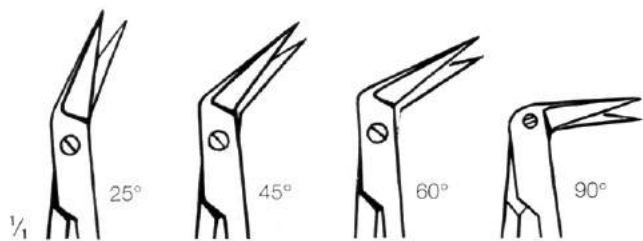

13 cm/5"

F-4453.25 F-4453.45 F-4453.60 F-4453.90

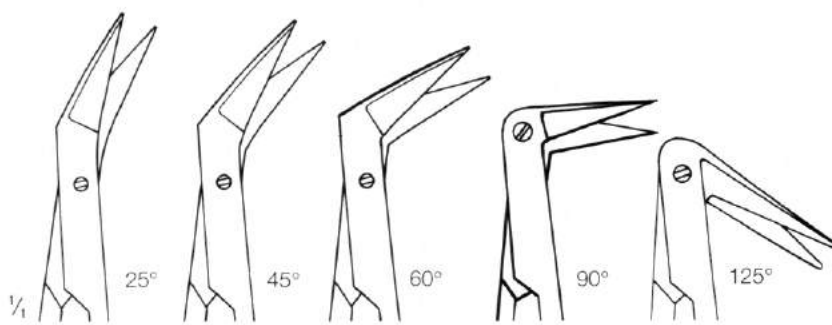

18 cm/7"

F-4468.25 F-4468.45 F-4468.60 F-4468.90 F-4468.99



Diethrich
 F-4453.##
 F-4468.##

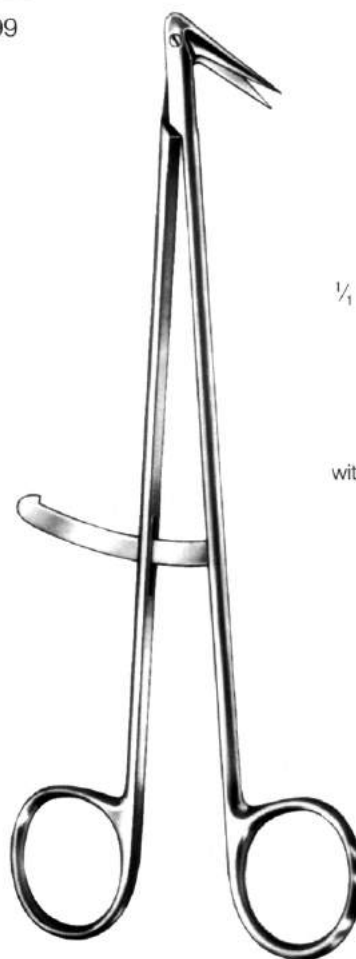

Diethrich
 18 cm/7"
 F-4469.99

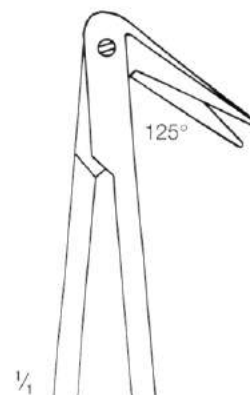

with guide bar

Trigeminal Scissors

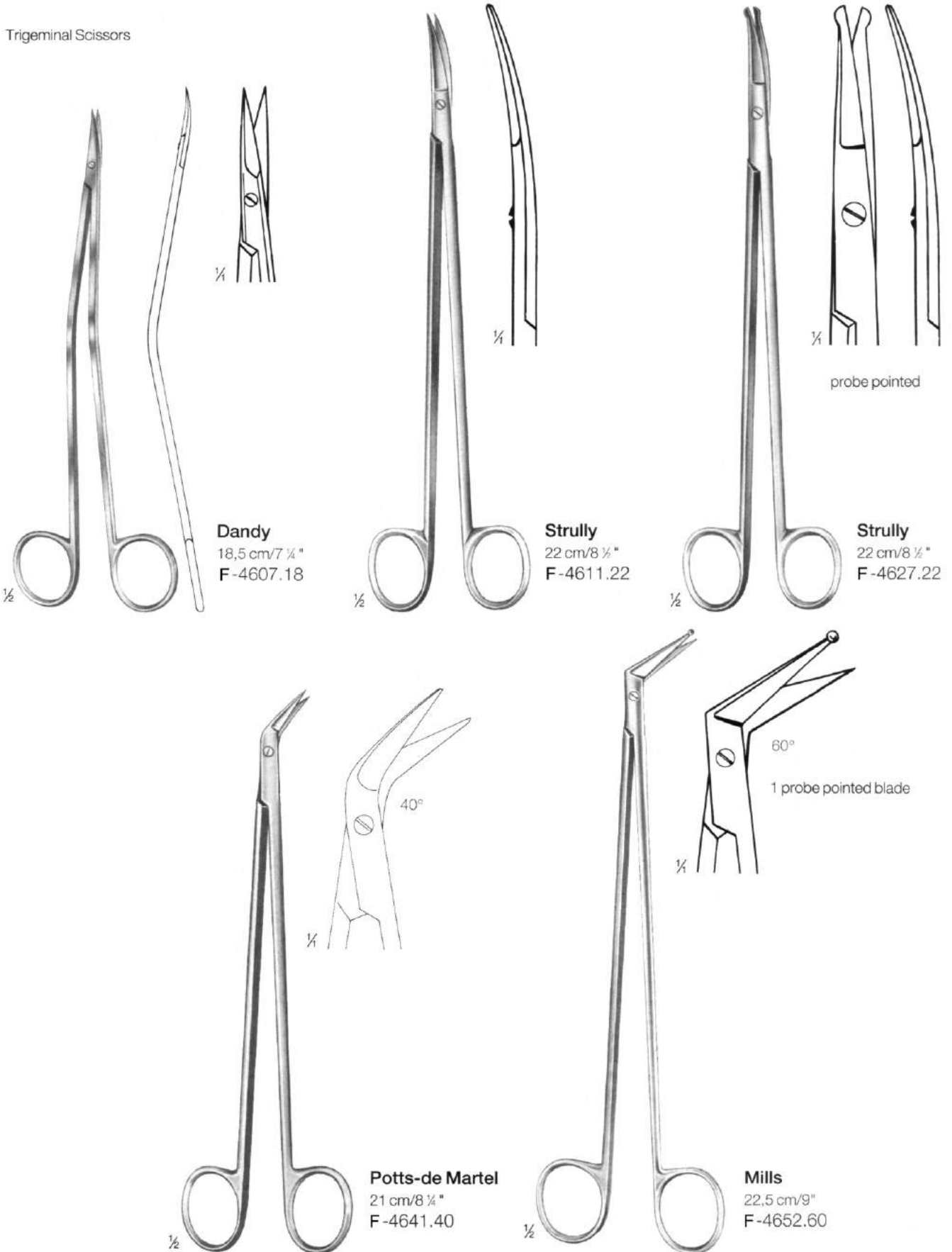

Dura Scissors

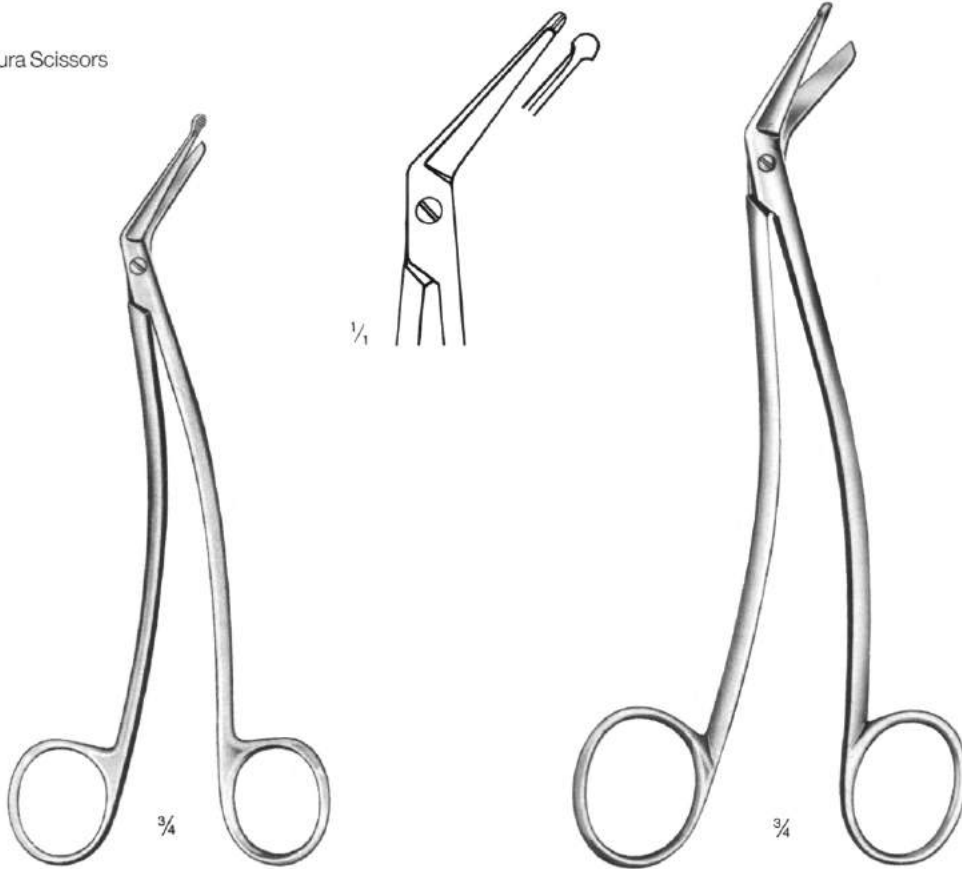

Taylor
 14,5 cm/5 7/8"
 F-4665.14

Schmieden
 17 cm/6 3/4"
 F-4669.17

saw edge

Working length: 13 cm/5"

Neurosurgical Scissors (also nasal)

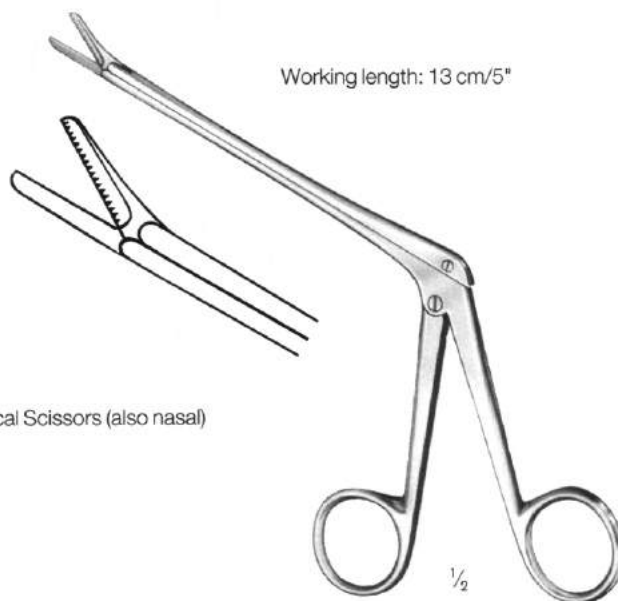

Olivecrona
 21,5 cm/8 1/2"
 F-4680.13

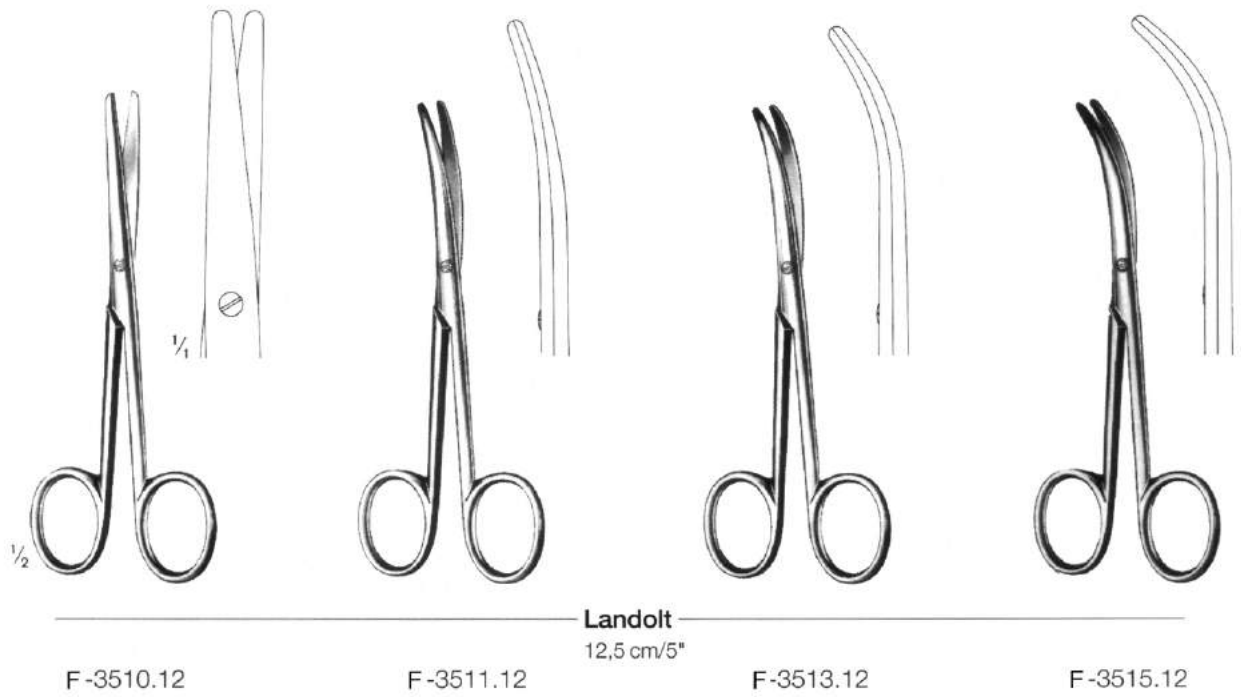

Fine Dissecting Scissors

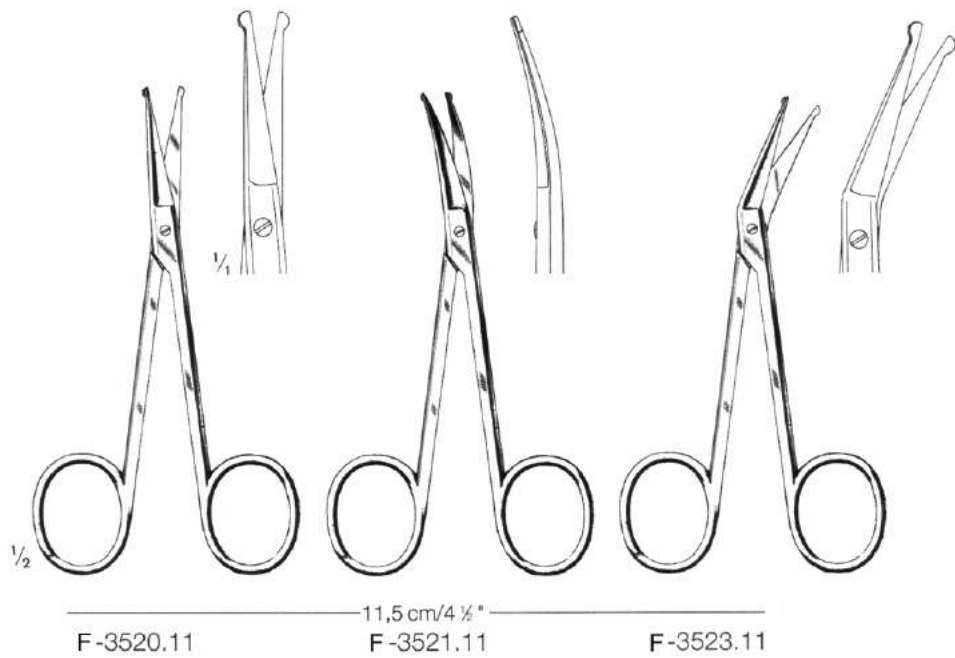

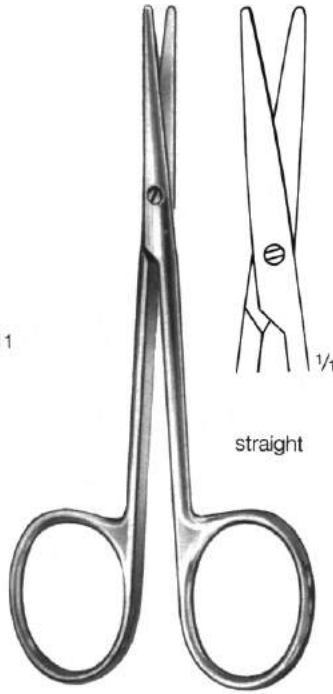
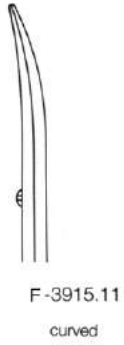

Strabismus Scissors

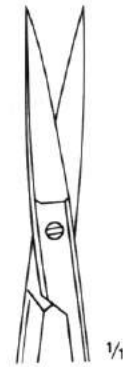
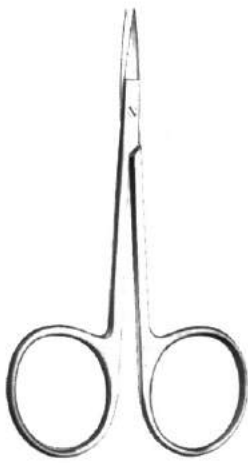
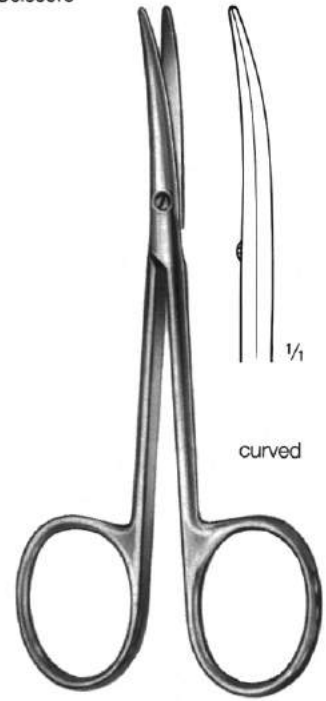

cm	inch.	F-3564.09	F-3565.09
9,0	3 1/2		
10,5	4		



Spencer

cm inch.

9 3 1/2 F-5010.09

12 4 3/4 F-5010.12



1/2

Shortbent

9 cm/3 1/2"

F-5011.09



1/2

Northbent

12,5 cm/5"

F-5011.12



1/2

11,5 cm/4 1/2"

F-5013.11



1/2

Littauer

14 cm/5 1/2"

F-5020.14



1/2

Heath

15 cm/6"

F-5025.15



1/2

O'Brien

9,5 cm/3 3/4"

F-5031.09



1/4

1/2

Eiselsberg

11 cm/4 1/4"

F-5040.11

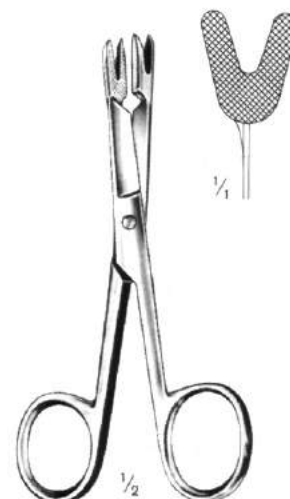

1/4

1/2

Schoemaker-Loth

12,5 cm/5"

F-5044.12

Enterotomy Scissors

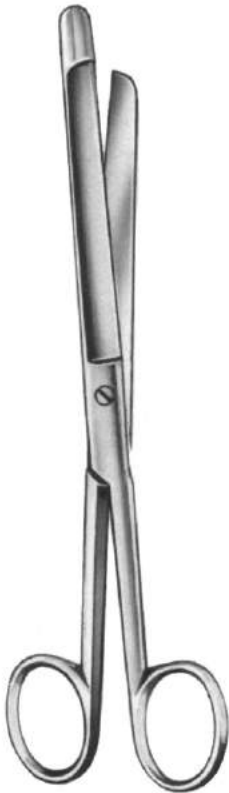

21 cm/8 1/4"
F-5610.21

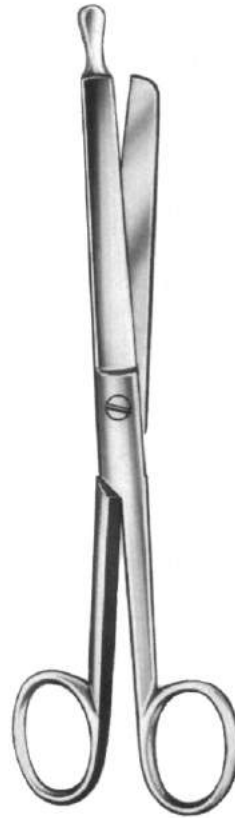

21 cm/8 1/4"
F-5614.21

Bone- and Rib Shears



23 cm/9"
F-5650.23

Coronary Scissors



Plain
23 cm/9"
F-5660.23

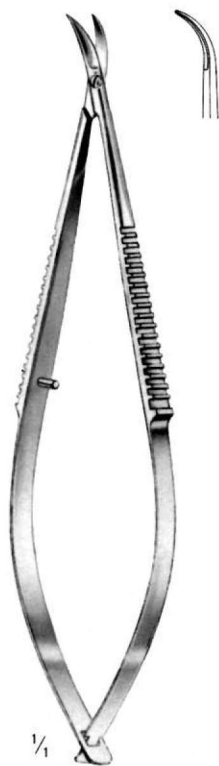

Castroviejo
 10 cm/4"
 F-6051.10
 Micro Scissors, strongly
 curved – blunt/blunt

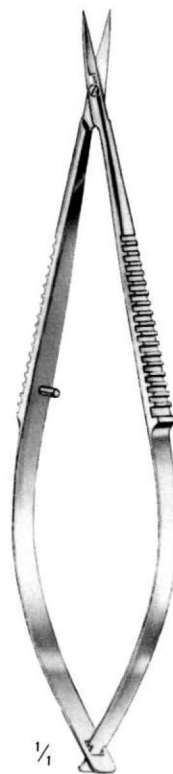

Micro
 10 cm/4"



straight
 sharp/sharp
 F-6060.10



curved
 blunt/blunt
 F-6061.10



curved
 sharp/sharp
 F-6063.10



G

- Retractors
- Ecarteurs
- Separadores

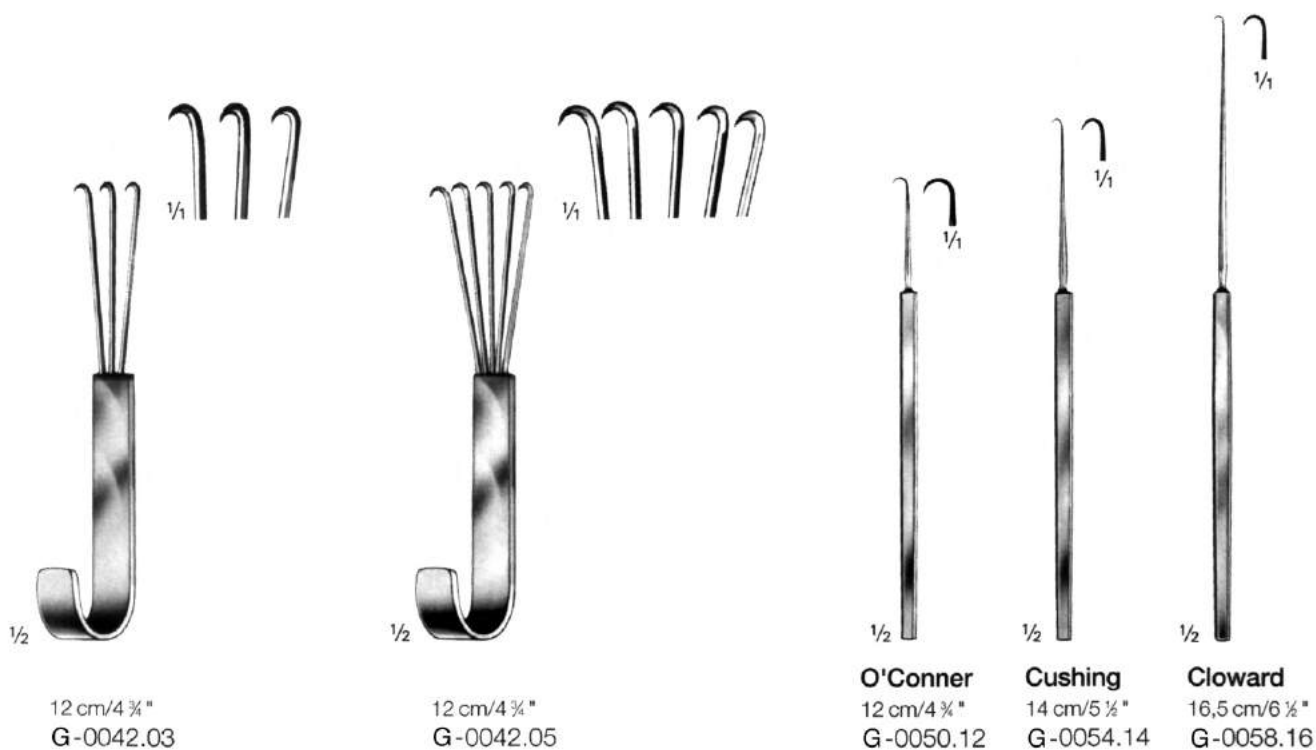
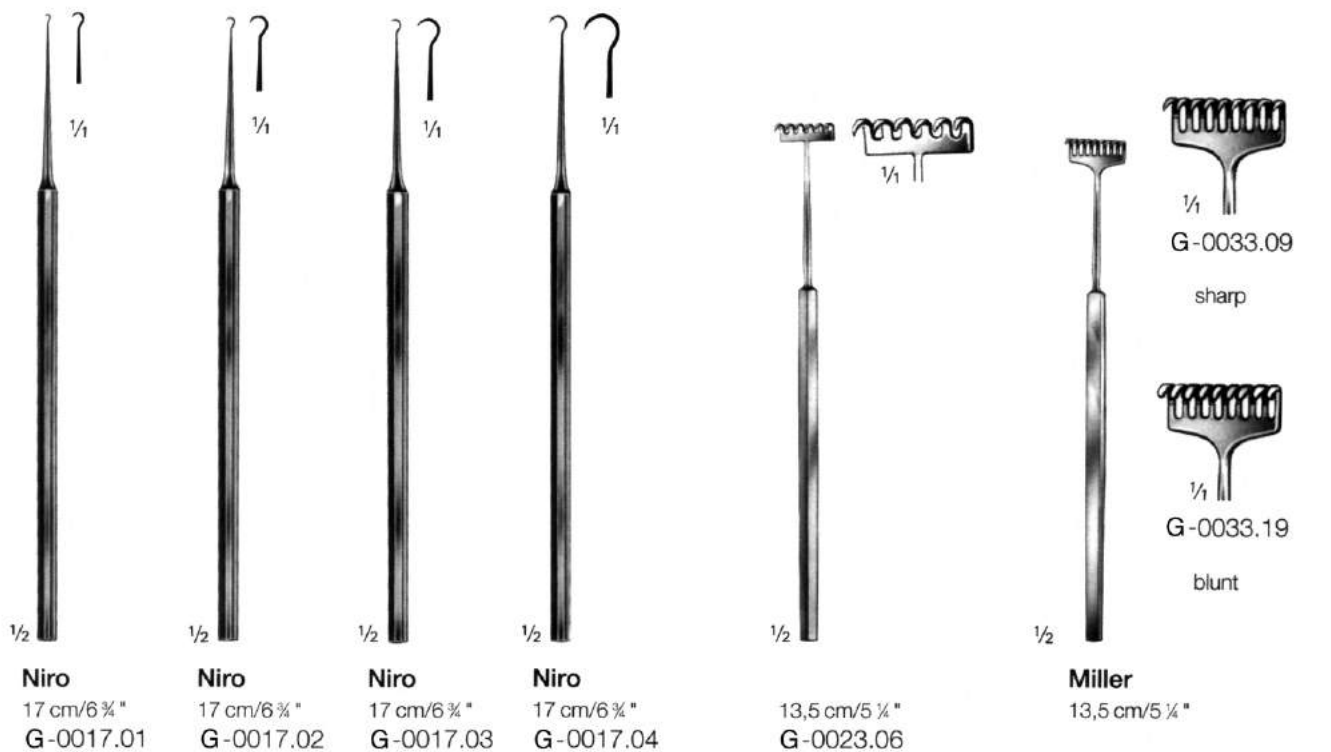

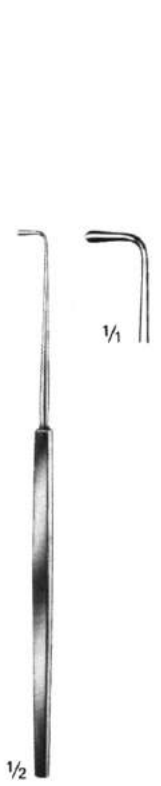

Crile
 14,5 cm/5 3/8"
 G-0100.14



Crile
 20 cm/8"
 G-0100.20

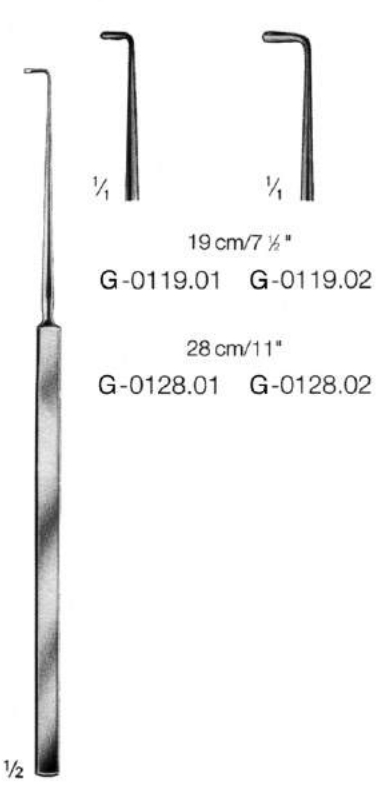

Cushing

19 cm/7 1/2"
 G-0119.01 G-0119.02
 28 cm/11"
 G-0128.01 G-0128.02



Adson
 20 cm/8"
 G-0130.20



Adson
 20 cm/8"
 G-0132.20



Cushing
 13 cm/5"
 G-0134.14



Frazier

18 cm/7"
 G-0136.18



18 cm/7"
 G-0138.18



Tönnis
 15 cm/6"
 G-0144.15



Kleinert-Kutz
 16 cm/6 1/4"

G-0156.03 G-0156.05 G-0156.07

Wound and trachea retractors, mucous hooks
Crochets à plaies et crochets à trachée, crochets pour la muqueuse
Ganchos y separadores para la tráquea, ganchos para las conas

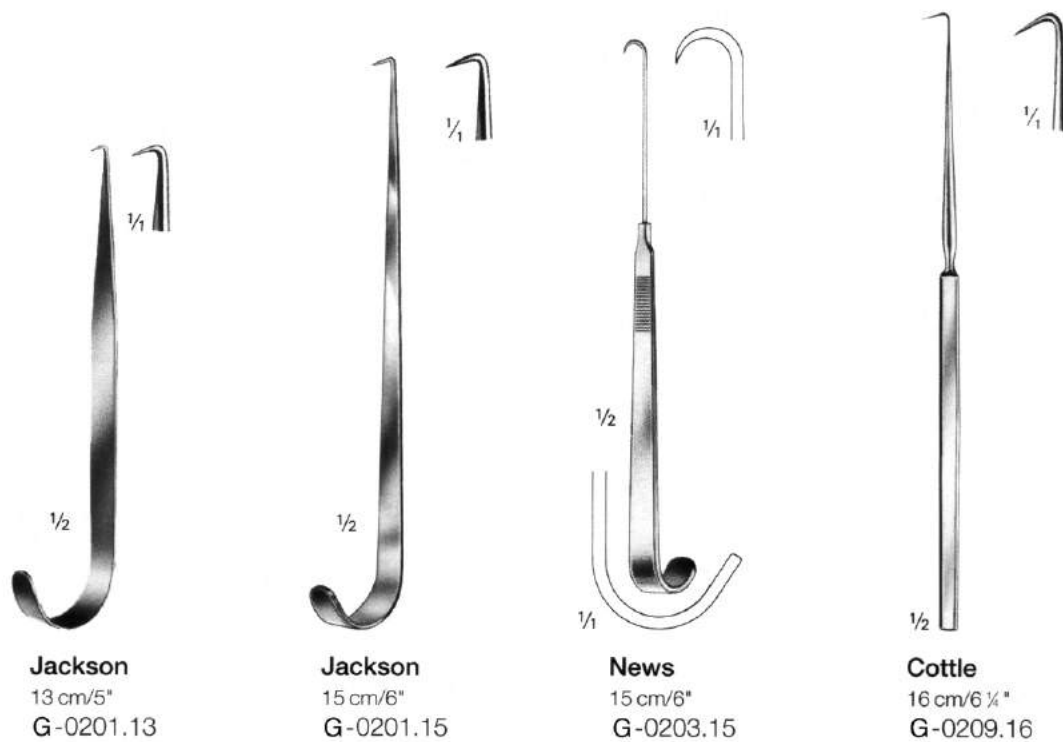
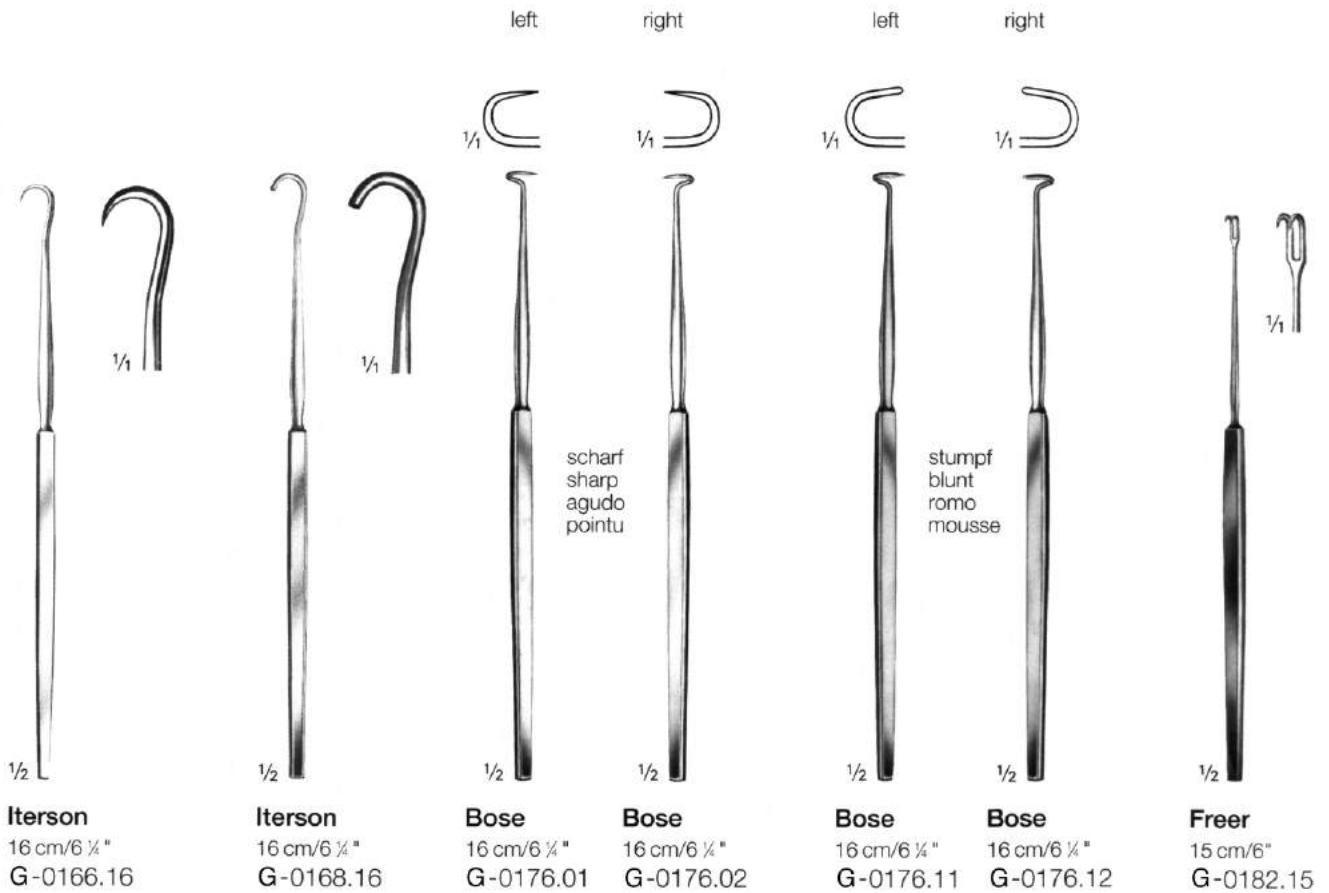

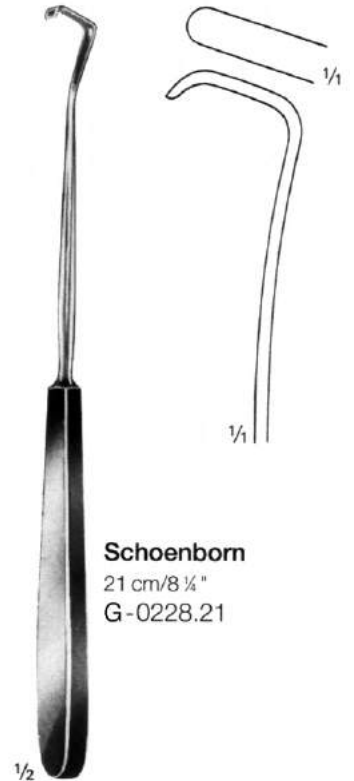

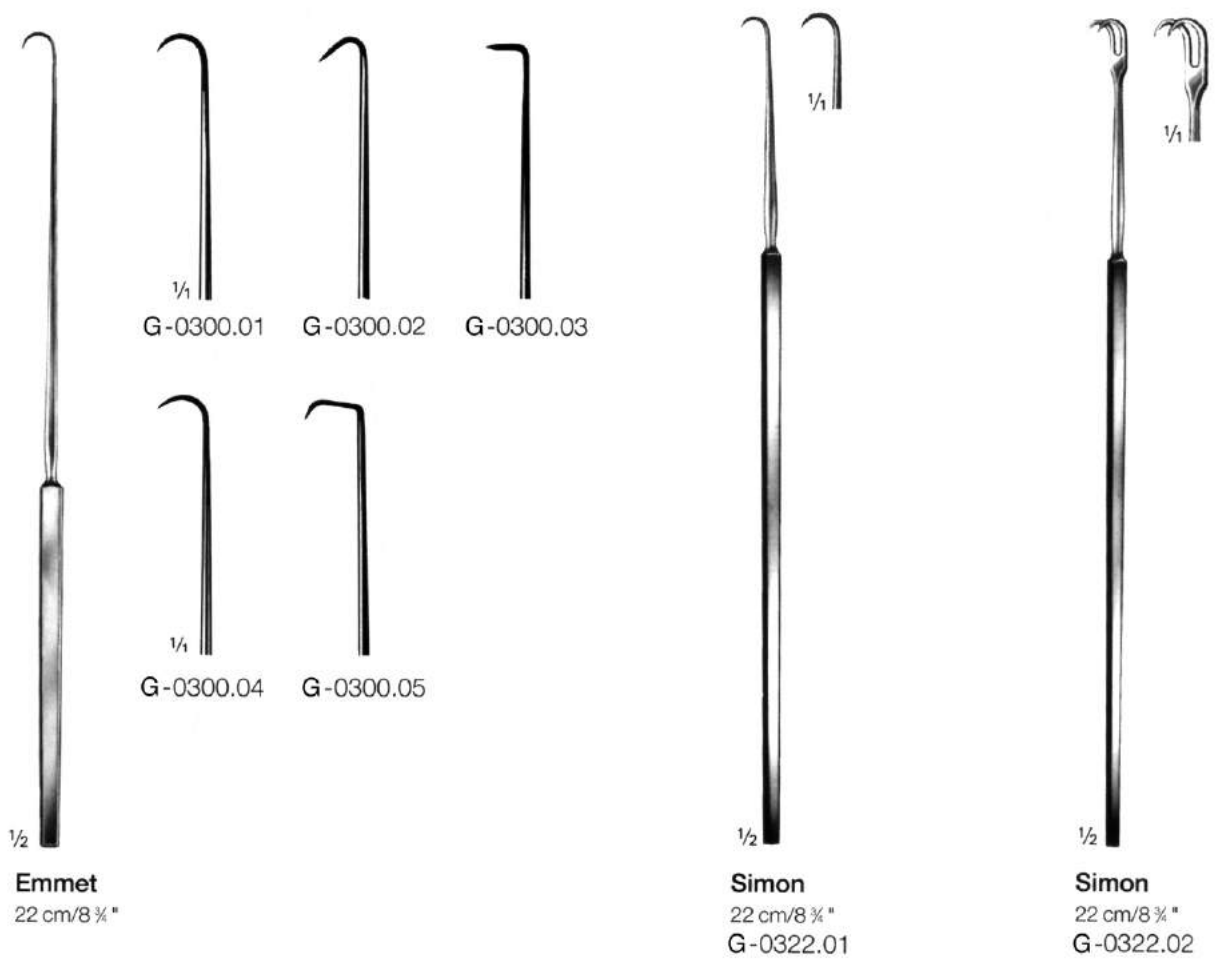

Iris Hooks

Fixation Hooks, double

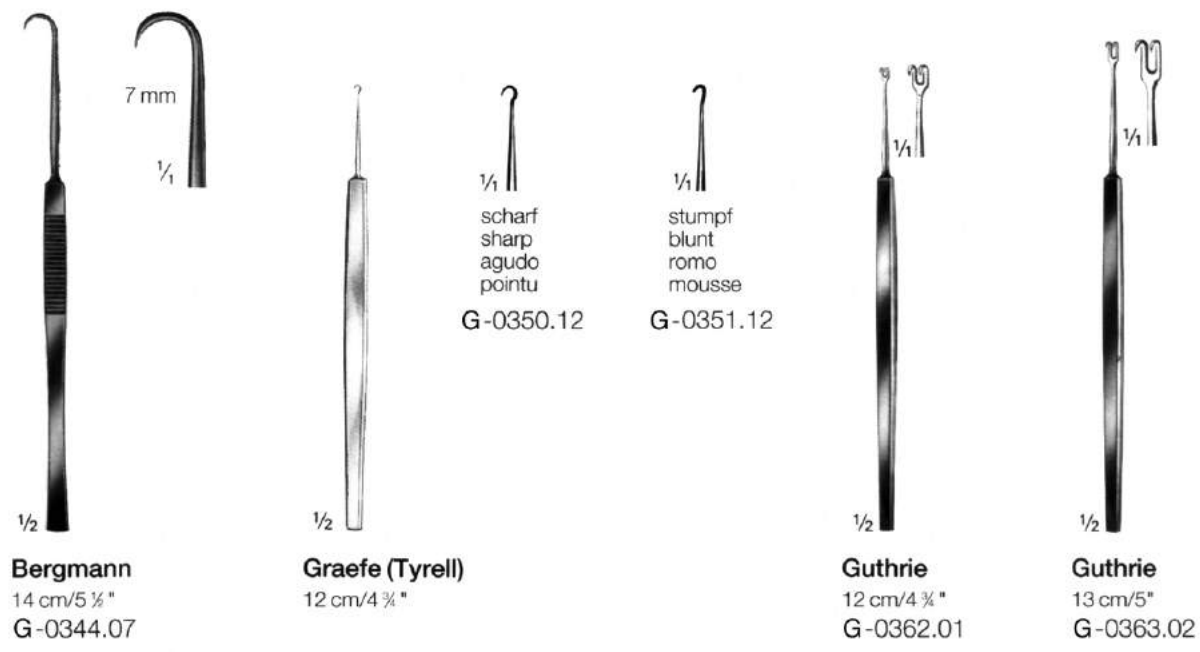

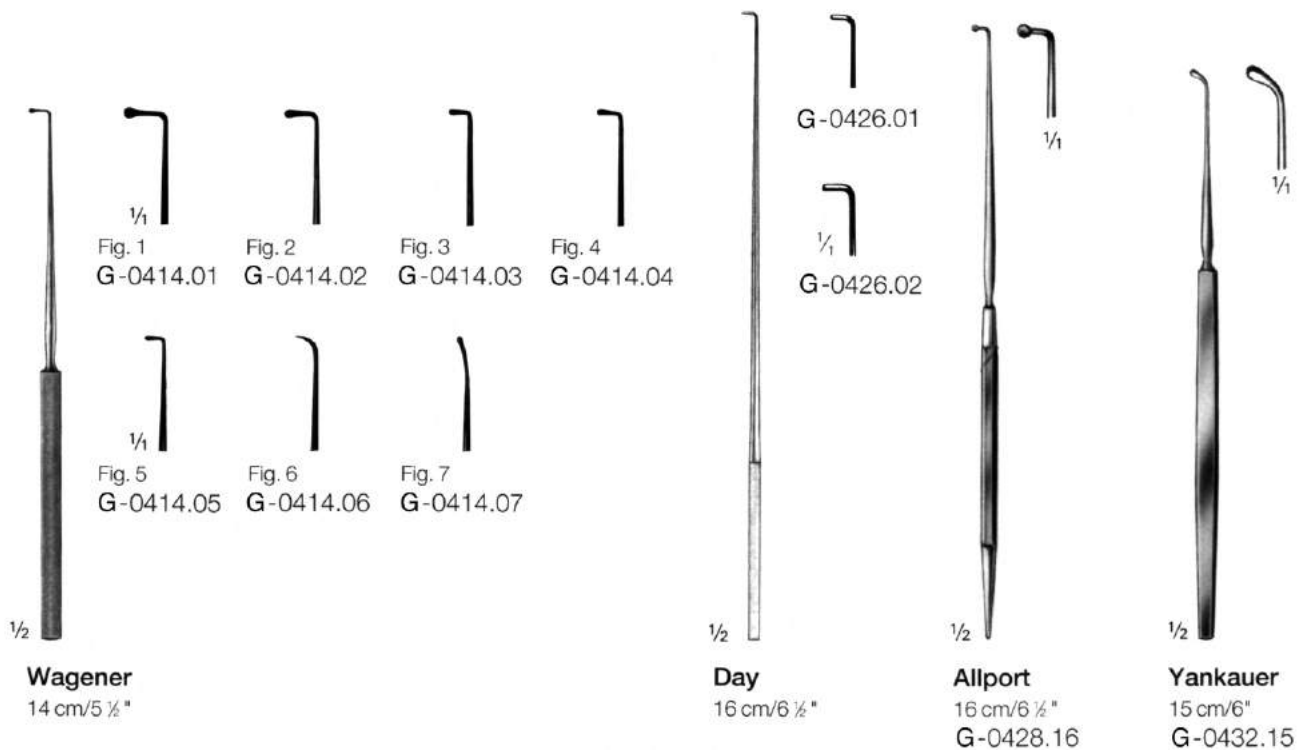



Smithwick
 17 cm/6 1/2" G-3030.17
 21 cm/8 1/4" G-3030.21

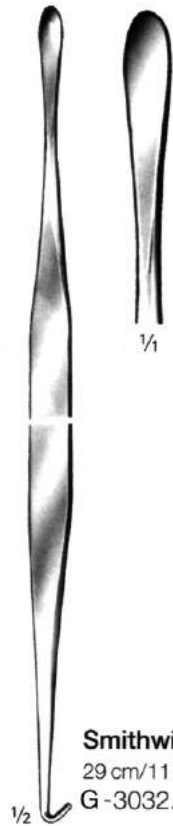

Smithwick
 29 cm/11 1/2" G-3032.29



Frazier
 19 cm/7 1/2" G-3039.01



Frazier
 19 cm/7 1/2" G-3039.02



Hoen
 22 cm/8 3/4" G-3042.22



Dandy
 20 cm/8" G-3045.01



Dandy
 20 cm/8" G-3044.20



Dandy
 20 cm/8" G-3045.02



Adson
 23 cm/9" G-3050.23



Graham
 16,5 cm/6 1/2" G-3054.16



Sachs
 18,5 cm/7 1/4" G-3056.18



Cloward
 16 cm/6 1/2" G-3072.16

Nerve root retractors
Rétracteurs pour racines nerveuses
Separadores para raiz de nervios



Scoville
 23 cm/9"
 G-3010.23

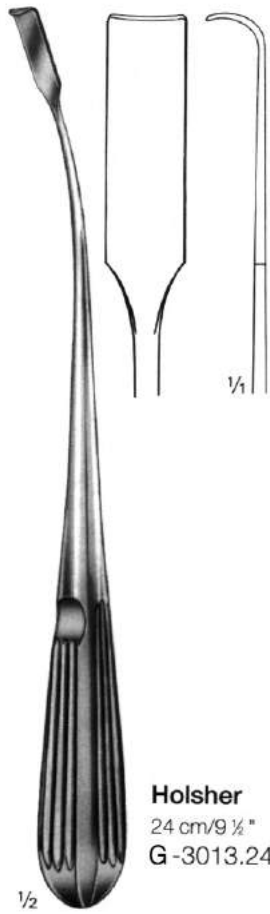

Holsher
 24 cm/9 1/2"
 G-3013.24

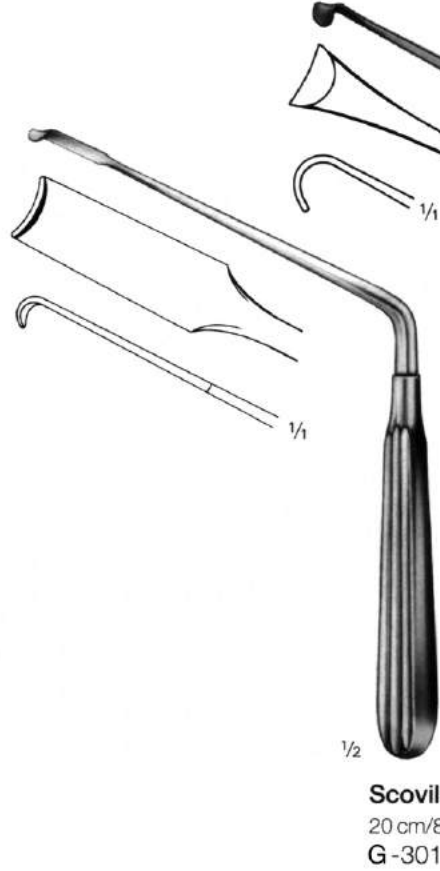

Scoville
 20 cm/8"
 G-3010.20

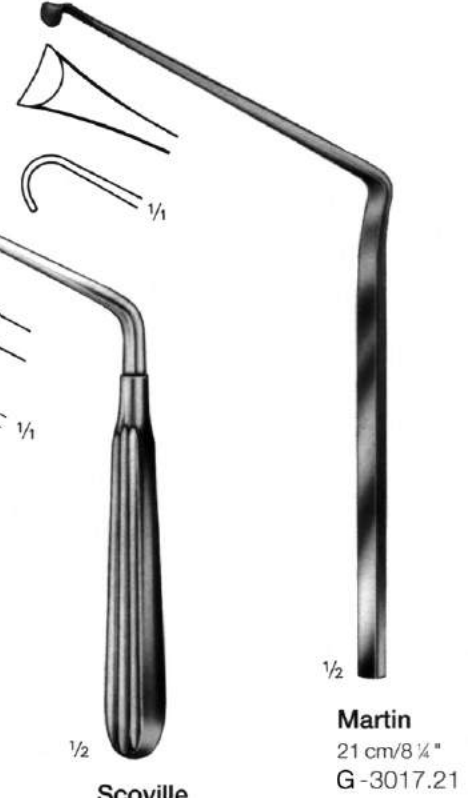

Martin
 21 cm/8 1/4"
 G-3017.21

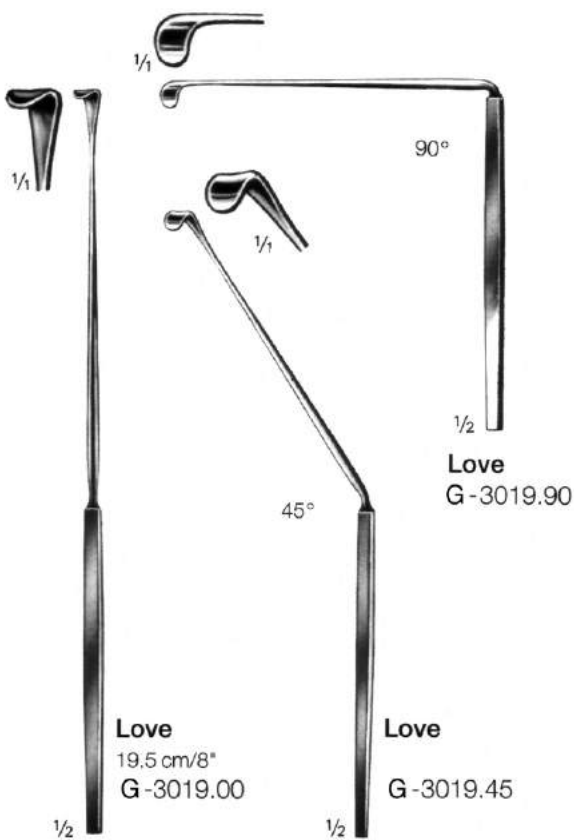

Love
 19.5 cm/8"
 G-3019.00

Love
 G-3019.45

Love
 G-3019.90



Love
 21 cm/8 1/4"
 G-3025.21

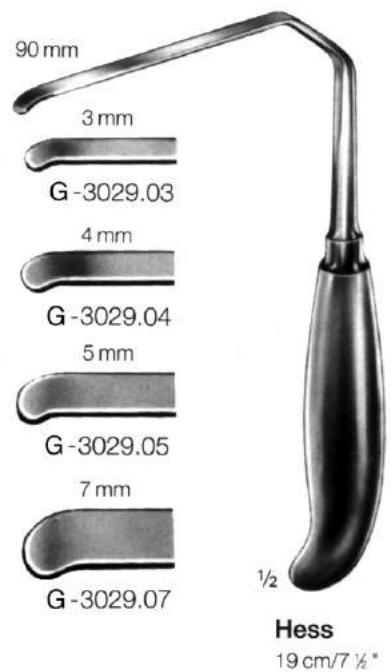

Hess
 19 cm/7 1/2"

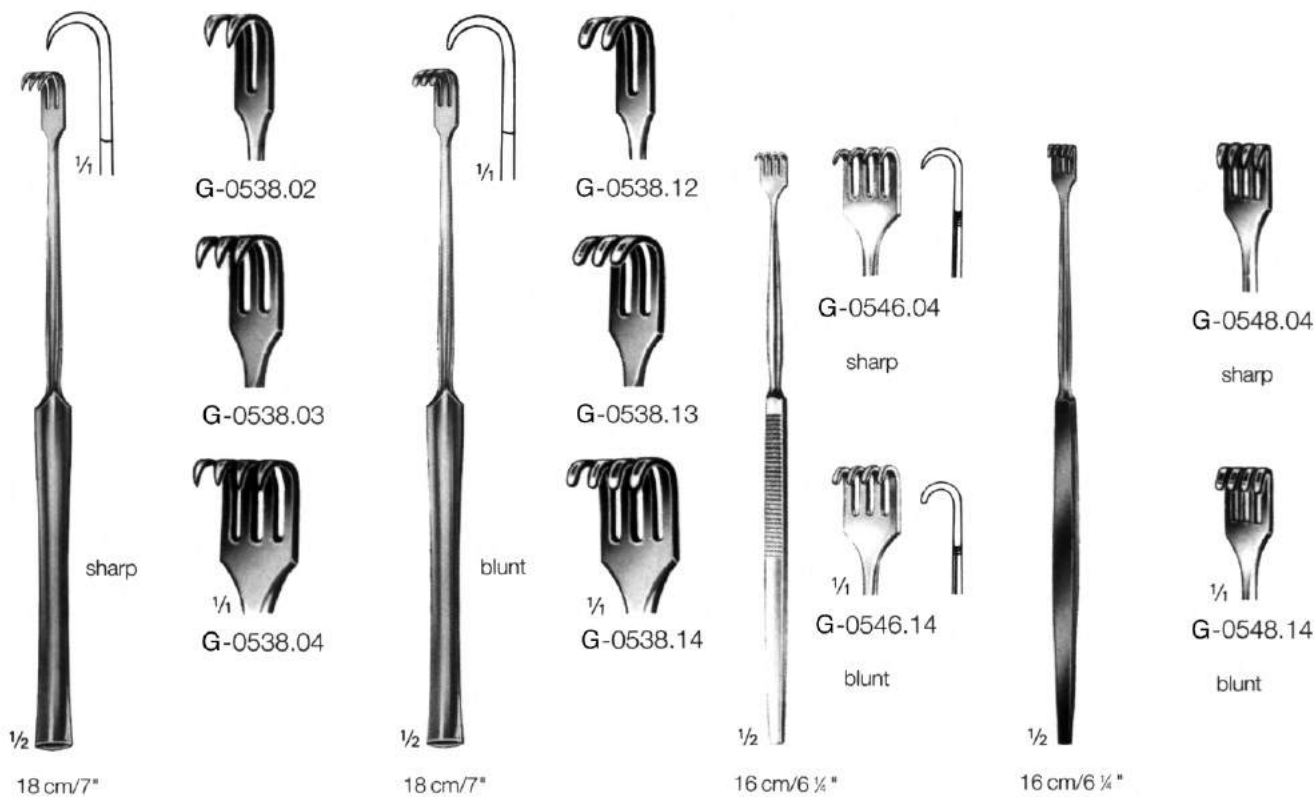
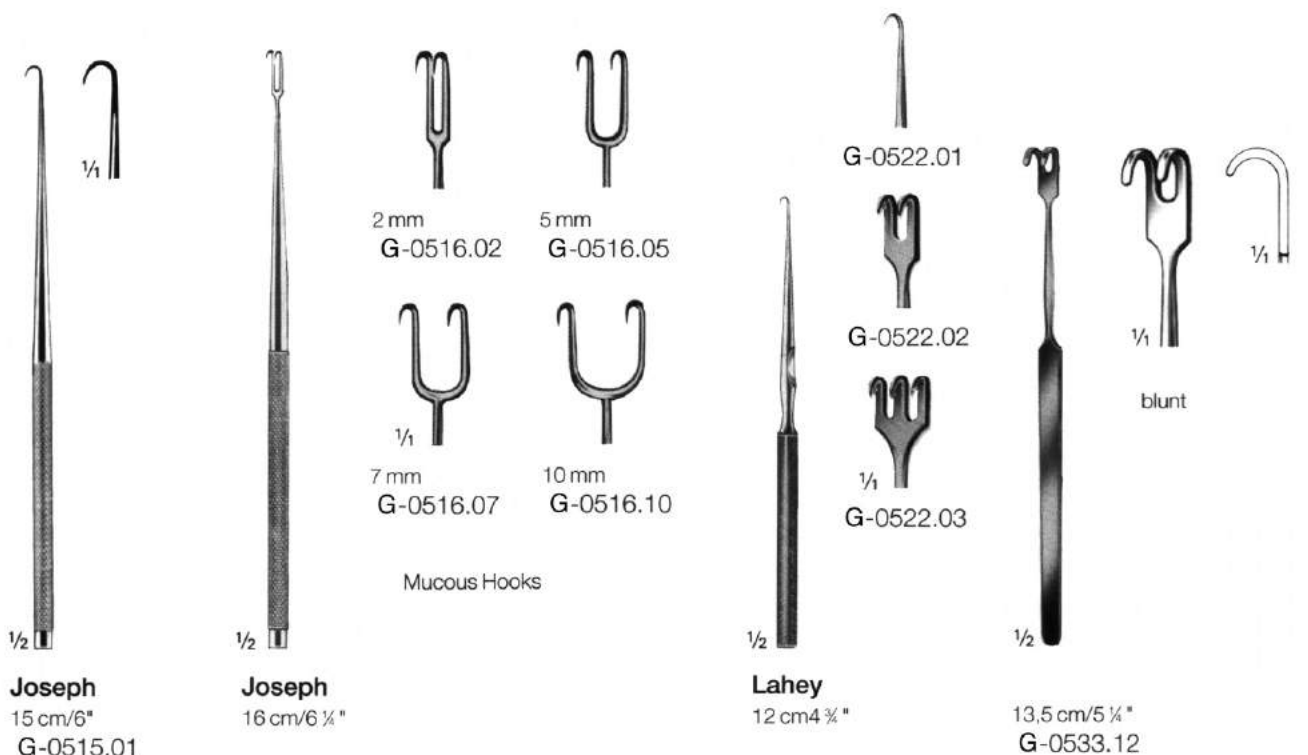

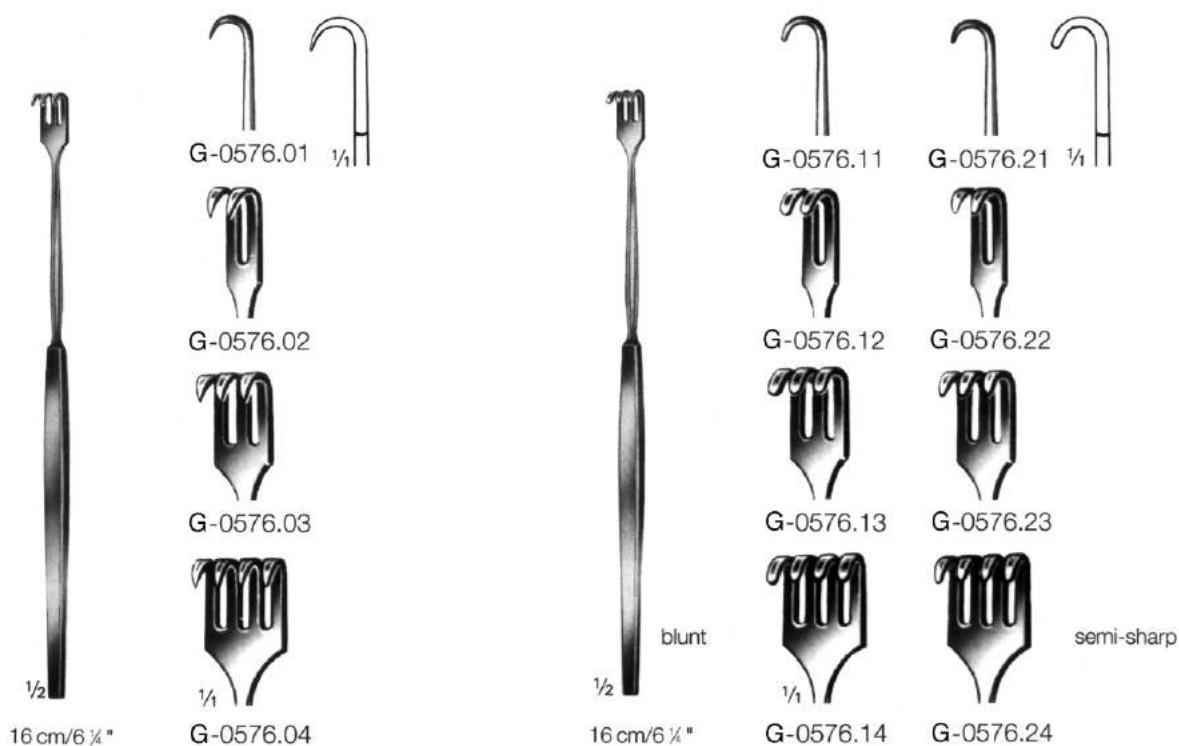
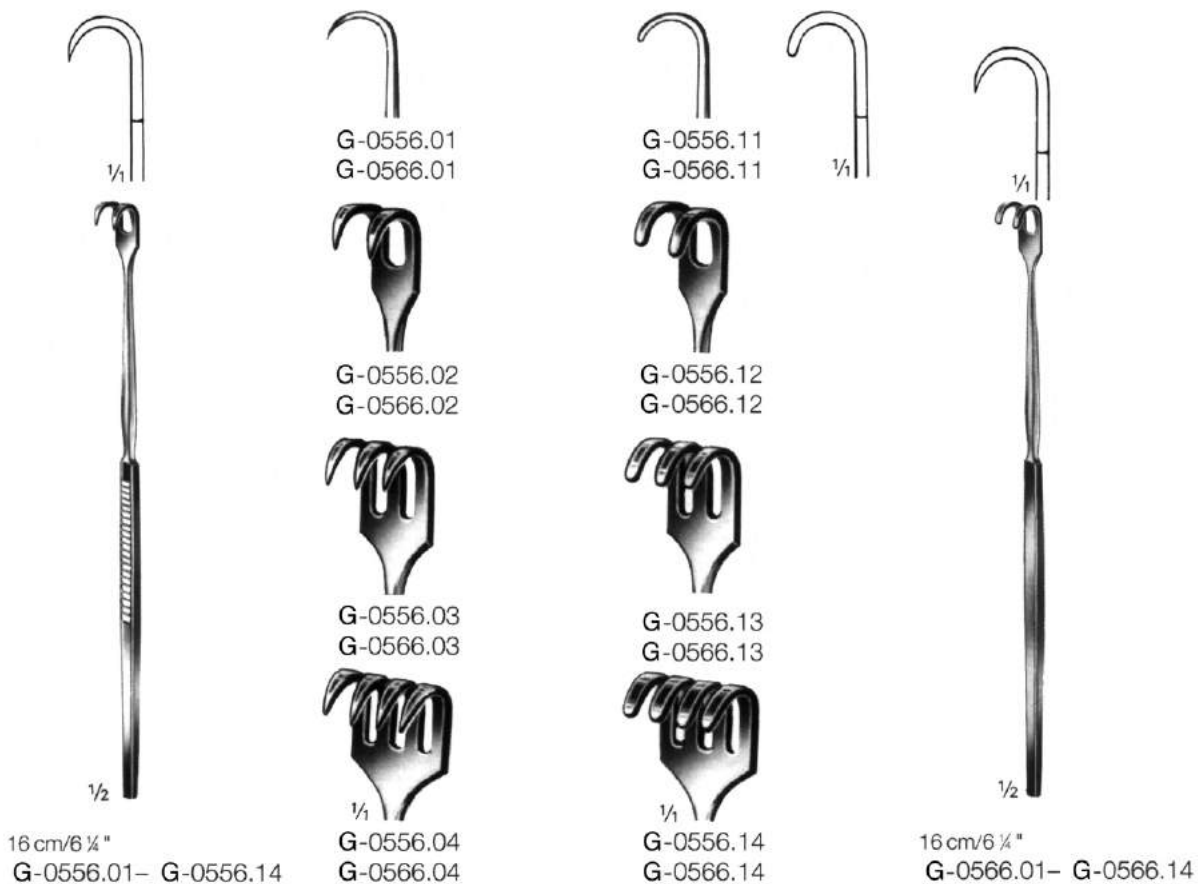

Wound - and trachea retractors
Ecarteurs et crochets à trachée
Separadores y ganchos para la tráquea

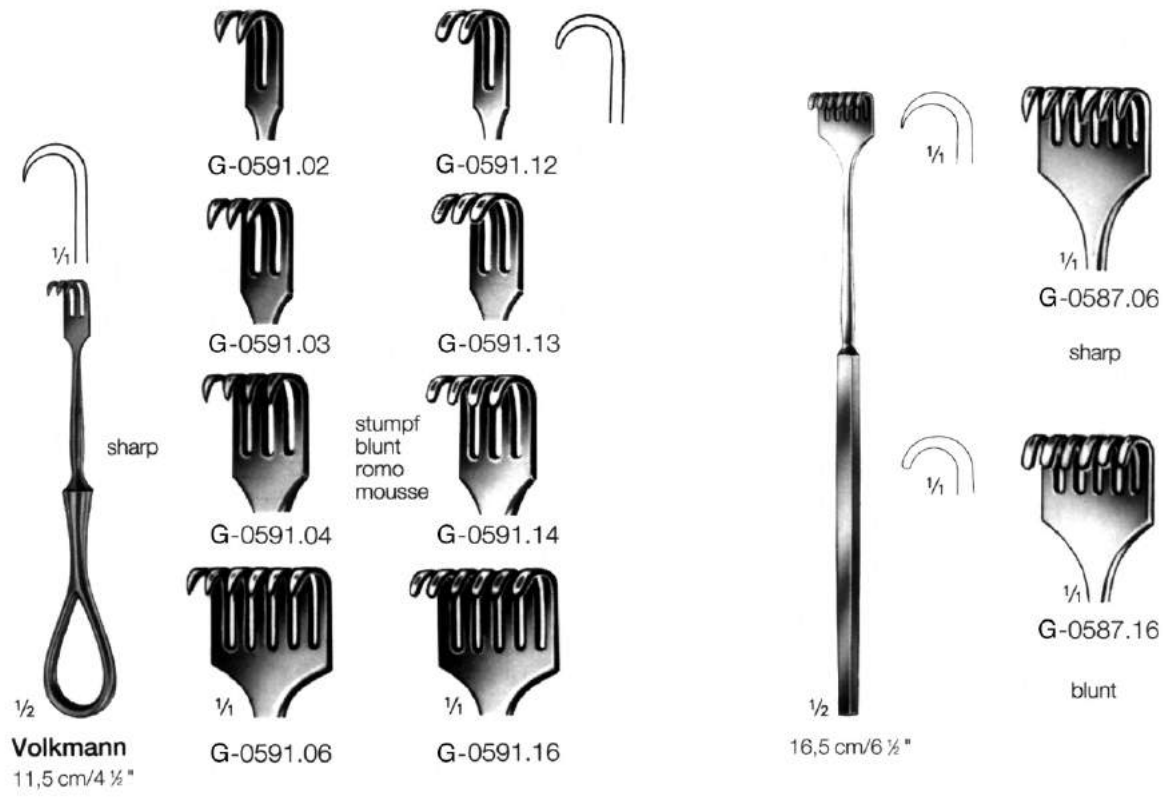
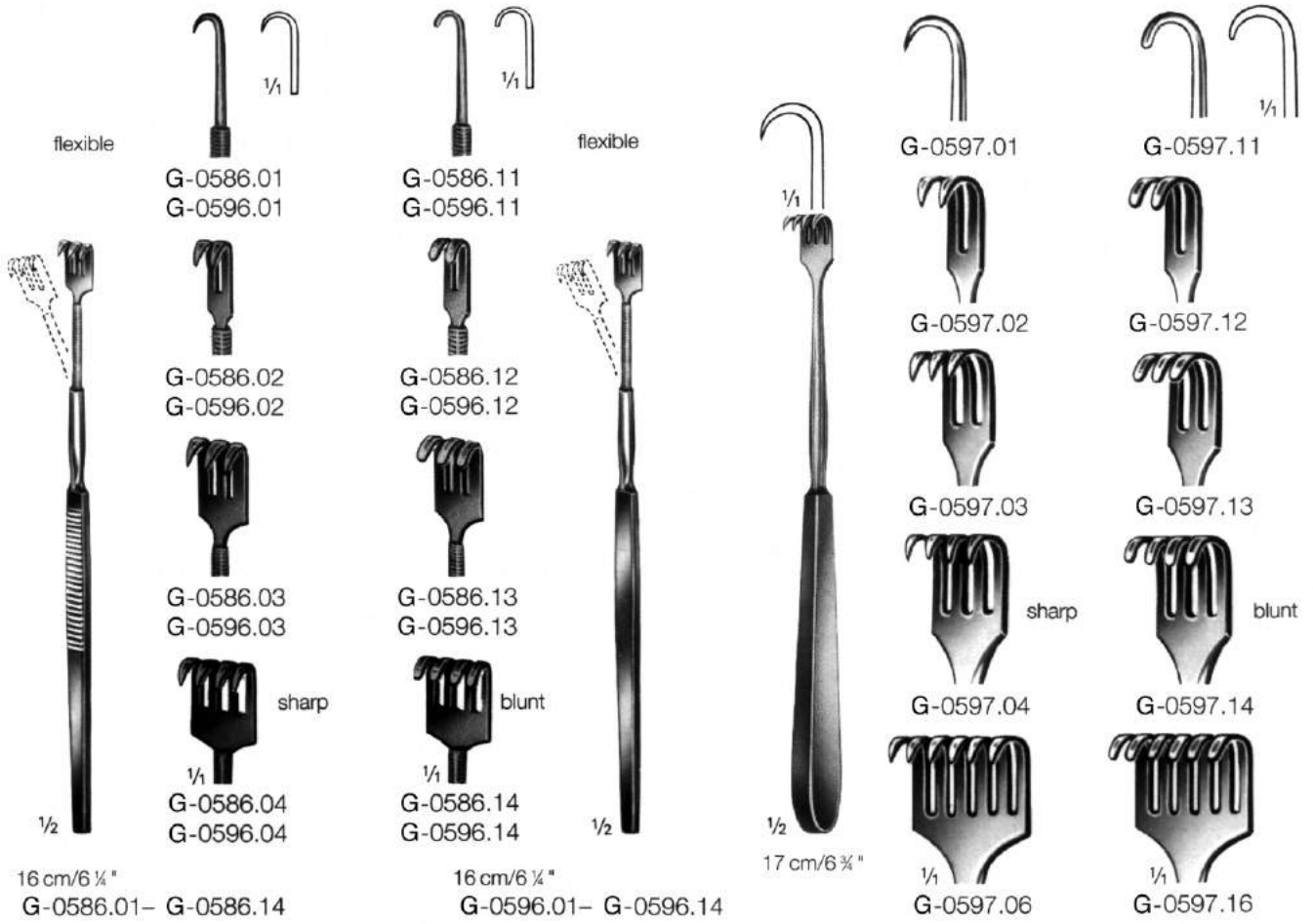

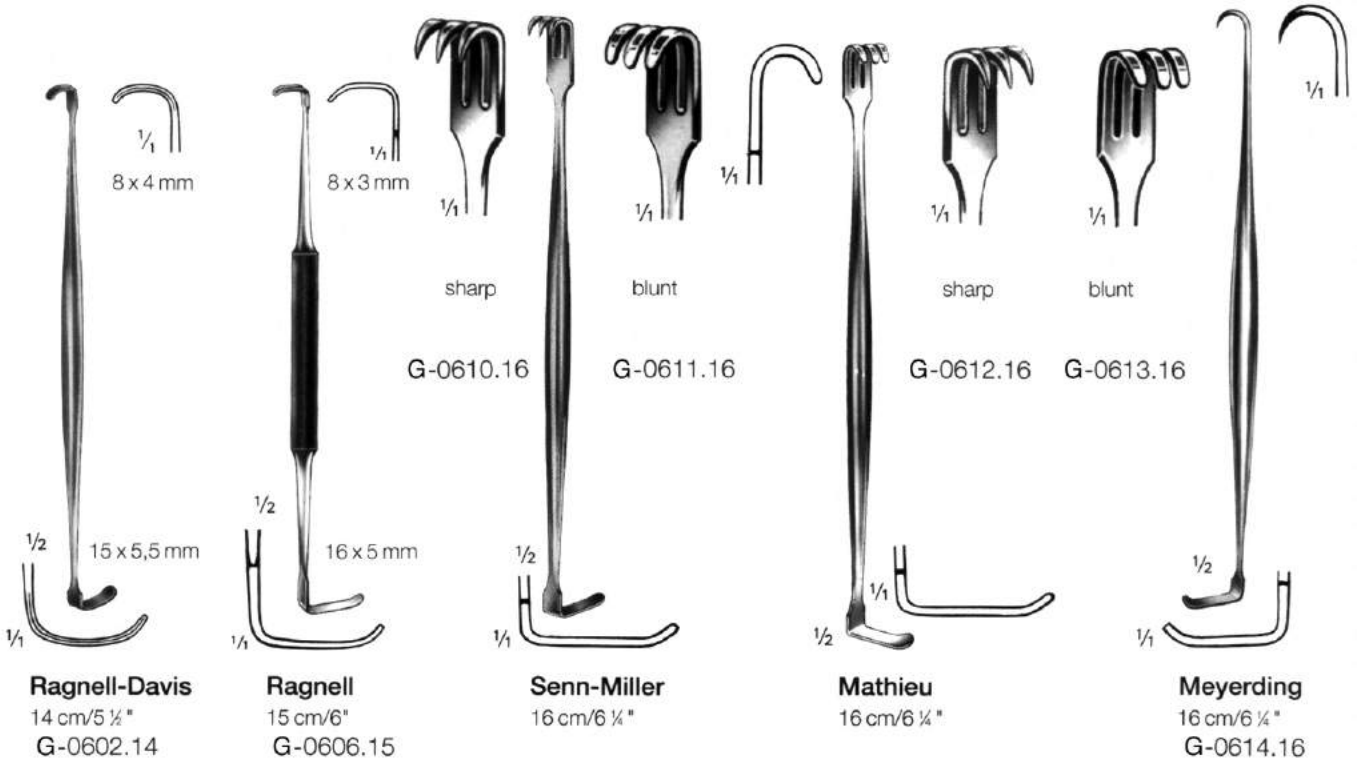

Tendon Sheath Retractors

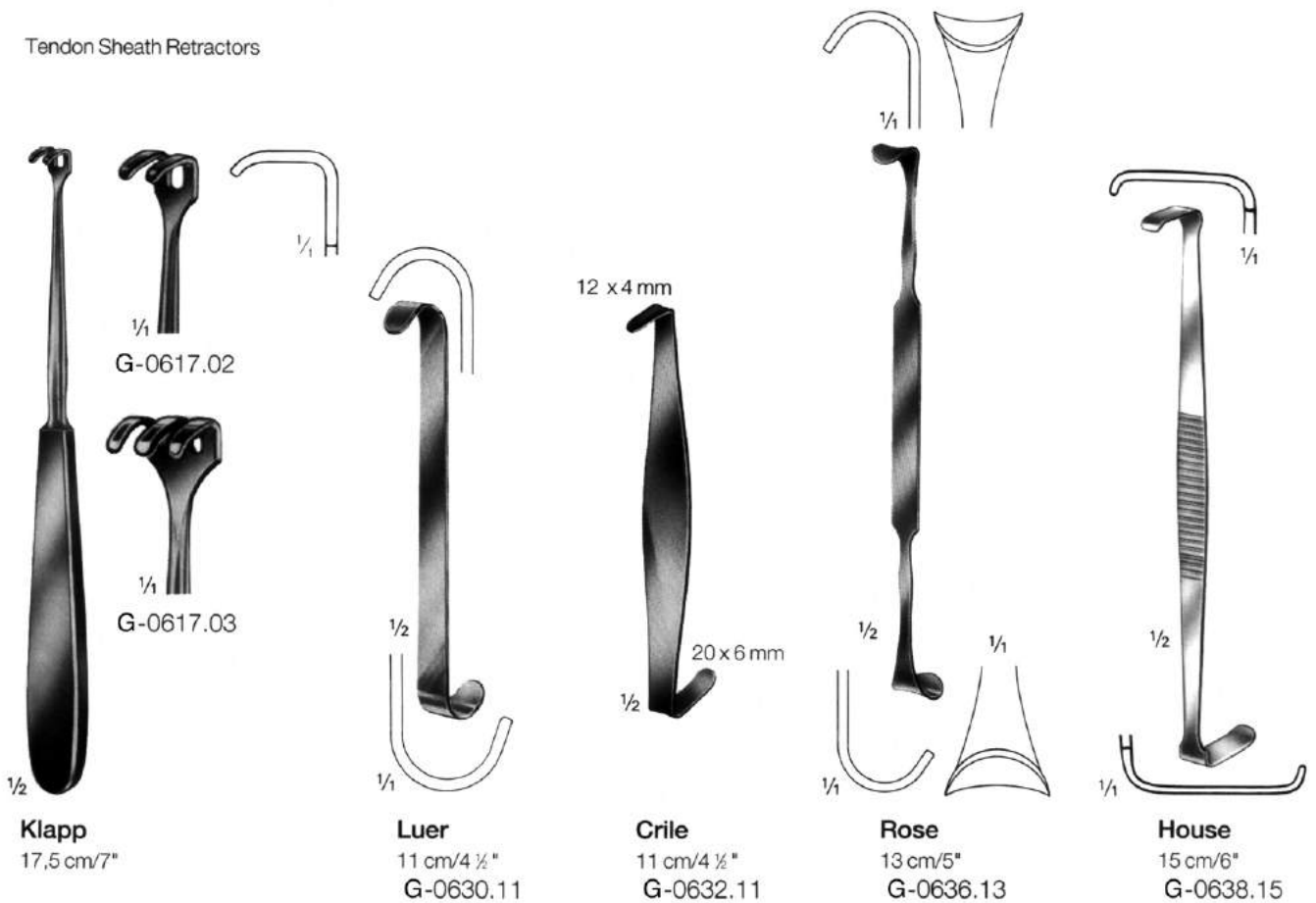

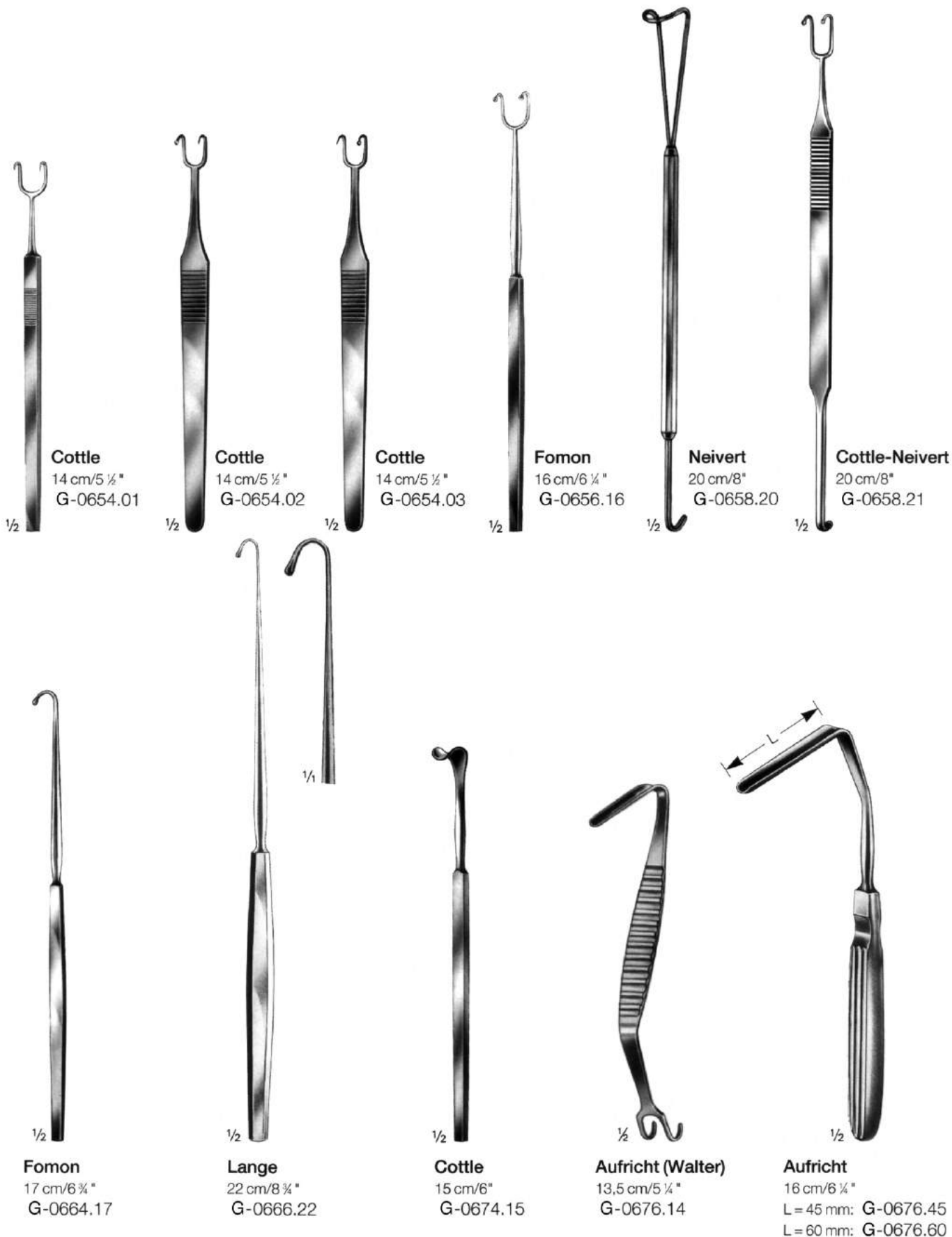

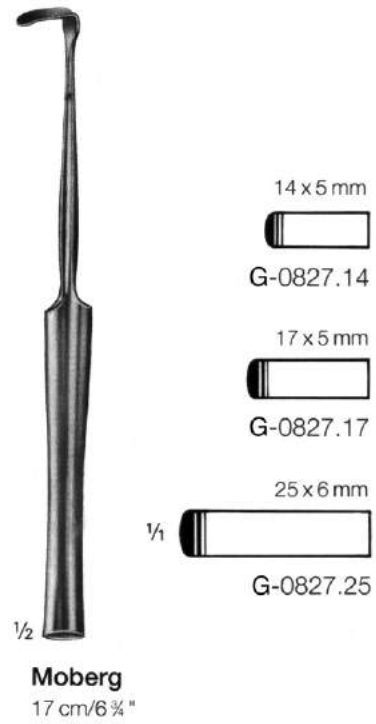
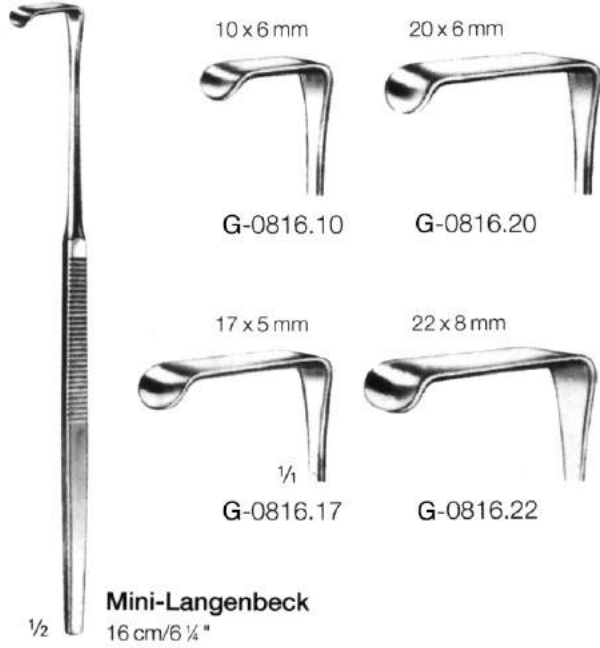



Wound- and Vein Retractors



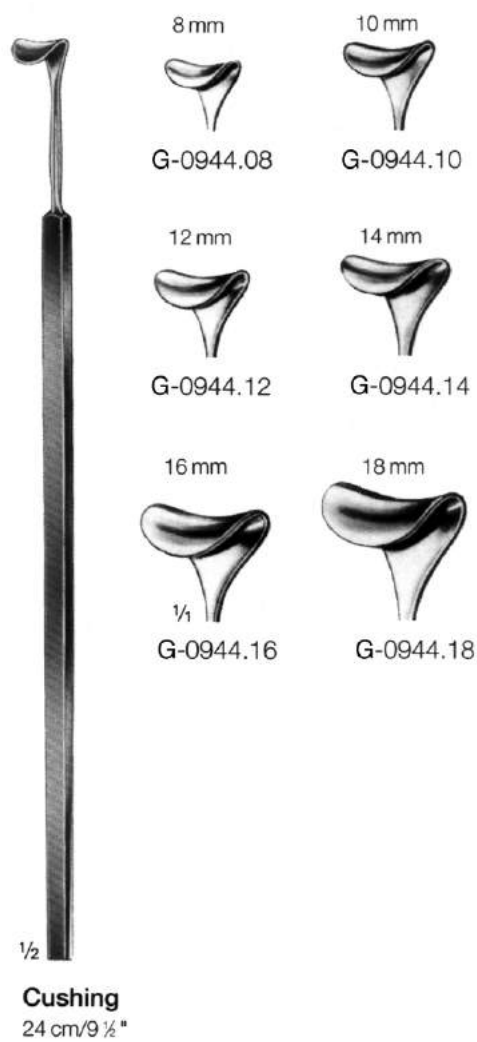
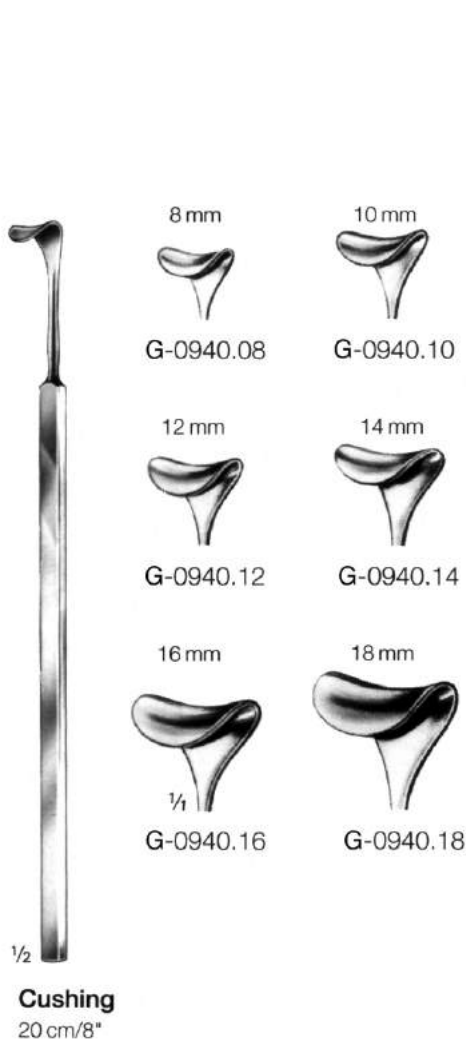



21 cm/8 1/4"



G-1021.04

sharp



G-1021.14

blunt



sharp

1/2

Volkman
23 cm/9"
G-1023.01

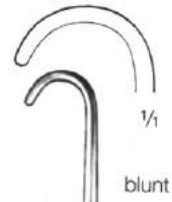

blunt

1/2

Volkman
23 cm/9"
G-1023.11



1/2

Volkman
23 cm/9"



sharp

9 x 8 mm



G-1023.02

9 x 13 mm



G-1023.03

9 x 19 mm



G-1023.04

9 x 29 mm



G-1023.06



blunt



G-1023.12



G-1023.13



G-1023.14



G-1023.16



semi-sharp



G-1023.22











G-1023.23











G-1023.24



G-1023.26

 <p>sharp</p> <p>blunt</p> <p>semi-sharp</p> <p>Volkmann 21,5 cm/8 3/8"</p>		<p>9 x 8 mm</p>  <p>1/2</p> <p>G-1061.02</p>	<p>9 x 13 mm</p>  <p>G-1061.03</p>	<p>9 x 19 mm</p>  <p>G-1061.04</p>	<p>9 x 29 mm</p>  <p>G-1061.06</p>	<p>9 x 40 mm</p>  <p>G-1061.08</p>
		<p>1/2</p> <p>G-1061.12</p>	<p>G-1061.13</p>	<p>G-1061.14</p>	<p>G-1061.16</p>	<p>G-1061.18</p>
		<p>1/2</p> <p>G-1061.22</p>	<p>G-1061.23</p>	<p>G-1061.24</p>	<p>G-1061.26</p>	<p>G-1061.28</p>

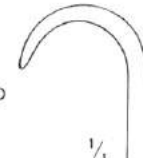
 <p>sharp</p> <p>blunt</p> <p>semi-sharp</p> <p>Volkmann 21,5 cm/8 3/8"</p>		<p>15 x 10 mm</p>  <p>1/2</p> <p>G-1072.02</p>	<p>15 x 15 mm</p>  <p>G-1072.03</p>	<p>15 x 20 mm</p>  <p>G-1072.04</p>	<p>15 x 30 mm</p>  <p>G-1072.06</p>	<p>15 x 40 mm</p>  <p>G-1072.08</p>
		<p>1/2</p> <p>G-1072.12</p>	<p>G-1072.13</p>	<p>G-1072.14</p>	<p>G-1072.16</p>	<p>G-1072.18</p>
		<p>1/2</p> <p>G-1072.22</p>	<p>G-1072.23</p>	<p>G-1072.24</p>	<p>G-1072.26</p>	<p>G-1072.28</p>

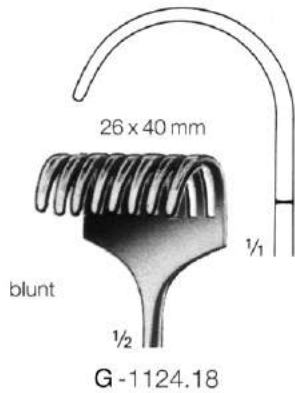
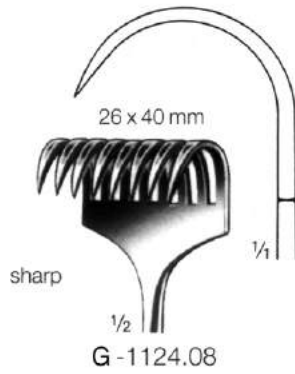
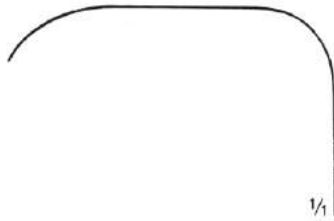
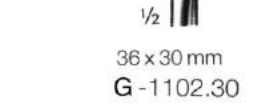



Körte

28 cm/11"
G - 1138.40



25 cm/10"
G - 1145.08



25 cm/10"
G - 1145.16

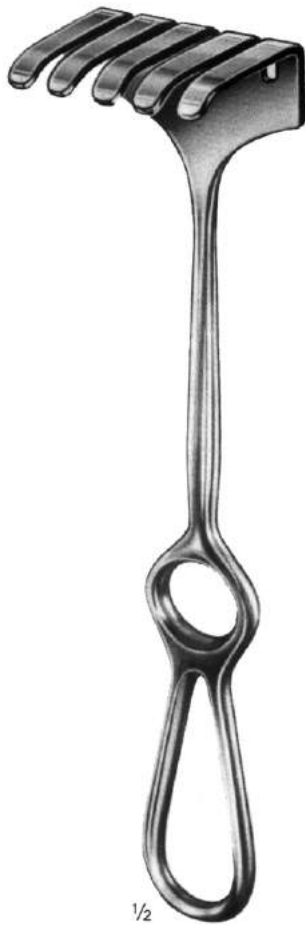

$\frac{1}{2}$
Israel
25 cm/10"

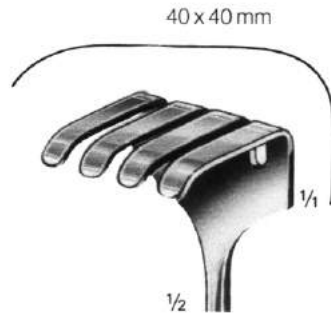

G-1155.40



G-1155.50

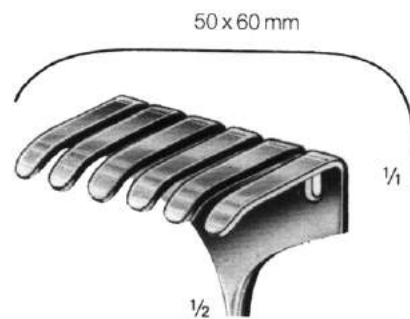

G-1155.60

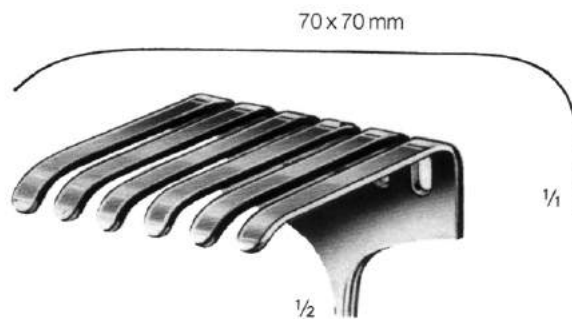

G-1155.70

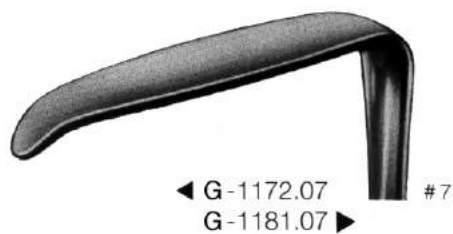

1/2
Langenbeck
22 cm/8 1/2"
G-1172.##



1/2
Langenbeck
21 cm/8 1/4"
G-1181.##

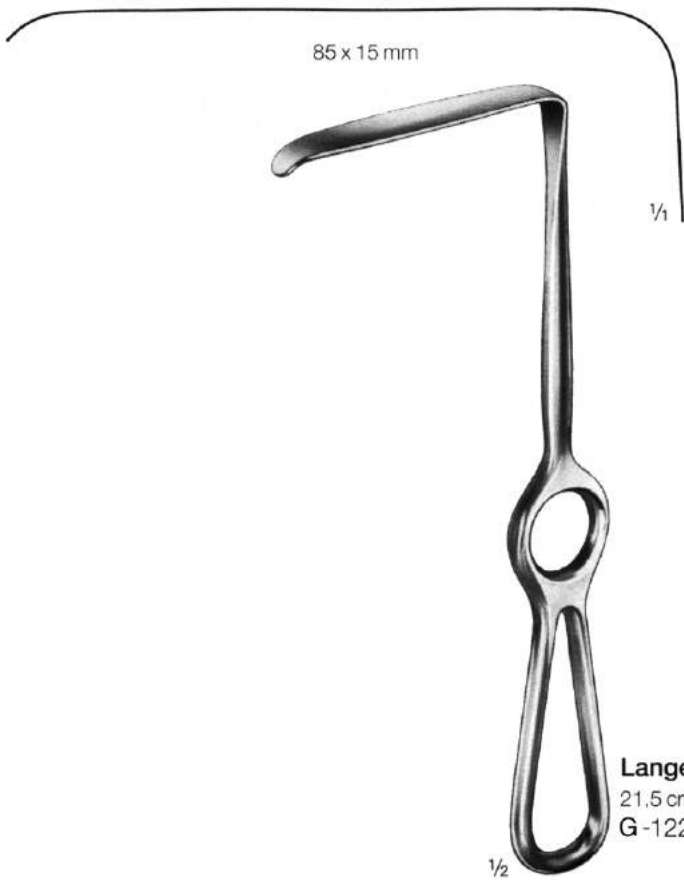
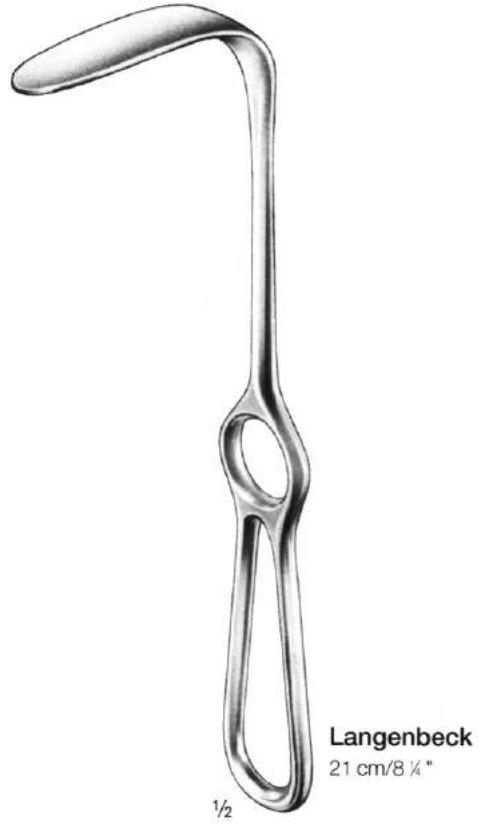
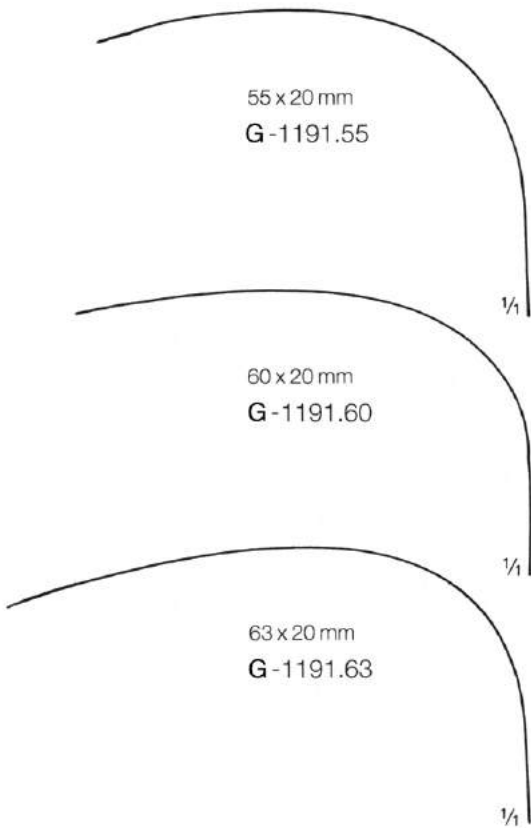

Abdominal Retractors écarteurs abdominaux Los retractoros abdominales



Kocher
23 cm/9"

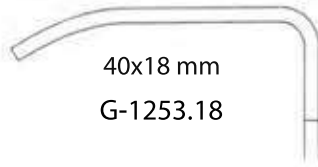

40x18 mm
G-1253.18

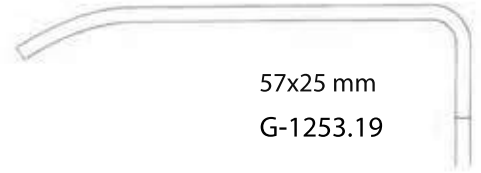

57x25 mm
G-1253.19

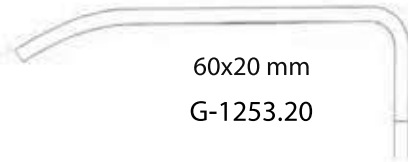

60x20 mm
G-1253.20

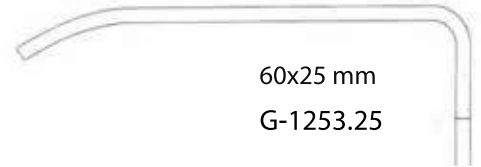

60x25 mm
G-1253.25

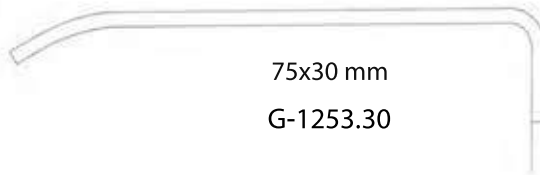

75x30 mm
G-1253.30

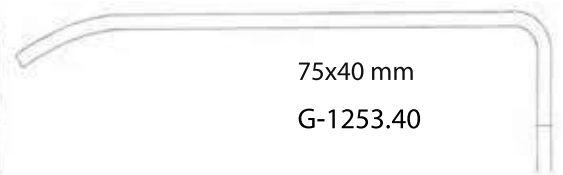

75x40 mm
G-1253.40

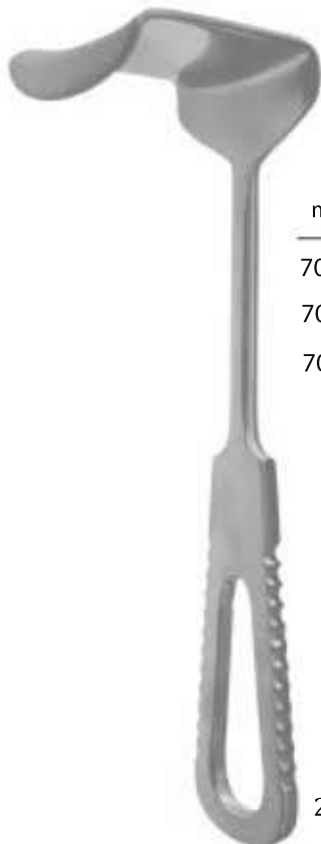

Morris
24 cm/9.5"

mm	
70x40	G-1264.40
70x50	G-1264.50
70x65	G-1264.65

mm	
50x38	G-1266.38
50x50	G-1266.50
50x63	G-1266.63

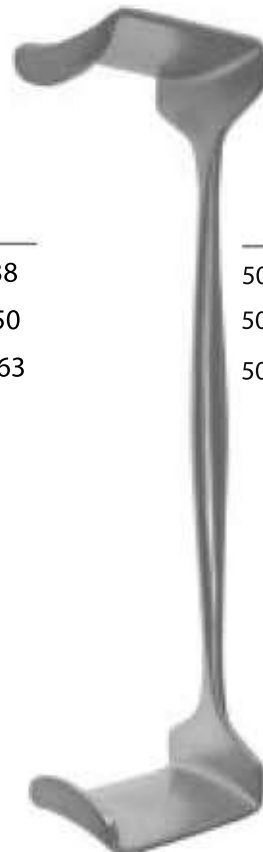

Morris
24 cm/9.5"

mm	
50x32/51x38	G-1260.38
50x44/51x50	G-1260.50
50x57/51x63	G-1260.63

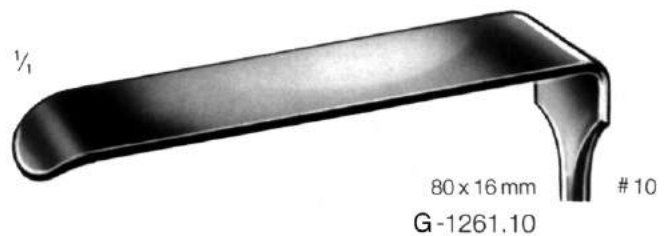
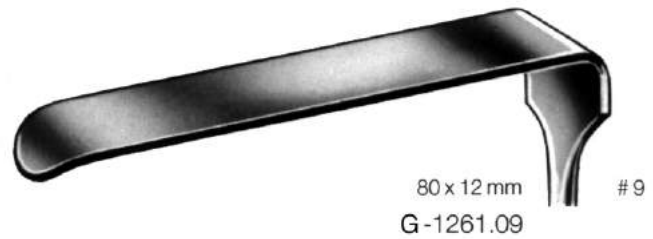
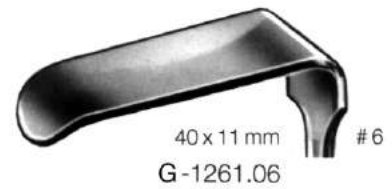

$\frac{1}{2}$
Kocher-Langenbeck
21,5 cm/8 $\frac{1}{2}$ "

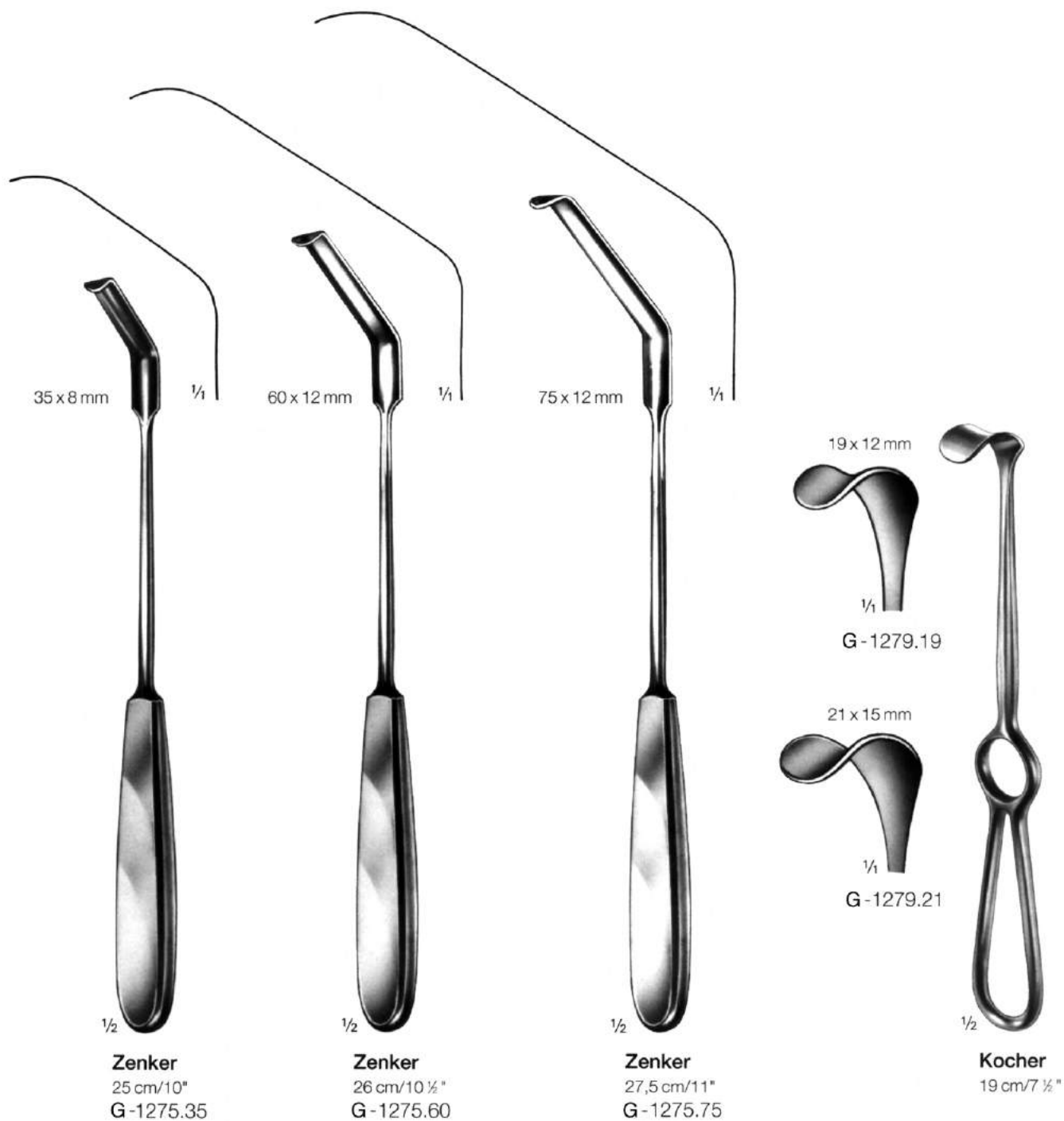

20 x 14 mm



20 x 19 mm

1/2

20 cm/8"
G-2002.20

1/2

Kocher
22 cm/8 3/4"
G-2006.10 = 40 x 10 mm
G-2006.15 = 40 x 15 mm
G-2006.20 = 40 x 20 mm

1/2

Middeldorpf
G-2010.##

14 x 17 mm



1/2

21,5 cm/8 1/2"
◀ G-2010.14
G-2012.14 ▶

20 x 22 mm



1/2

22 cm/8 3/4"
◀ G-2010.20
G-2012.20 ▶

26 x 30 mm



1/2

23,5 cm/9 1/4"
◀ G-2010.26
G-2012.26 ▶

1/2

Middeldorpf
G-2012.##



Hösel
25 cm/10"

1/2



60 x 20 mm
G-2100.62

1/4



80 x 30 mm
G-2100.83

1/4



100 x 30 mm
G-2101.03

1/4



120 x 30 mm
G-2101.23

1/4



140 x 30 mm
G-2101.43

1/4



140 x 40 mm
G-2101.44

1/4

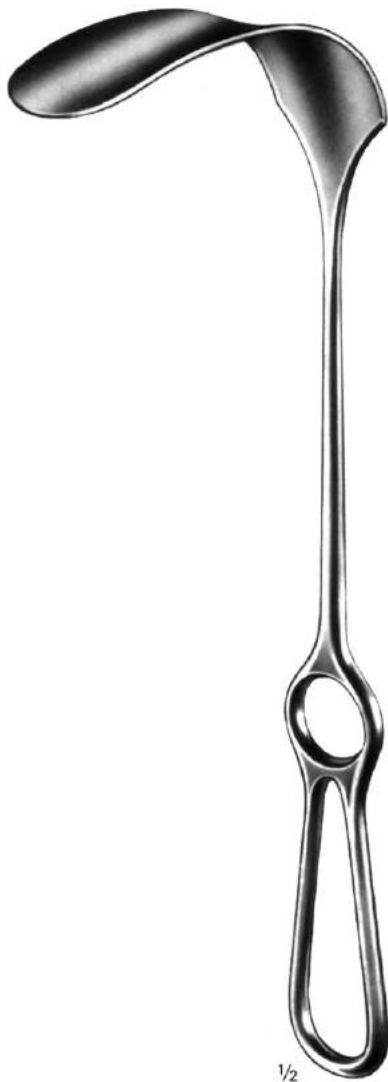

Kocher
28 cm/11"



G-2108.15



G-2108.20

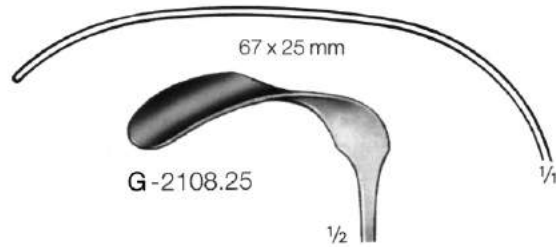

G-2108.25

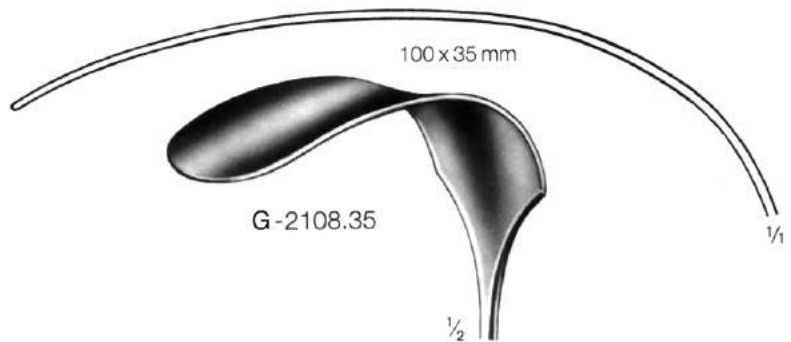

G-2108.35

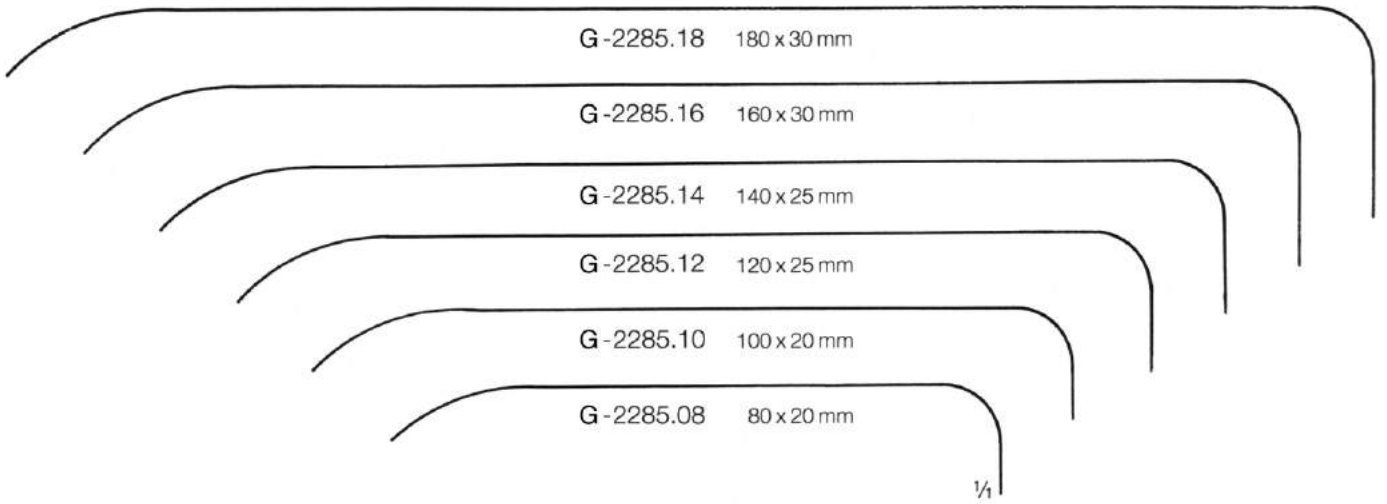

Brunner
24 cm/9 1/2"
G -2274.25



Brunner
25 cm/10"

G-2286.18 180 x 30 mm

G-2286.16 160 x 30 mm

G-2286.14 140 x 30 mm

G-2286.13 130 x 30 mm

G-2286.12 120 x 25 mm

G-2286.10 100 x 25 mm

G-2286.08 80 x 20 mm



$\frac{1}{2}$

Brunner
 25 cm/10"

$\frac{1}{1}$



50 x 16 mm
G-2392.50

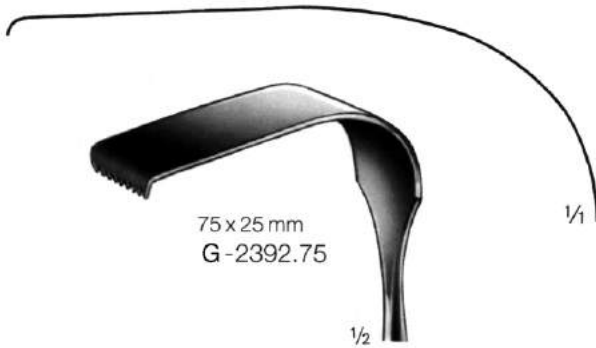

75 x 25 mm
G-2392.75



90 x 50 mm
G-2392.90

Meyering
22,5 cm/9"

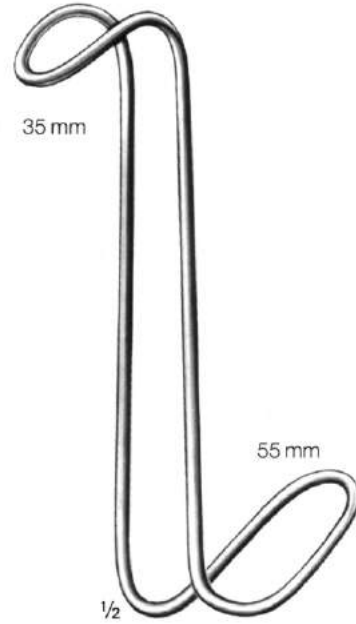

35 mm

55 mm

1/2

Collin-Hartmann
16 cm/6 1/4"
G-2395.16



30 x 31 mm

1/4

37 x 40 mm

1/4

1/2

Goelet
19 cm/7 1/2"
G-2500.19

Double Ended Retractors Retractors Double Ended Los retractoros de dos extremos

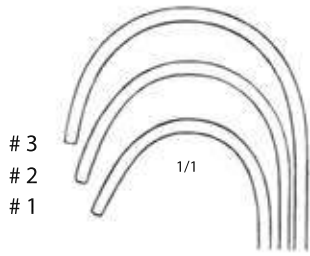

- G-2516.01 #1 20 x 22 mm
25 x 28 mm
- G-2516.02 #2 23 x 26 mm
29 x 38 mm
- G-2516.03 #3 29 x 29 mm
34 x 44 mm

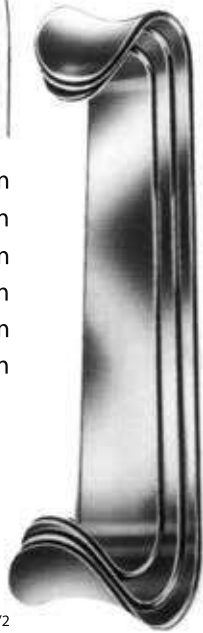

Set of 3
Roux
16.5 cm/6.5"
G-2516.00

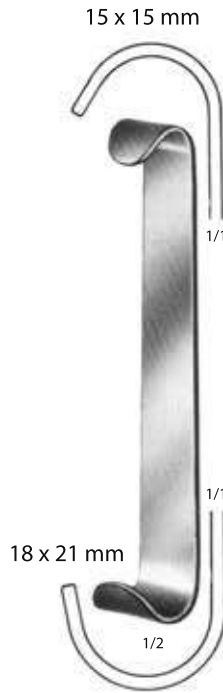

Baby-Roux
13 cm/5"
G-2516.13



Roux
16.5 cm/6.5"
G-2516.16



Roux
18.5 cm/7.25"
G-2516.18

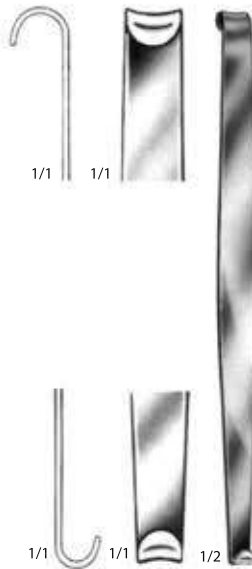

Mini-Roux
15 cm/6"
G-2516.25



Roux-Magnus
15 cm/6"
G-2516.35



Roux-Magnus
16 cm/6.25"
G-2516.36



Roux-Magnus
17 cm/6.75"
G-2516.37

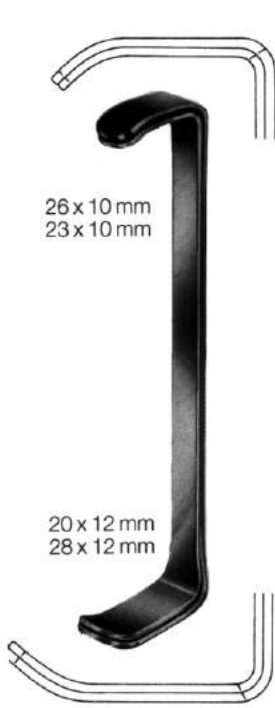

26 x 10 mm
23 x 10 mm

20 x 12 mm
28 x 12 mm

Farabeuf
Set

13 cm/5 1/8"
G - 2543.00

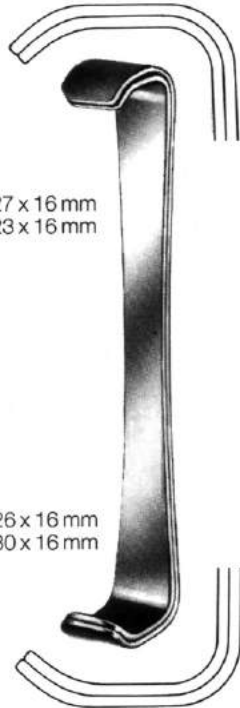

27 x 16 mm
23 x 16 mm

26 x 16 mm
30 x 16 mm

Farabeuf
Set

15 cm/6"
G - 2545.00

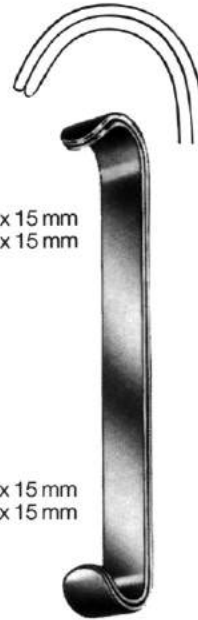

22 x 15 mm
19 x 15 mm

19 x 15 mm
22 x 15 mm

Parker
Set

13,5 cm/5 1/8"
G - 2563.00



27 x 25 mm
24 x 25 mm

26 x 25 mm
29 x 25 mm

Parker
Set

18 cm/7"
G - 2568.00



Parker-Mott
16 cm/6 1/4" Satz - Set
G - 2556.00

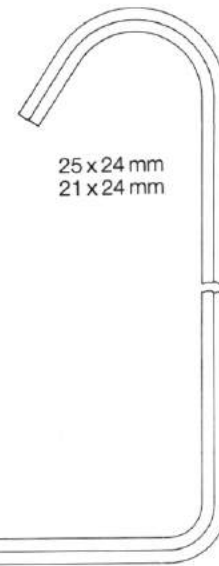

25 x 24 mm
21 x 24 mm

68 x 24 mm
74 x 24 mm

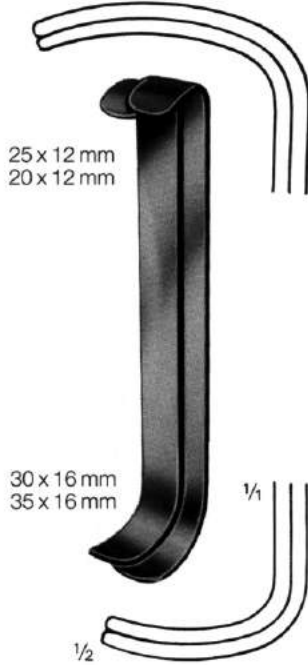

Collin

Set
16,5 cm/6 1/2"
G -2576.00



Mayo-Collins

Set
15 cm/6"
G -2585.00



Mathieu

Set
19 cm/7 1/2"
G -2589.00

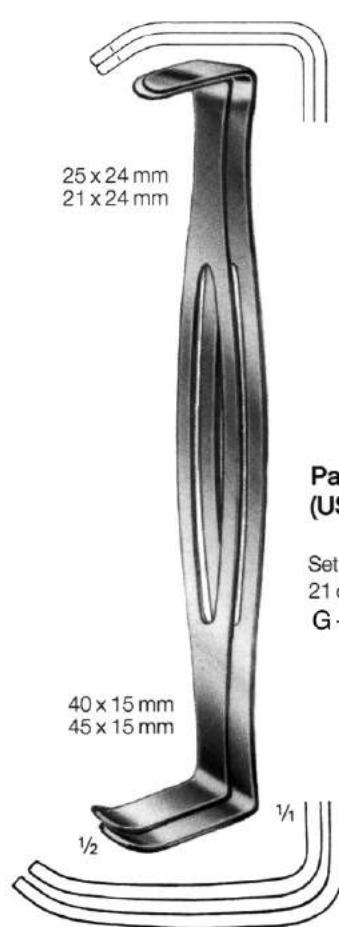

**Parker-Langenbeck
(US Army)**

Set
21 cm/8 1/4"
G -2591.00

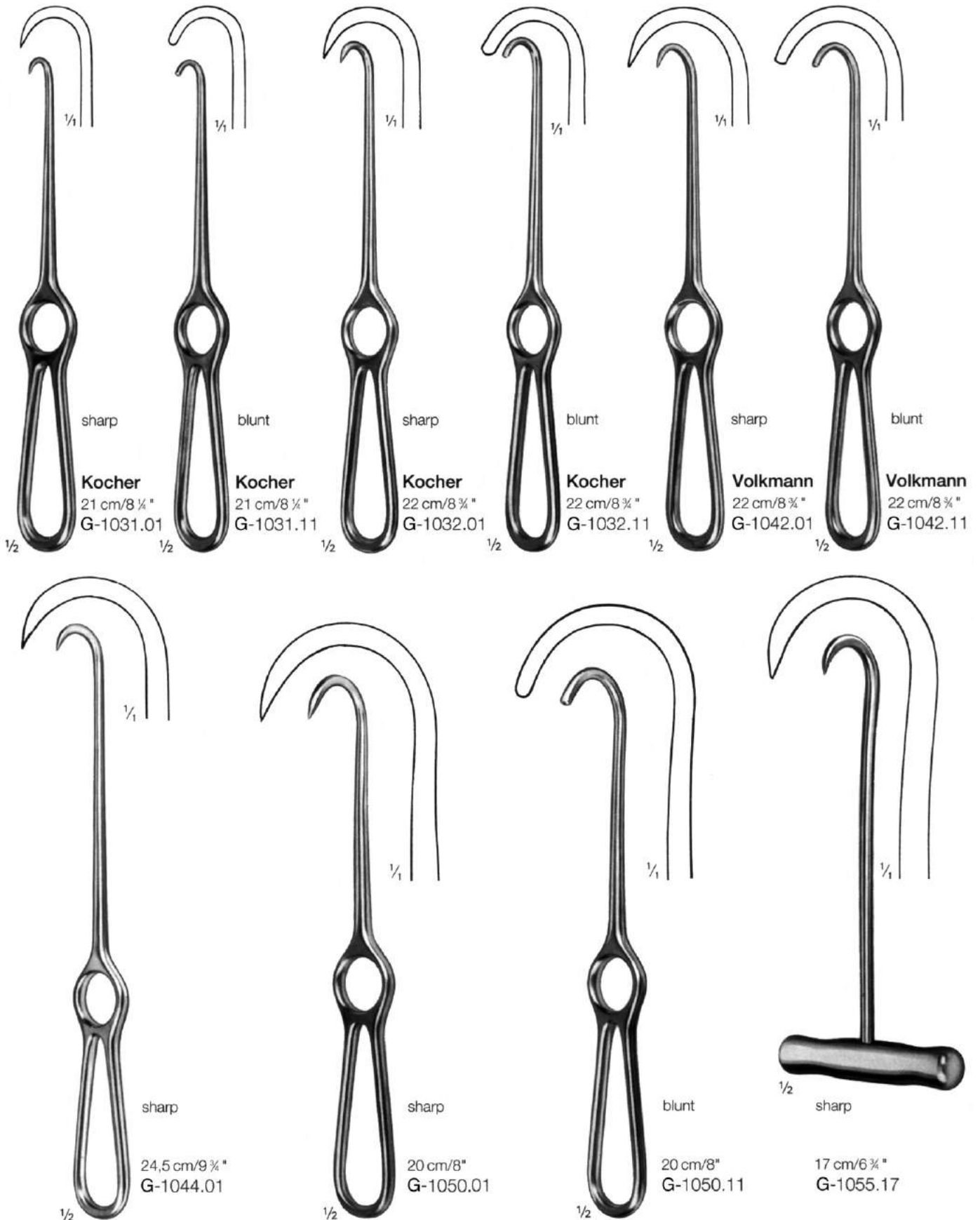

Wound and knee retractors
Ecarteurs et écarteurs pour genou
Separadores y separadores para rodilla

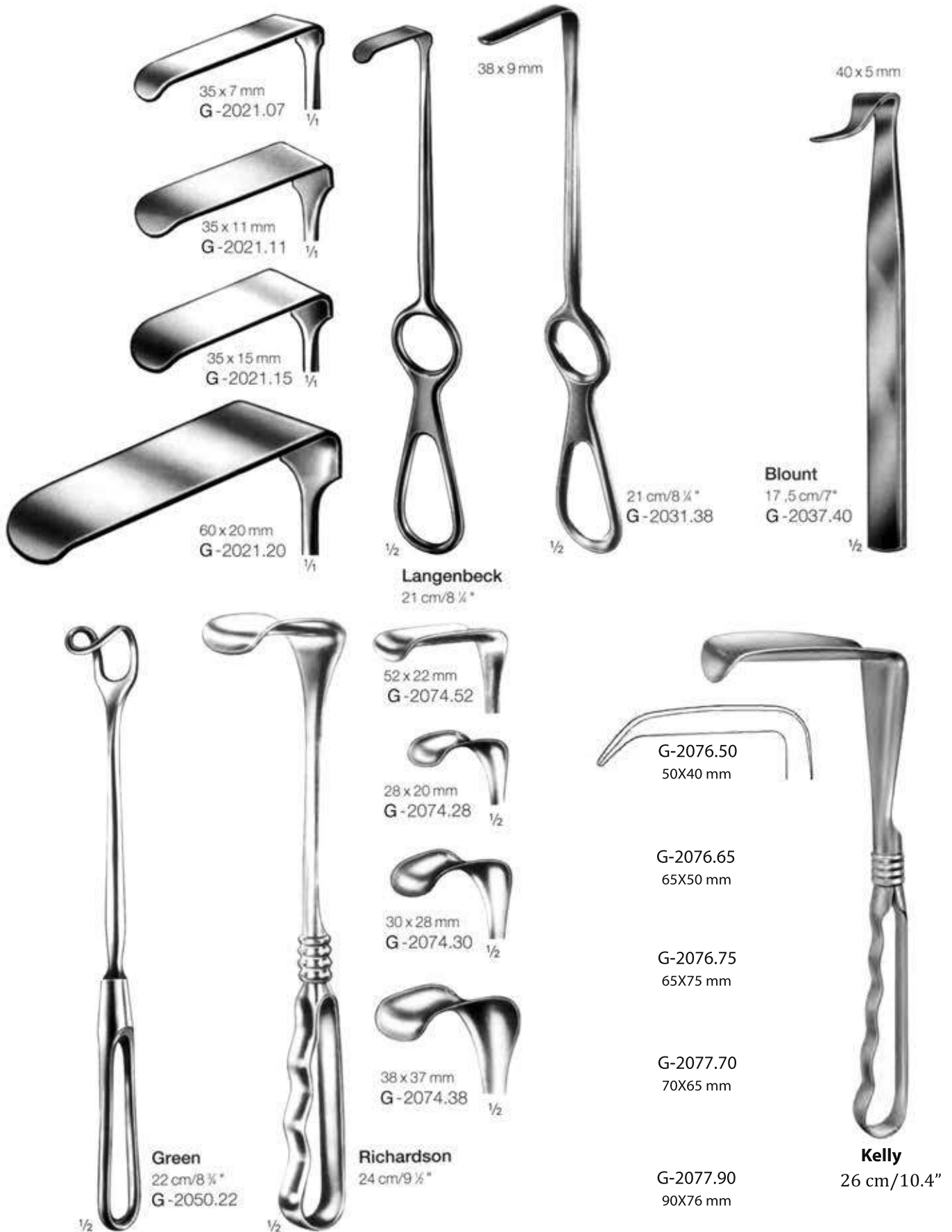







19 mm

Fig. 000
Deaver
 18 cm/7"
 G-2240.01



22 mm

Fig. 00
Deaver
 21.5 cm/8.5"
 G-2240.02



25 mm

Fig. 0
Deaver
 23 cm/9"
 G-2240.03



25 mm

Fig. 1
Deaver
 30 cm/12"
 G-2240.04



25 mm

Fig. 2
Deaver
 33 cm/13"
 G-2240.05



25 mm

Fig. 2.5
Deaver
 36 cm/14"
 G-2240.06

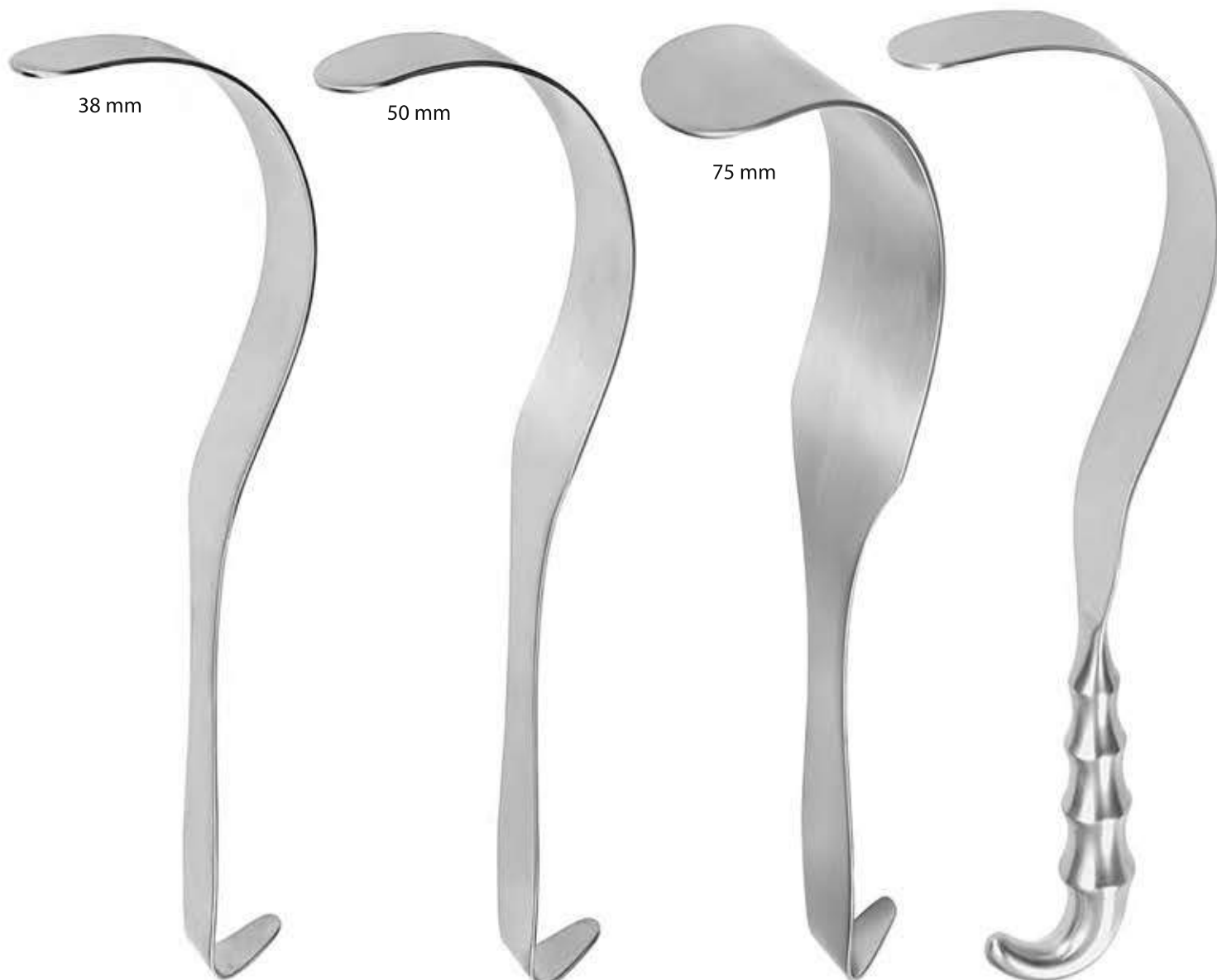
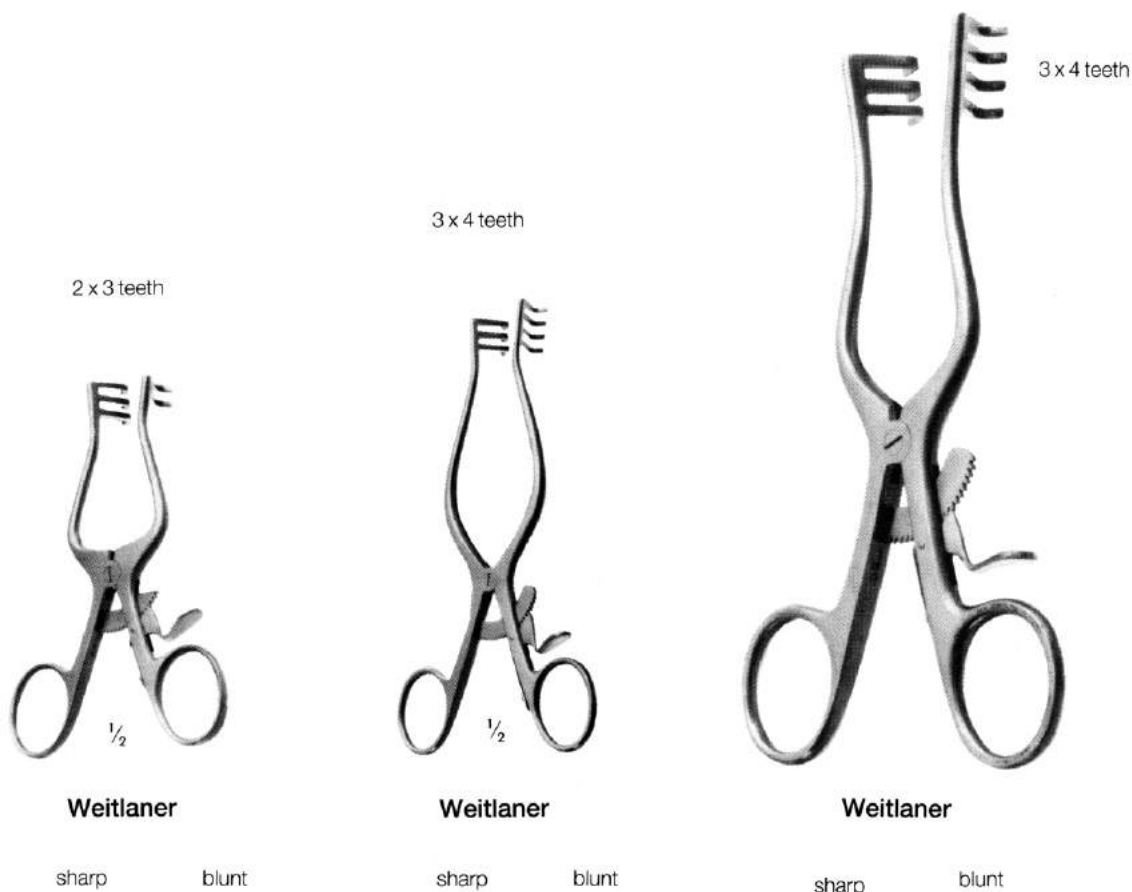
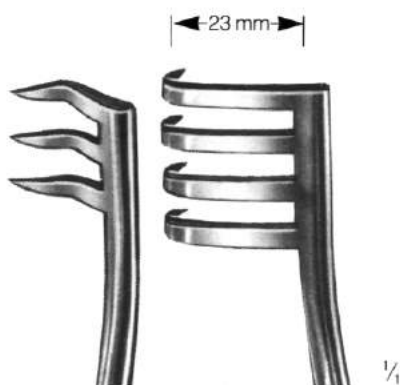

Fig. 3	Fig. 4	Fig. 5		Deaver Grip
G-2240.07	G-2240.08	G-2240.09	30 cm/12"	30 cm/12"
	Deaver		mm	
			25	G-2241.25
			38	G-2241.38
			50	G-2241.50
			75	G-2241.75
			100	G-2242.10



cm	inch				
10,5	4 ¼	G-5211.23	G-5211.43		
13	5			G-5213.34	G-5213.44
16,5	6 ½				G-5216.34 G-5216.44
20	8				G-5220.34 G-5220.44

3 x 4 teeth, sharp



G-5224.34

3 x 4 teeth, blunt



G-5224.44

5 x 6 teeth, sharp

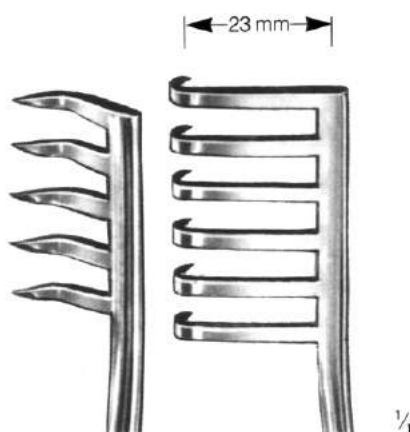

G-5224.56

5 x 6 teeth, blunt

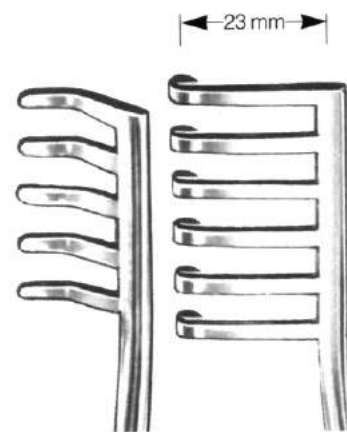

G-5224.76

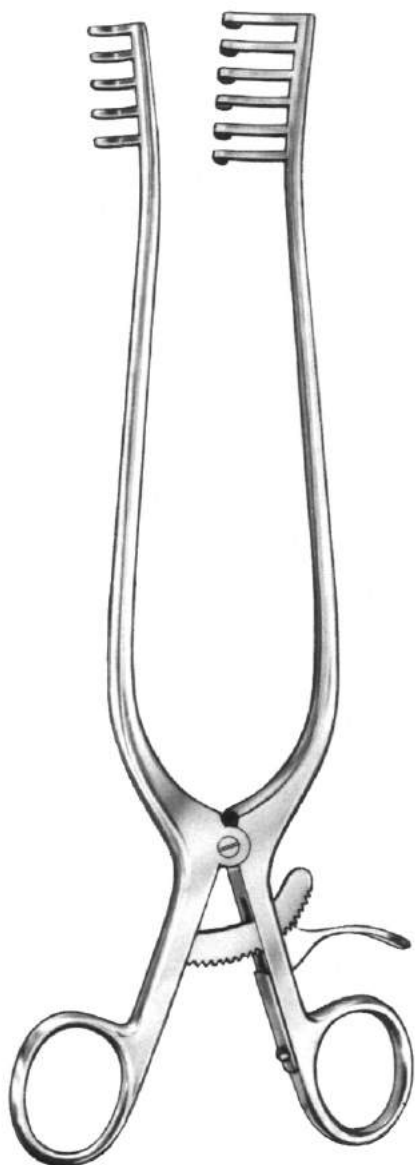

Weitlaner

24 cm/9 1/2"

sharp

3 x 4 teeth

blunt

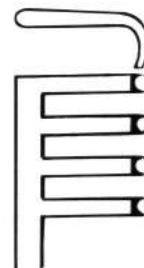
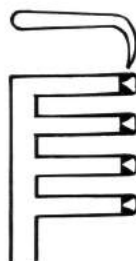

G-5263.34 **Adson-Baby (Cone)** G-5263.44
(Beckmann-Weitlaner)
 13 cm/5"



G-5266.34 **Adson-Baby (Cone)** G-5266.44
(Beckmann-Weitlaner)
 16 cm/6 1/2"

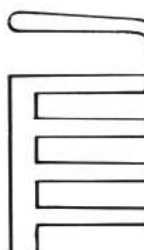

G-5270.34 **Adson-Baby (Cone)** G-5270.44
(Beckmann-Weitlaner)
 20 cm/8"



G-5274.34 **Adson**
 24 cm/9 1/2"

G-5274.44

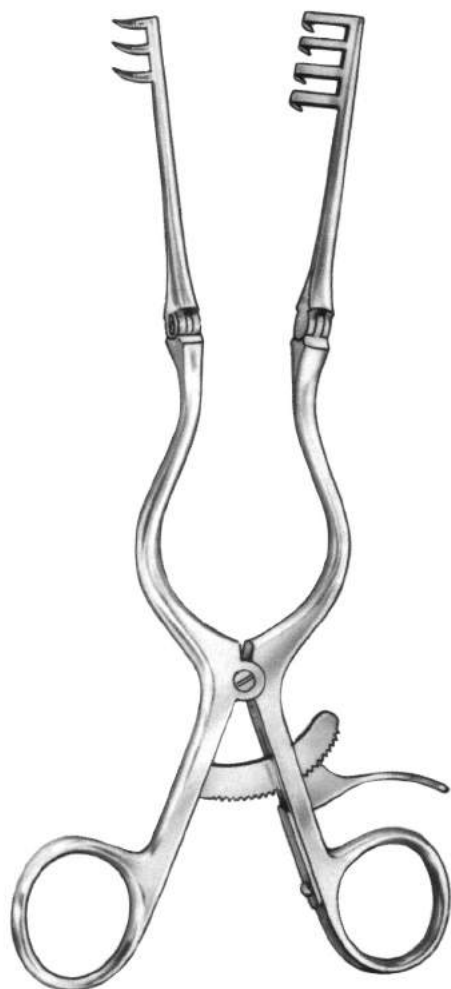

4 x 4 teeth sharp



Jansen
 10 cm/4"
 G-5310.11

4 x 4 teeth blunt

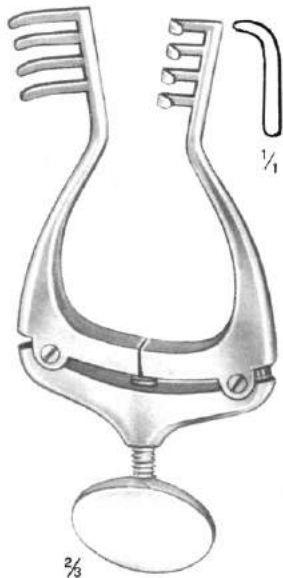

Jansen
 10 cm/4"
 G-5311.11

3 x 3 teeth sharp



Jansen
 10,5 cm/4 1/4"
 G-5312.11

3 x 3 teeth blunt



Jansen
 10,5 cm/4 1/4"
 G-5313.11

sharp



Plester
 13 cm/5"
 G-5363.22

blunt

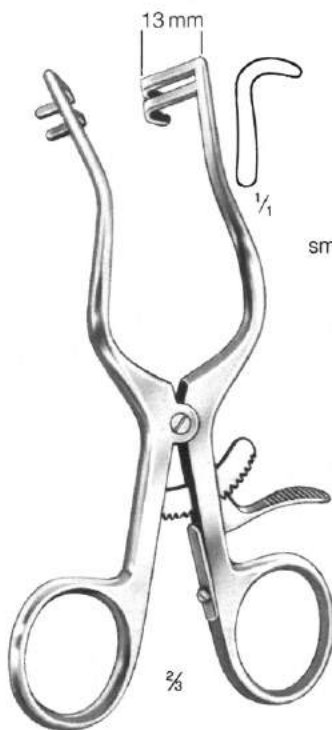

Plester
 13 cm/5"
 G-5363.32

blunt

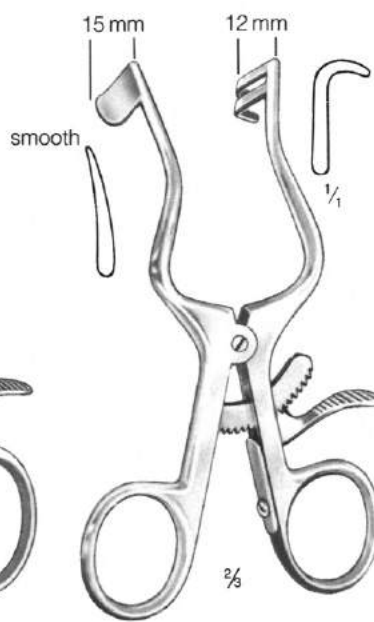

Plester
 11 cm/4 1/4"
 G-5371.02

blunt



Plester
 11 cm/4 1/4"
 G-5371.01

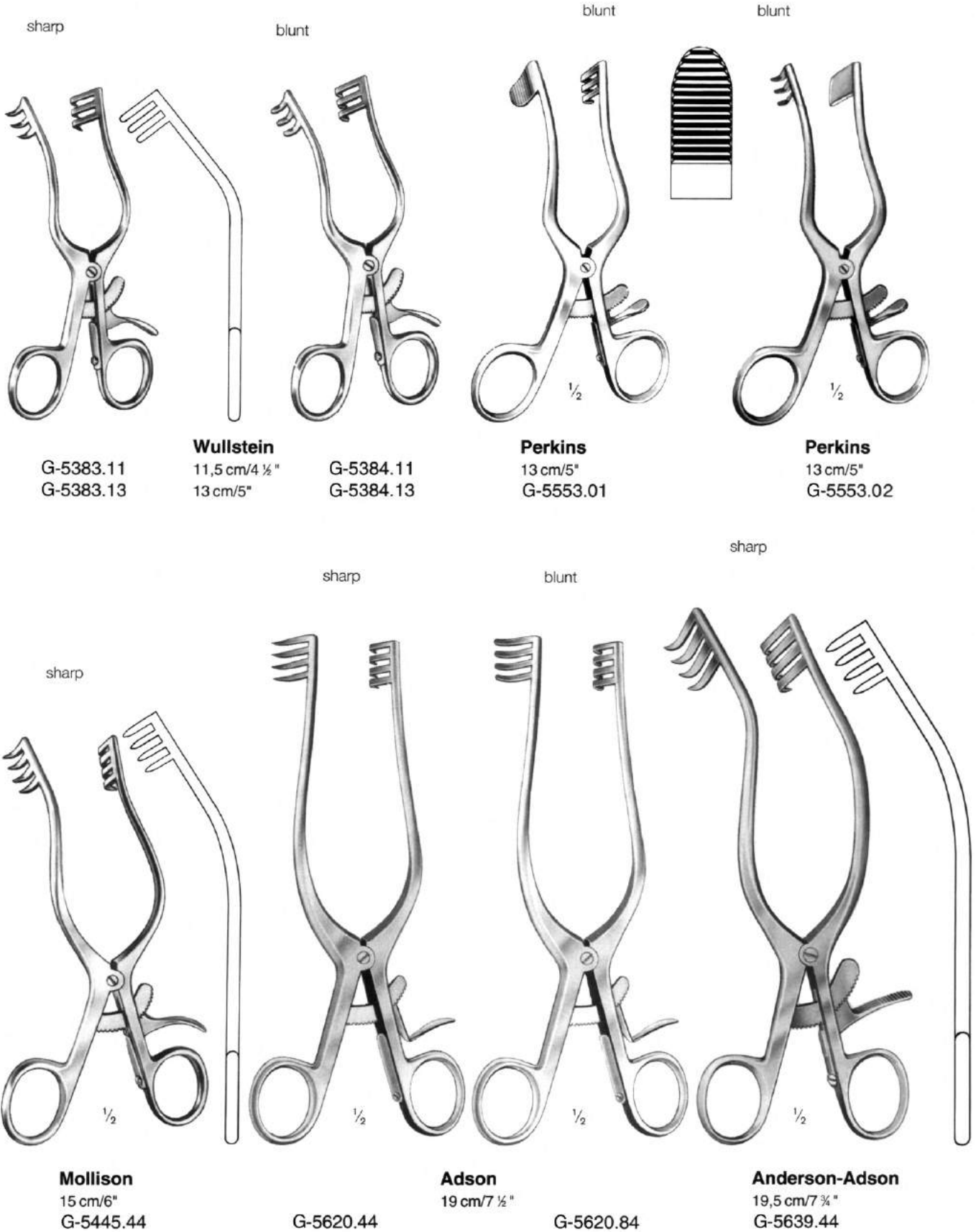

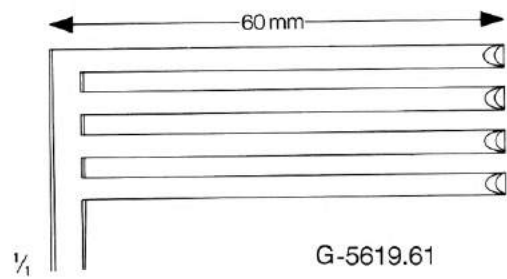
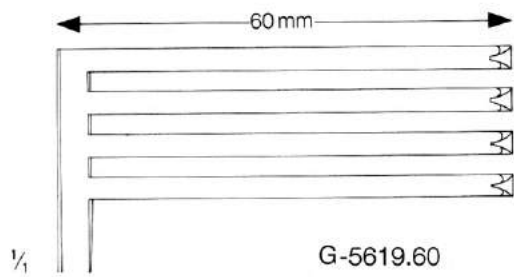
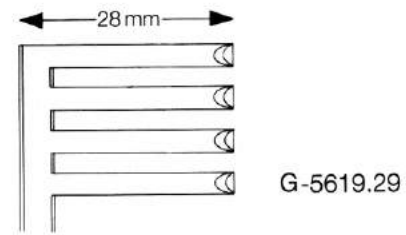
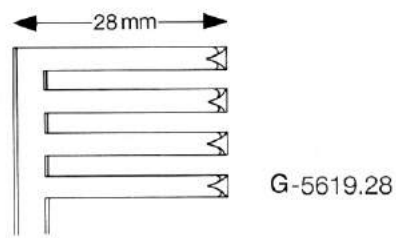
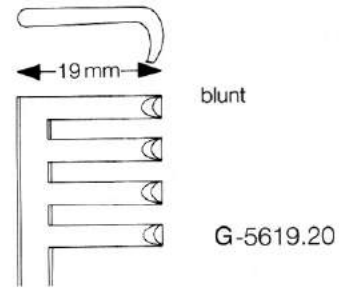
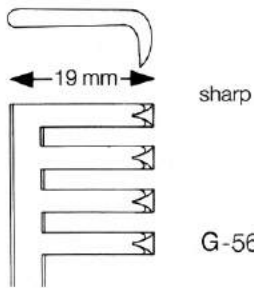

3 x 4 teeth



Henly
 16,5 cm / 6 1/2"

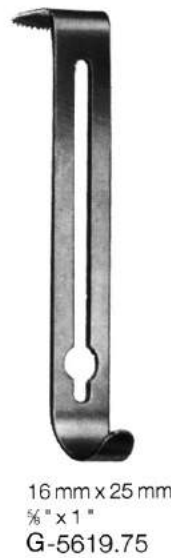
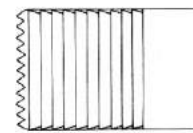
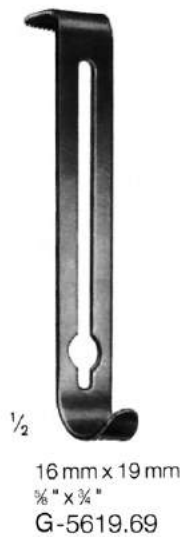
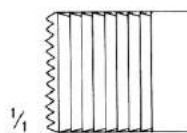

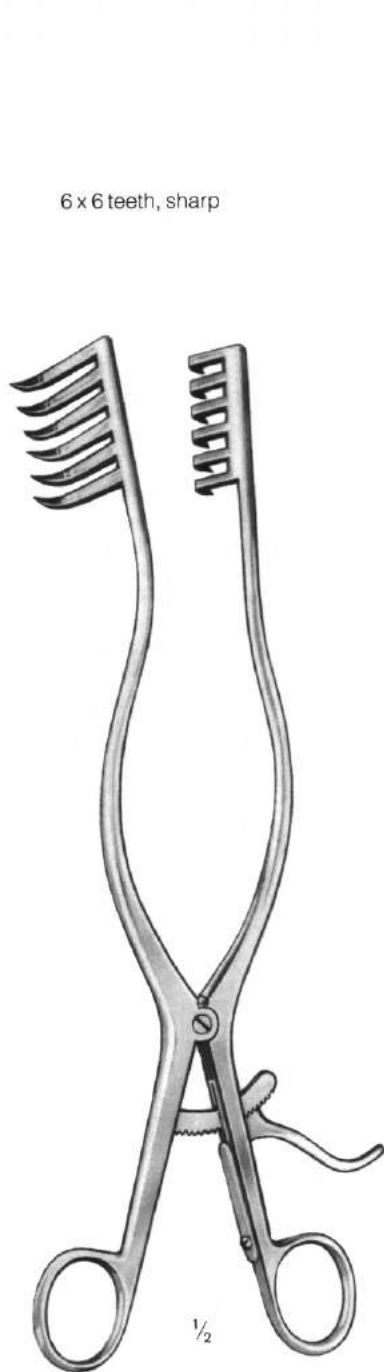

6 x 6 teeth, sharp

Adson
 27 cm/10 3/4"

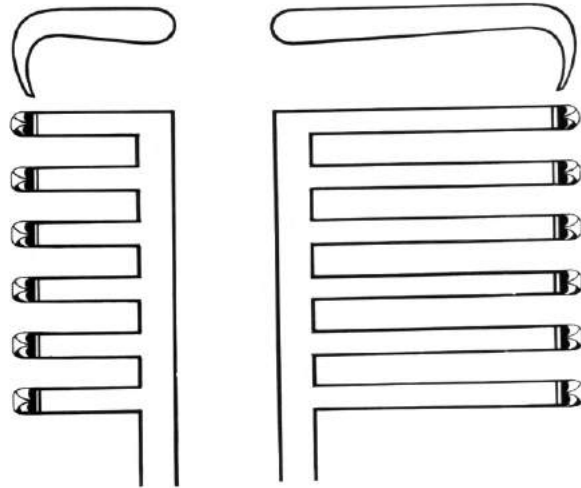

G-5667.01

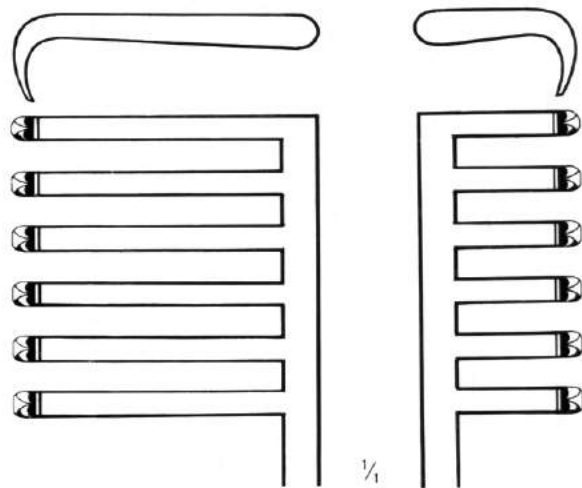

G-5667.02

Self - retaining laminectomy retractors
Ecarteurs autostatiques pour laminectomie
Separadores autostáticos para laminectomía



4 x 4 teeth, sharp

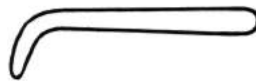

4 x 5 teeth, blunt

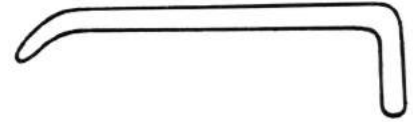

7 x 7 teeth, sharp



Beckmann
 30,5 cm/12"
 G-5681.44

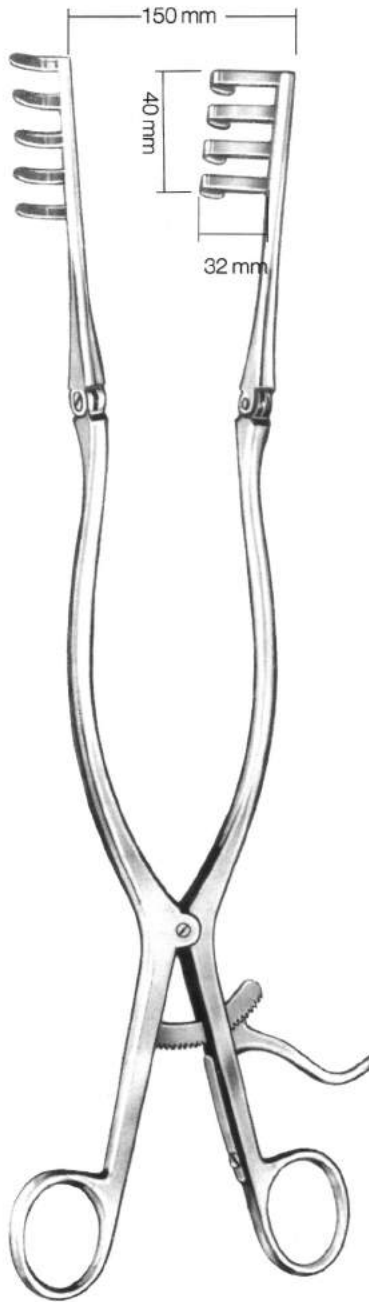

Adson
 33 cm/13"
 G-5693.45



Beckmann-Eaton
 32 cm/12 1/2"
 G-5702.77



Beckman-Adson
 30,5 cm/12"

sharp

blunt

← 25 mm/1" →



← 25 mm/1" →

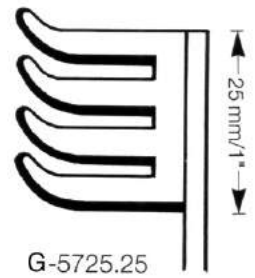

← 32 mm/1 ¼" →



← 32 mm/1 ¼" →



← 40 mm/1 ½" →

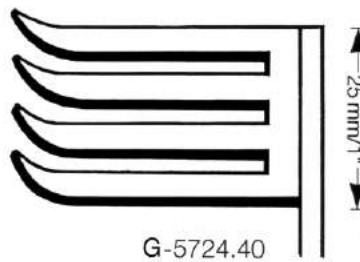

← 40 mm/1 ½" →

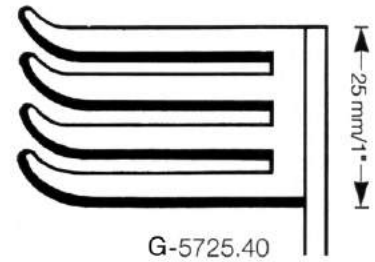

← 45 mm/1 ¾" →

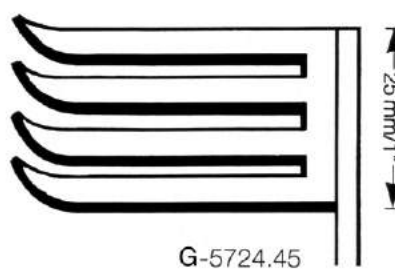

← 45 mm/1 ¾" →

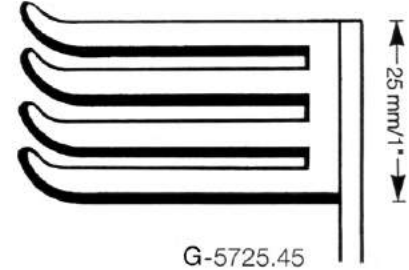



Inge (Baby-Inge)

16 cm/6 ¼"

G-5800.16

Blade opening 38 mm/ 1 ½"

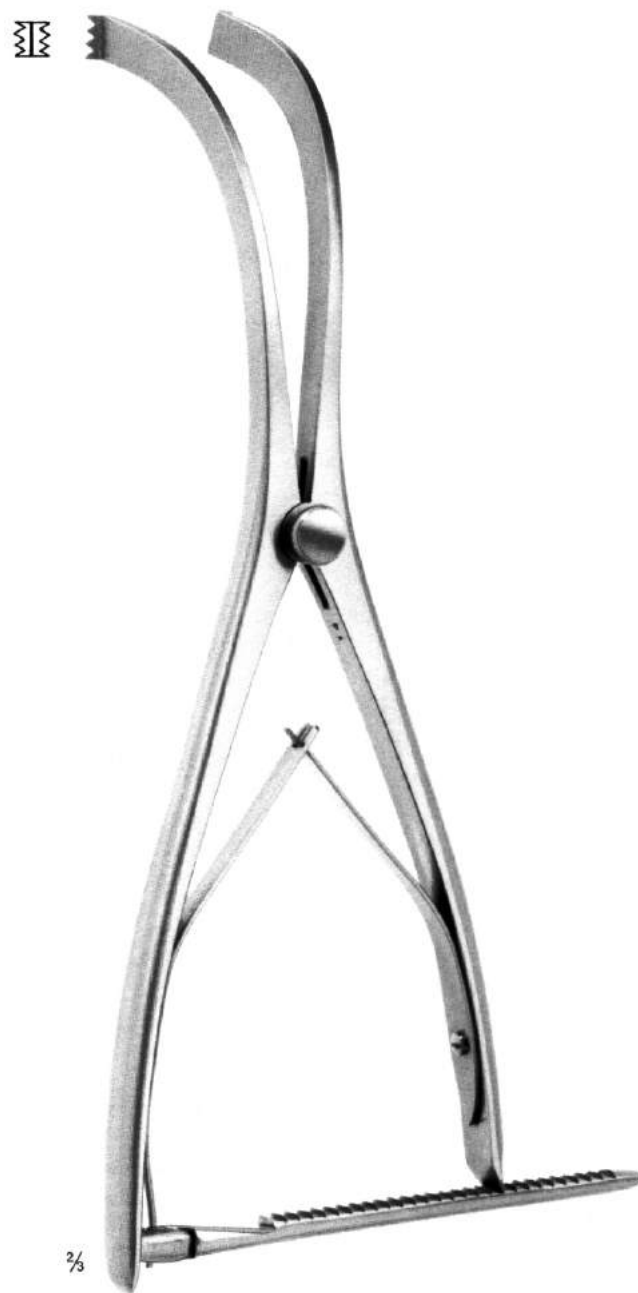

Inge

24 cm/9 ½"

G-5802.24

Blade opening 50 mm/ 2"

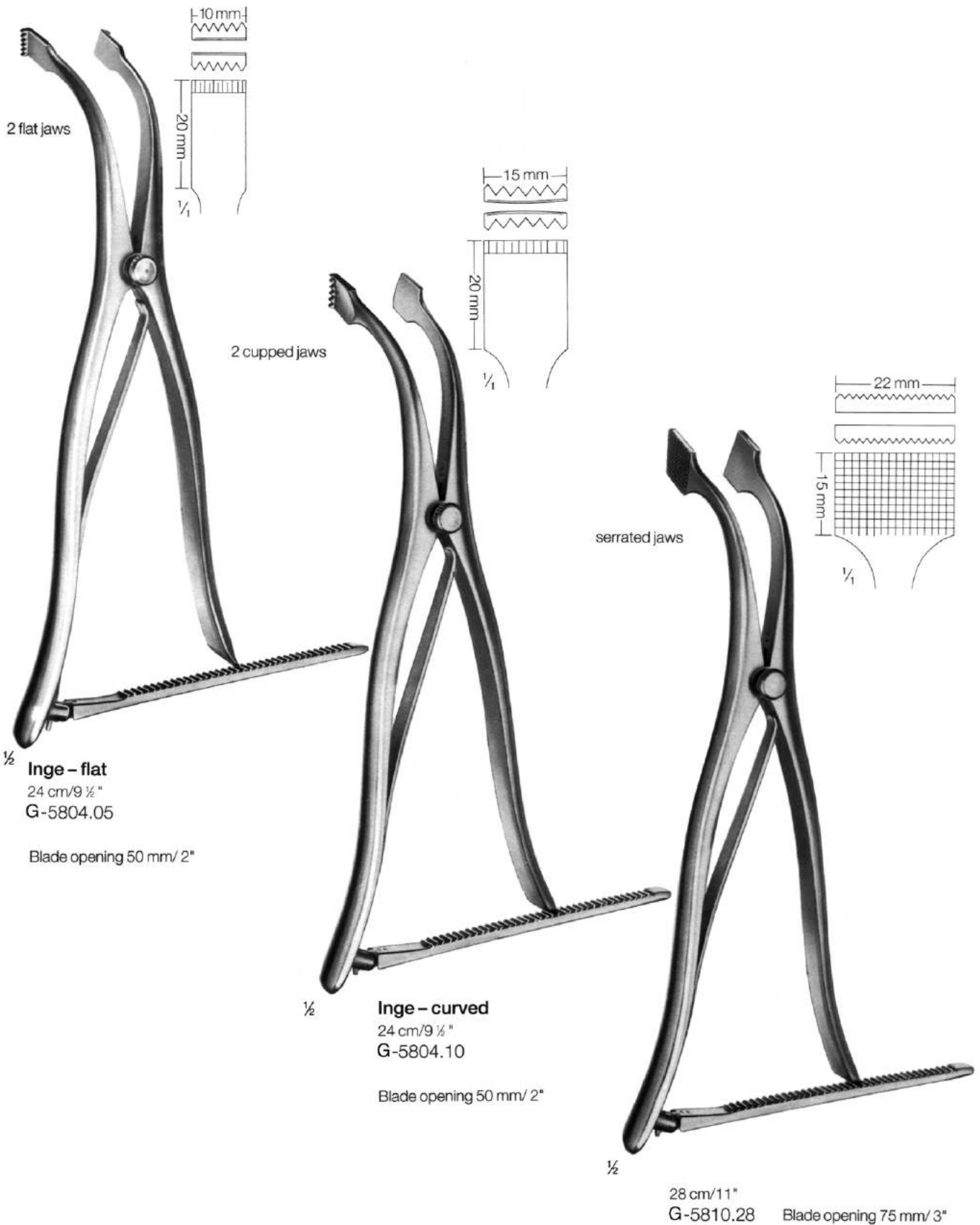

Self - retaining laminectomy retractors
Ecarteurs autostatiques pour laminectomie
Separadores autostáticos para laminectomía

3 x 4 teeth, blunt

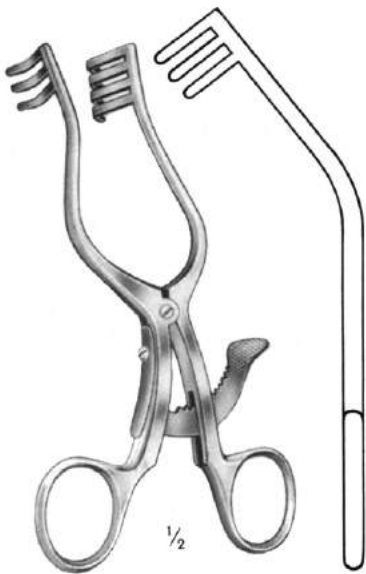

Contour
 14 cm/5 1/2"
 G-5824.64

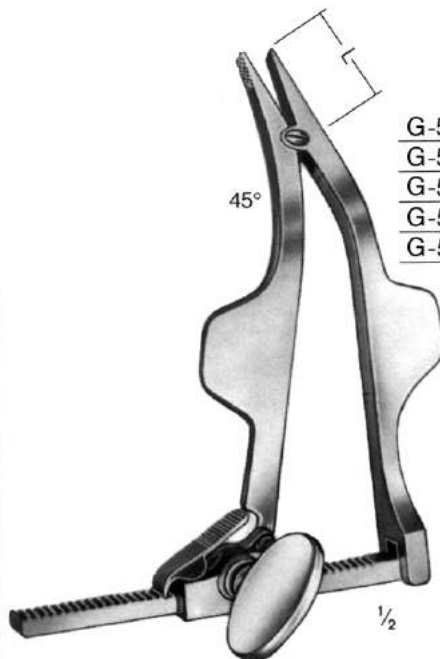

Cloward
 15 cm/6"
 G-5874.30 - G-5875.10

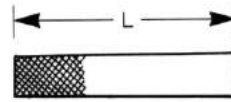

L/mm	
G-5874.30	30
G-5874.50	50
G-5874.70	70
G-5874.90	90
G-5875.10	110



Cloward
 17 cm/6 3/4"
 G-5876.30 - 10-5877.10

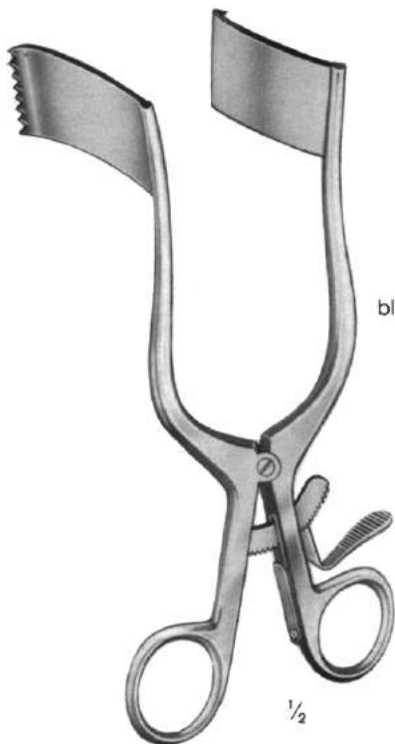

Meyerding
 20 cm/8"
 G-5848.32 32 x 25 mm, 1 1/4" x 1"
 G-5848.54 54 x 25 mm, 2 1/8" x 1"
 G-5848.60 60 x 25 mm, 2 3/8" x 1"
 G-5848.61 60 x 19 mm, 2 3/8" x 3/4"



Markham-Meyerding
 18 cm/7"
 G-5854.18

Hemilaminectomy Retractors

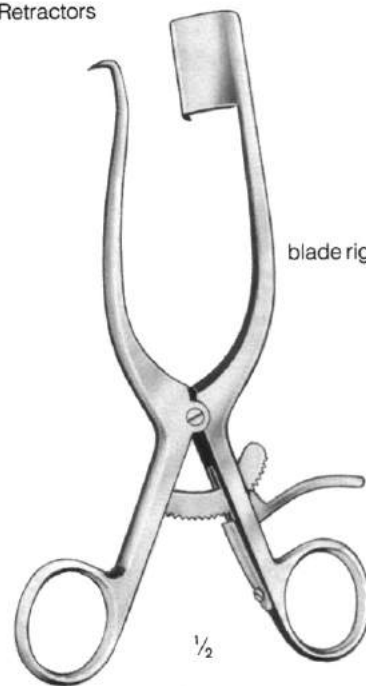

Markham-Meyerding
 18 cm/7"
 G-5855.18

blade opening 125 mm



Cloward-Hoen

23 cm/9"
 G-5911.05

complete with 5 blunt blades

G-5911.00

Retractor without blades

blade opening 114 mm



Cloward

25 cm/10"
 G-5912.05

G-5912.00

Retractor without blades

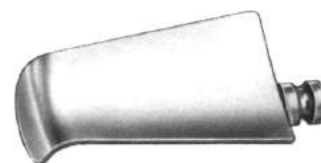

- G-5910.40 = 40 mm
- G-5910.45 = 45 mm
- G-5910.50 = 50 mm
- G-5910.55 = 55 mm
- G-5910.60 = 60 mm

G-5910.95
 set of 5 blunt blades
 # G-5910.40 – 10-5910.60



- G-5912.40 = 40 mm
- G-5912.45 = 45 mm
- G-5912.50 = 50 mm
- G-5912.55 = 55 mm
- G-5912.60 = 60 mm

G-5912.95
 set of 5 toothed blades
 # G-5912.40 – 10-5912.60

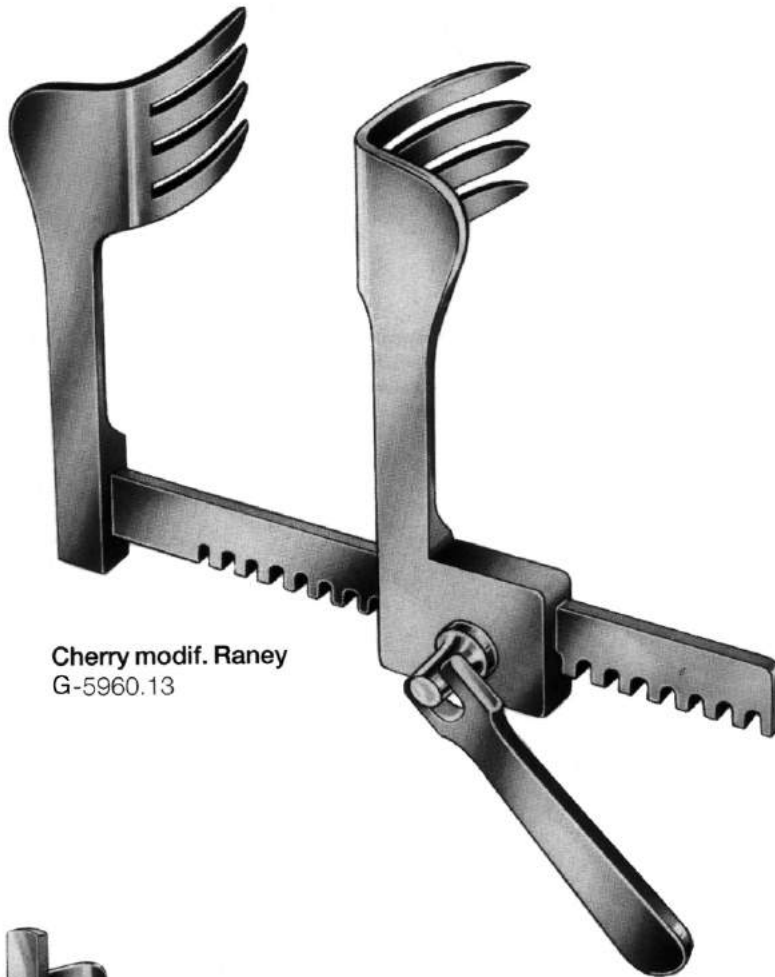

Cherry modif. Raney
 G-5960.13

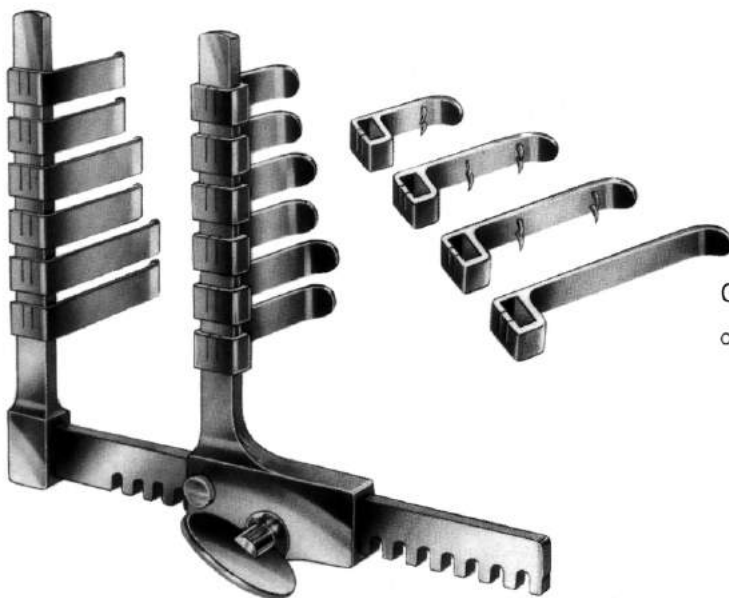
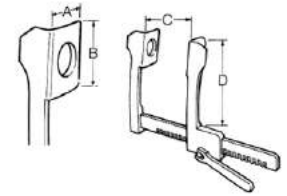

G-5965.12
 complete with 4 ea blades

- # G-5965.40
- # G-5965.50
- # G-5965.65

Blades only

		mm	30	40	50	65	75
Retractor without blades	plain	12	G-5965.30	G-5965.40	G-5965.50	G-5965.65	G-5965.75
		20	G-5966.30	G-5966.40	G-5966.50	G-5966.65	G-5966.75
G-5965.00	with teeth	12		G-5967.40	G-5967.50	G-5967.65	
		20		G-5968.40	G-5968.50	G-5968.65	



Scoville
G-5972.00
Frame only



Scoville-Haverfield
G-5975.00
Frame only

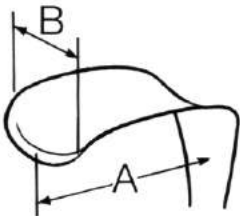

sharp

Scoville

- G-5983.00 50 mm, 2"
- G-5983.05 60 mm, 2 ¼"
- G-5983.10 70 mm, 2 ¾"
- G-5983.20 75 mm, 3"

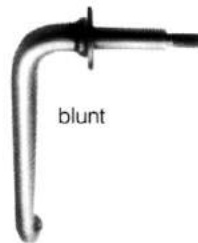

blunt

Scoville

- G-5983.25 50 mm, 2"
- G-5983.27 60 mm, 2 ¼"
- G-5983.30 70 mm, 2 ¾"
- G-5983.35 75 mm, 3"



with stop

Scoville

- G-5986.00 38 mm, 1 ½"
- G-5986.10 50 mm, 2"
- G-5986.20 70 mm, 2 ¾"
- G-5986.30 75 mm, 3"



Scoville

- | | A | B |
|-----------|-------------|-------------|
| G-5984.70 | 41 mm, 1 ½" | 38 mm, 1 ½" |
| G-5984.80 | 67 mm, 2 ¾" | 44 mm, 1 ¾" |



Taylor

- | | A | B |
|-----------|-------------|-------------|
| G-5987.90 | 25 mm, 1" | 41 mm, 1 ½" |
| G-5988.00 | 44 mm, 1 ¾" | 38 mm, 1 ½" |
| G-5988.10 | 50 mm, 2" | 41 mm, 1 ½" |



Taylor

- | | A | B |
|-----------|-------------|-------------|
| G-5984.40 | 48 mm, 1 ¾" | 50 mm, 2" |
| G-5984.45 | 64 mm, 2 ½" | 50 mm, 2" |
| G-5984.50 | 64 mm, 2 ½" | 64 mm, 2 ½" |
| G-5984.60 | 80 mm, 3 ¼" | 57 mm, 2 ¼" |

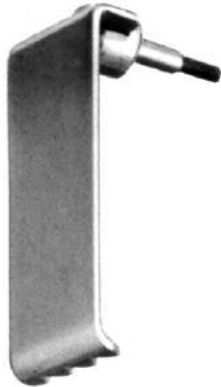

Scoville	A	B
G-5983.60	50 mm, 2"	25 mm, 1"
G-5983.70	50 mm, 2"	50 mm, 2"
G-5983.80	57 mm, 2 ¼"	25 mm, 1"
G-5983.90	57 mm, 2 ¼"	38 mm, 1 ½"
G-5984.00	64 mm, 2 ½"	25 mm, 1"
G-5984.06	64 mm, 2 ½"	29 mm, 1 ⅙"
G-5984.10	64 mm, 2 ½"	50 mm, 2"
G-5984.20	67 mm, 2 ¾"	28 mm, 1 ⅙"
G-5984.22	67 mm, 2 ¾"	30 mm, 1 ⅜"
G-5984.24	75 mm, 3"	25 mm, 1"
G-5984.26	75 mm, 3"	50 mm, 2"
G-5984.30	88 mm, 3 ½"	25 mm, 1"
G-5984.32	100 mm, 4"	50 mm, 2"

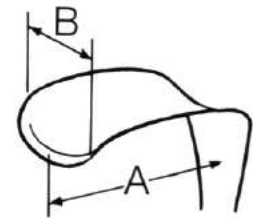

Taylor	A	B
G-5987.00	75 mm, 3"	32 mm, 1 ¼"
G-5987.50	100 mm, 2 ¾"	42 mm, 1 ½"



Meyerding	A	B
G-5985.00	50 mm, 2"	25 mm, 1"
G-5985.20	70 mm, 2 ¾"	25 mm, 1"
G-5985.40	83 mm, 3 ¼"	25 mm, 1"



Hibbs	A	B
G-5989.00	50 mm, 2"	19 mm, ¾"
G-5989.05	50 mm, 2"	25 mm, 1"
G-5989.10	50 mm, 2"	50 mm, 2"
G-5989.15	64 mm, 2 ½"	25 mm, 1"
G-5989.20	64 mm, 2 ½"	38 mm, 1 ½"
G-5989.25	75 mm, 3"	25 mm, 1"
G-5989.30	75 mm, 3"	38 mm, 1 ½"
G-5989.35	75 mm, 3"	50 mm, 2"
G-5989.40	75 mm, 3"	64 mm, 2 ½"
G-5989.45	88 mm, 3 ½"	25 mm, 1"
G-5989.50	88 mm, 3 ½"	38 mm, 1 ½"
G-5989.55	100 mm, 4"	25 mm, 1"
G-5989.60	100 mm, 4"	50 mm, 2"



G-5921.38
Hook 38 mm



G-5921.58
Hook 58 mm



	A	B
G-5922.32	32 x 22 mm	
G-5922.37	37 x 22 mm	
G-5922.43	43 x 22 mm	
G-5922.47	47 x 22 mm	
G-5922.52	52 x 22 mm	
G-5922.57	57 x 22 mm	
G-5922.62	62 x 22 mm	
G-5922.67	67 x 22 mm	

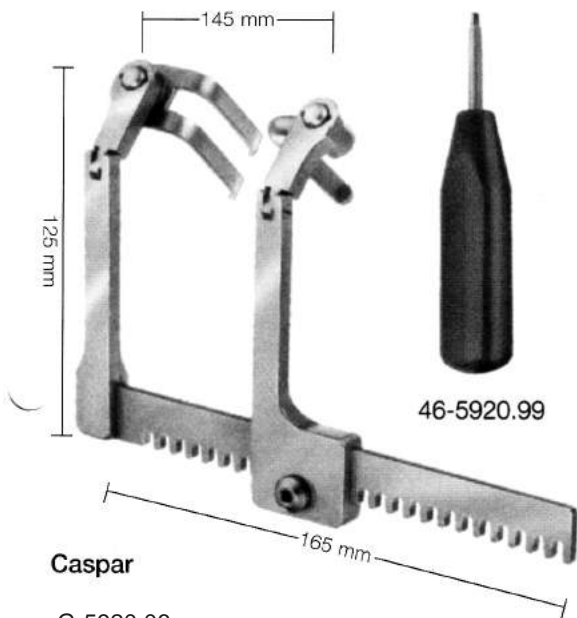

Caspar

G-5920.06

Retractor complete, consisting of:

G-5920.00 Retractor only

G-5920.99

G-5921.38

G-5922.37

G-5922.43

G-5922.47

G-5922.52

G-5922.57

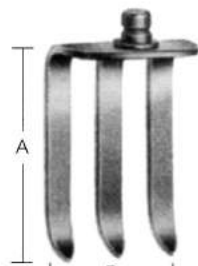

	A	B
G-5923.32	32 x 37 mm	
G-5923.37	37 x 37 mm	
G-5923.43	43 x 37 mm	
G-5923.47	47 x 37 mm	
G-5923.52	52 x 37 mm	
G-5923.57	57 x 37 mm	
G-5923.62	62 x 37 mm	
G-5923.67	67 x 37 mm	



	A	B
G-5924.32	32 x 52 mm	
G-5924.37	37 x 52 mm	
G-5924.43	43 x 52 mm	
G-5924.47	47 x 52 mm	
G-5924.52	52 x 52 mm	
G-5924.57	57 x 52 mm	
G-5924.62	62 x 52 mm	
G-5924.67	67 x 52 mm	

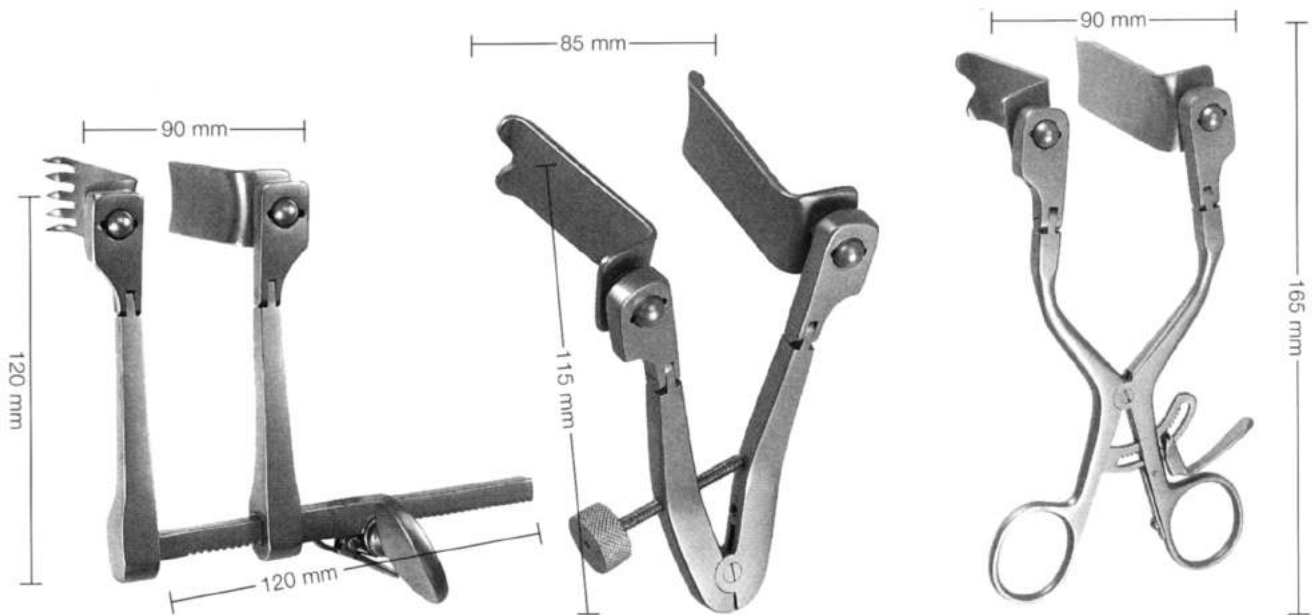

Caspar

G-5931.10
 Retractor, adjustable, consisting of:
 G-5931.00 Retractor only
 G-5932.40 – G-5932.60 medial blades
 G-5933.40 – G-5933.60 lateral blades

Caspar

G-5952.05
 Retractor (speculum pattern),
 G-5952.00 Retractor only
 G-5934.45 – G-5934.65

Caspar

G-5953.05
 Counter Retractor,
 G-5953.00 Retractor only

LEYLA

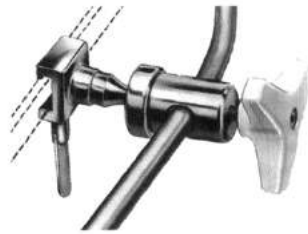

Ball- and Socket Joint,
G-5960.44



G-5960.22
Holding Rod,
head



Coupling Head,
to take 1-5 flexible arms
G-5960.33



G-5960.11
Flexible arm only,
for attaching coupling heads

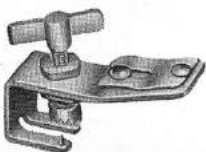

G-5960.01
Fixation Base, for skull mounting,
holding 1 flexible arm



G-5960.02
Fixation Base, for skull mounting,
holding 2 flexible arms



G-5960.03
Fixation Base, for mounting to bars up to
16 mm diam., holding 1 flexible arm

Abdominal and intestinal spatulas
Ecarteurs intra-abdominaux-ecarteurs à intestin
Espátulas abdominales y espátulas intestinales

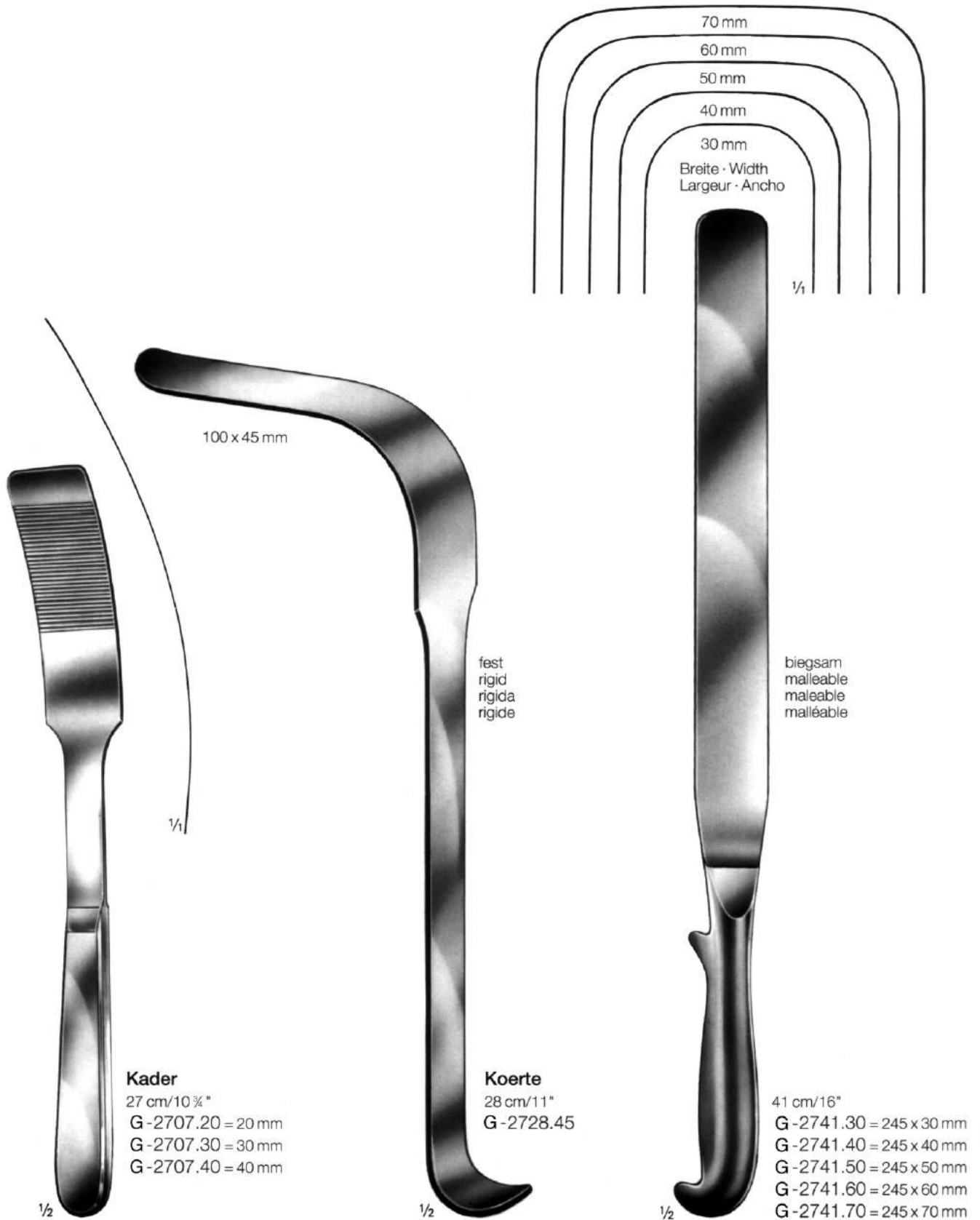

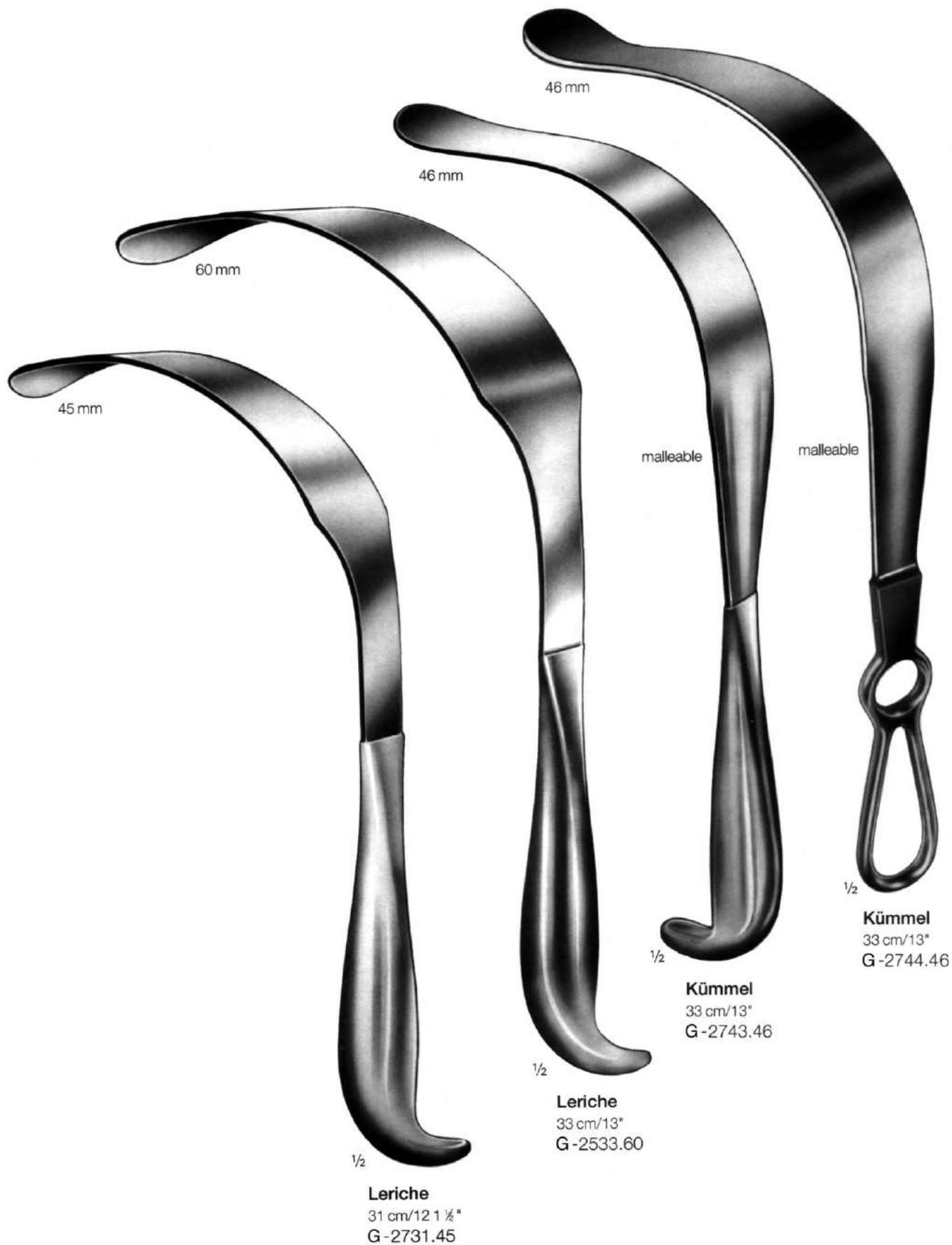

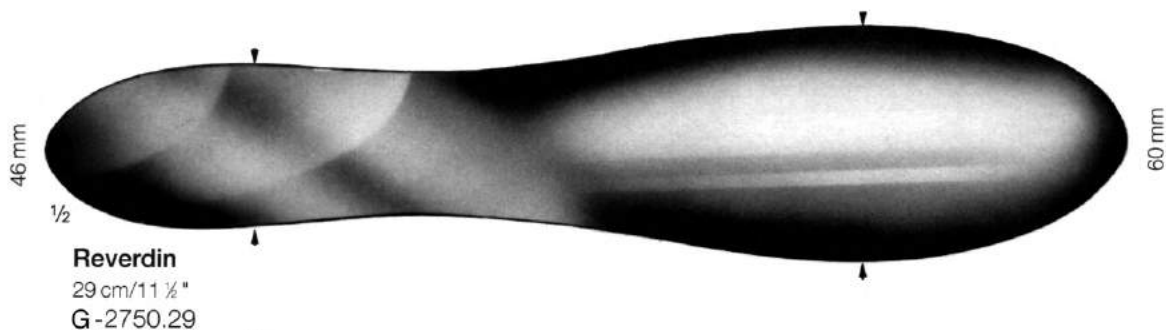

Reverdin
29 cm/11 1/4"
G-2750.29

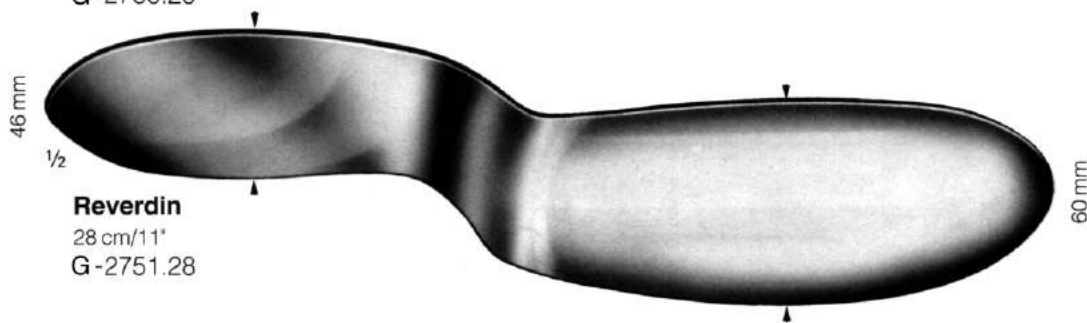

Reverdin
28 cm/11"
G-2751.28



G-2763.20 = 330 x 20 mm
G-2763.25 = 330 x 25 mm
G-2763.30 = 330 x 30 mm
G-2763.40 = 330 x 40 mm
G-2763.50 = 330 x 50 mm
33 cm/13"
malleable



Haberer
G-2766.28 28 cm/11" 25/30 mm
G-2766.30 30 cm/12" 37/45 mm
G-2766.31 30 cm/12" 40/50 mm
malleable



Tuffier
20 cm/8" malleable
G-2768.20



G-2780.06 = 200 x 6 mm
G-2780.08 = 200 x 8 mm
G-2780.10 = 200 x 10 mm
G-2780.12 = 200 x 12 mm
G-2780.17 = 200 x 17 mm
G-2780.20 = 200 x 20 mm
G-2780.25 = 200 x 25 mm
G-2782.25 = 250 x 25 mm
malleable







$\frac{1}{2}$
Mikulicz
 26 cm/10 $\frac{1}{4}$ "
 G - 2360.85

$\frac{1}{2}$
Mikulicz
 26 cm/10 $\frac{1}{4}$ "
 G - 2361.20 = 120 x 50 mm
 G - 2361.55 = 155 x 50 mm



Mikulicz
 26 cm/10 1/4"
 G-2366.90

Kelly
 27 cm/10 1/2"
 G-2371.63 = 160 x 38 mm
 G-2371.65 = 160 x 57 mm
 G-2371.93 = 190 x 38 mm
 G-2371.95 = 190 x 57 mm

Abdominal retractors

Ecarteurs à paroi abdominale

Separadores abdominales

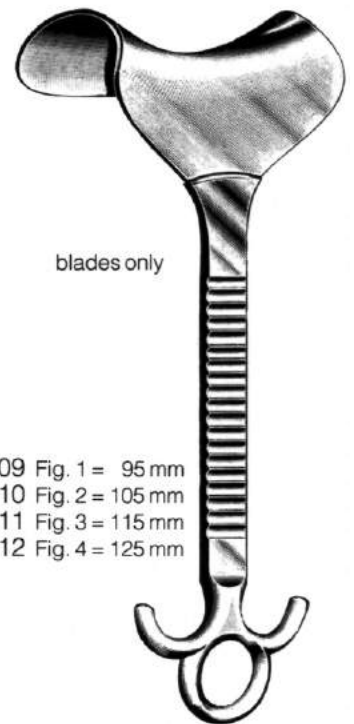
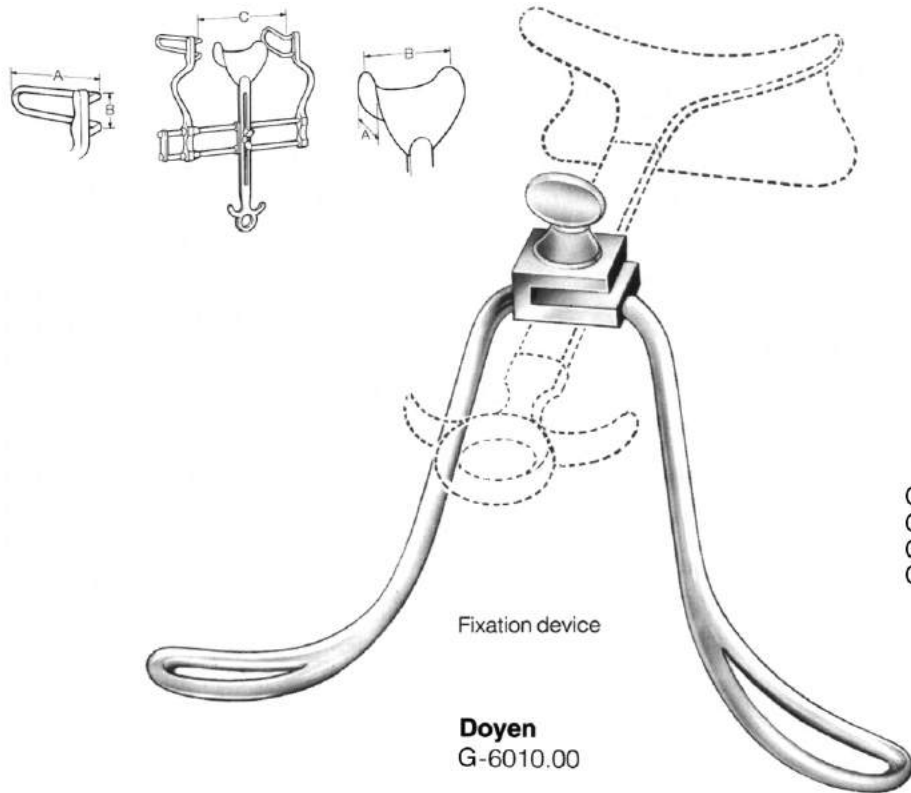

G-6010.09 Fig. 1 = 95 mm
G-6010.10 Fig. 2 = 105 mm
G-6010.11 Fig. 3 = 115 mm
G-6010.12 Fig. 4 = 125 mm

Doyen



Mayo-Adams
(Appendectomie)
17 cm/6 3/4"
G-6020.00

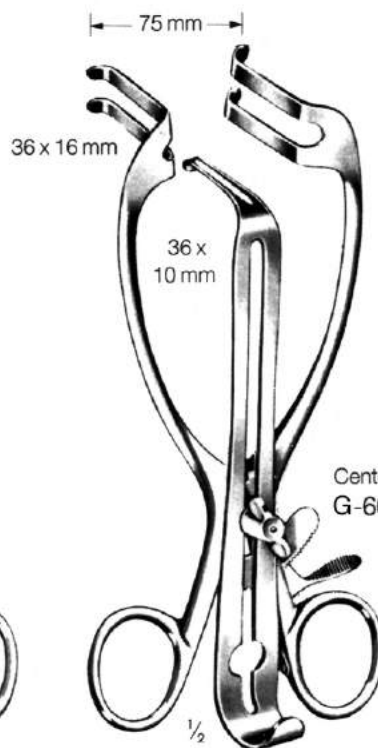

Mayo-Adams
(Appendectomie)
17 cm/6 3/4"
G-6020.01

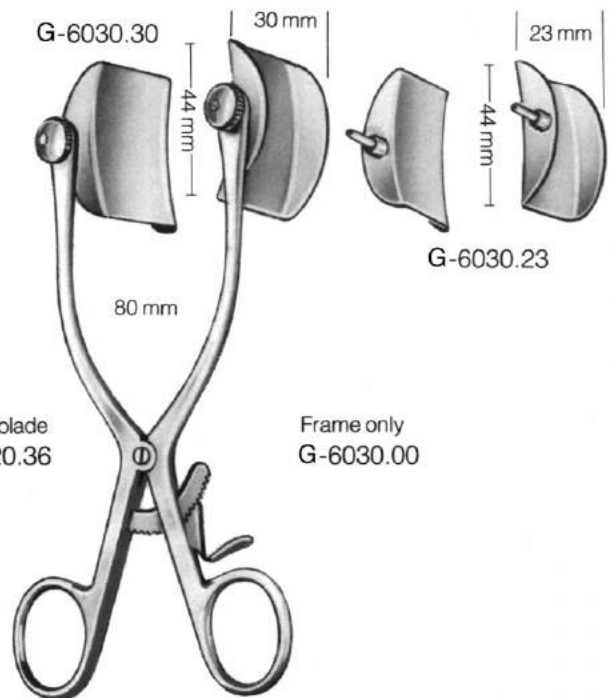

Baby-Collin
G-6030.04

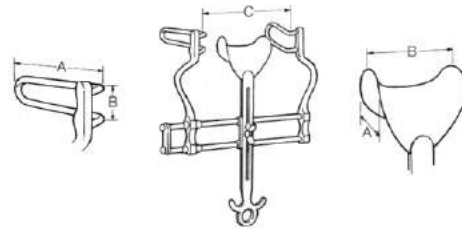

Frame only
 G-6040.00

Collin
 G-6040.10

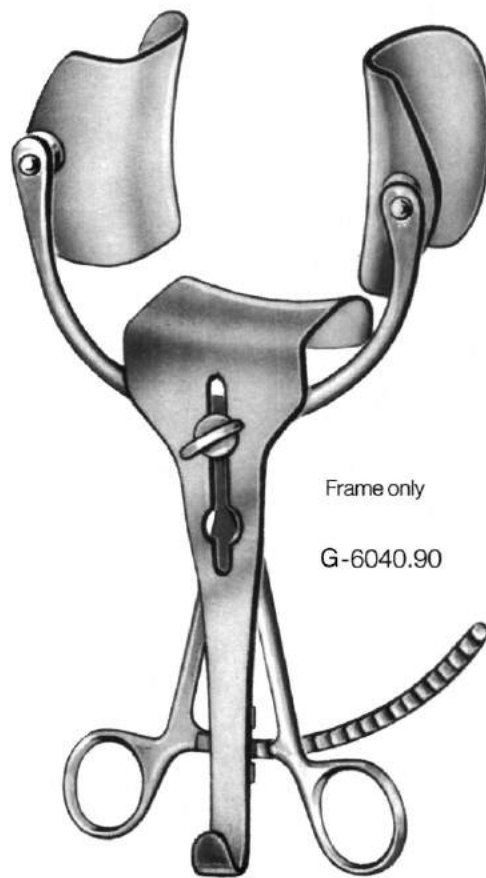

Frame only
 G-6040.90

Collin
 G-6041.10
 G-6042.10
 G-6043.10

complete	lateral blades		center blades			blade opening	
Ref.	Ref.	A	B	Ref.	A	B	C
G-6040.10	10-6150.62	32 mm/1 ¼"	62 mm/2 ½"	—	—	—	100 mm/4"
G-6041.10	G-6150.62	32 mm/1 ¼"	62 mm/2 ½"	G-6153.55	55 mm/2 ½"	55 mm/2 ½"	100 mm/4"
G-6042.10	G-6150.80	38 mm/1 ½"	80 mm/3 ⅞"	G-6153.65	55 mm/2 ½"	65 mm/2 ⅝"	100 mm/4"
G-6043.10	G-6150.99	38 mm/1 ½"	100 mm/4"	G-6153.75	55 mm/2 ½"	75 mm/3"	100 mm/4"

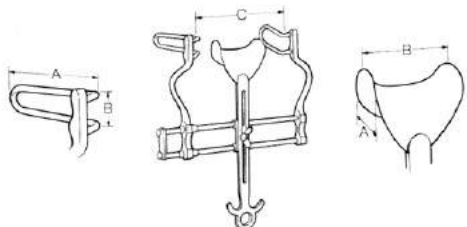

Ball Snap Closure

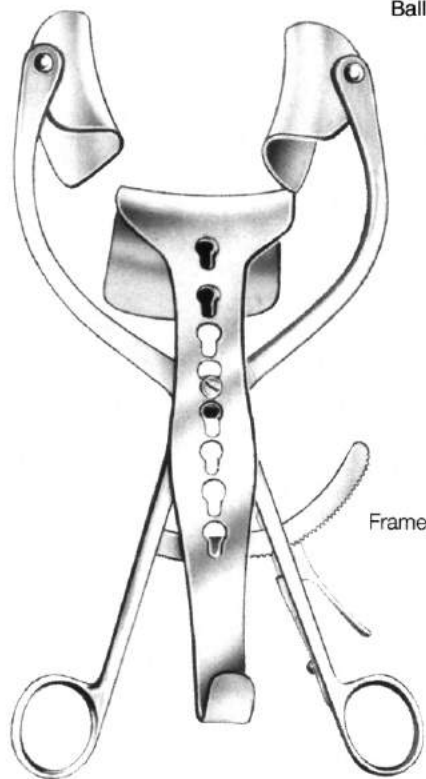

Frame only

Collin-Locktite
 G-6050.10
 G-6051.10

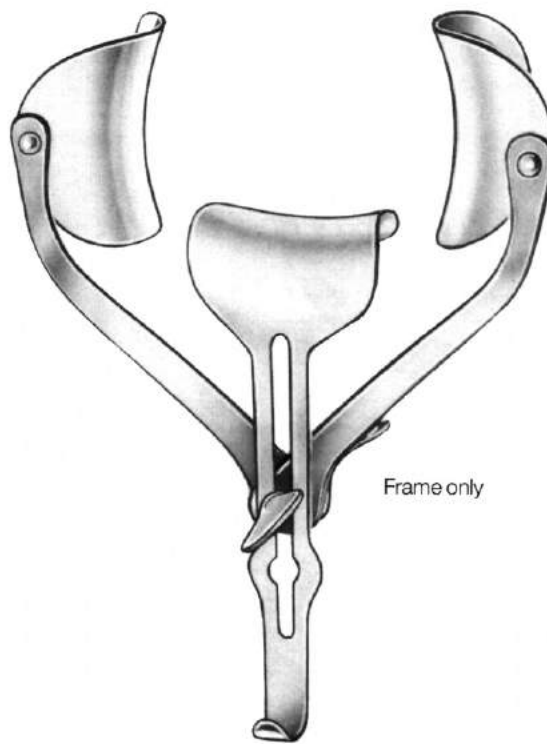

Frame only

Ricard
 G-6128.10
 G-6130.10

complete	lateral blades			center blades			blade opening
Ref.	Ref.	A	B	Ref.	A	B	C
G-6050.10	G-6151.58	50 mm/2"	58 mm/2 1/4"	G-6155.67	62 mm/2 1/2"	67 mm/2 3/4"	165 mm/6 1/2"
G-6051.10	G-6151.80	62 mm/2 1/2"	80 mm/3 1/8"	G-6155.70	62 mm/2 1/2"	70 mm/2 3/4"	165 mm/6 1/2"
G-6128.10	G-6152.72	72 mm/2 7/8"	85 mm/3 3/8"	G-6155.80	80 mm/3 1/8"	90 mm/3 1/2"	280 mm/11"
G-6130.10	G-6152.60	60 mm/2 3/8"	80 mm/3 1/8"	G-6155.55	55 mm/2 1/8"	70 mm/2 3/4"	305 mm/12"

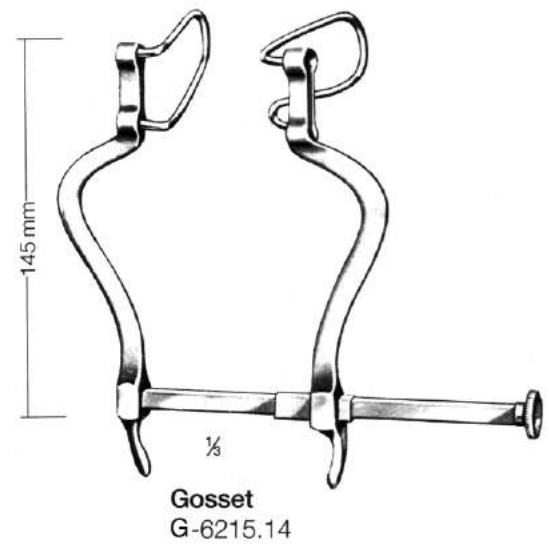
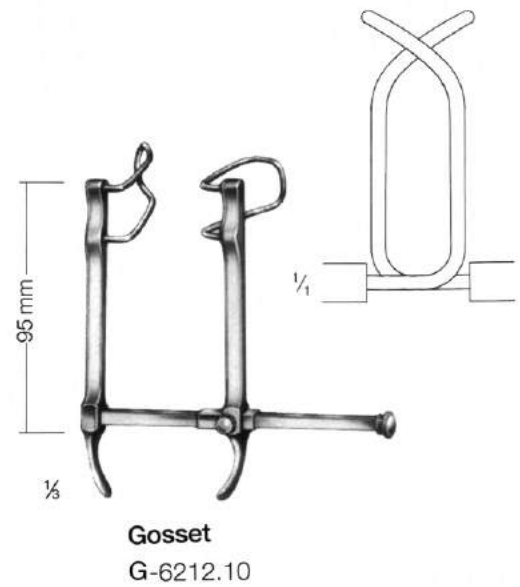
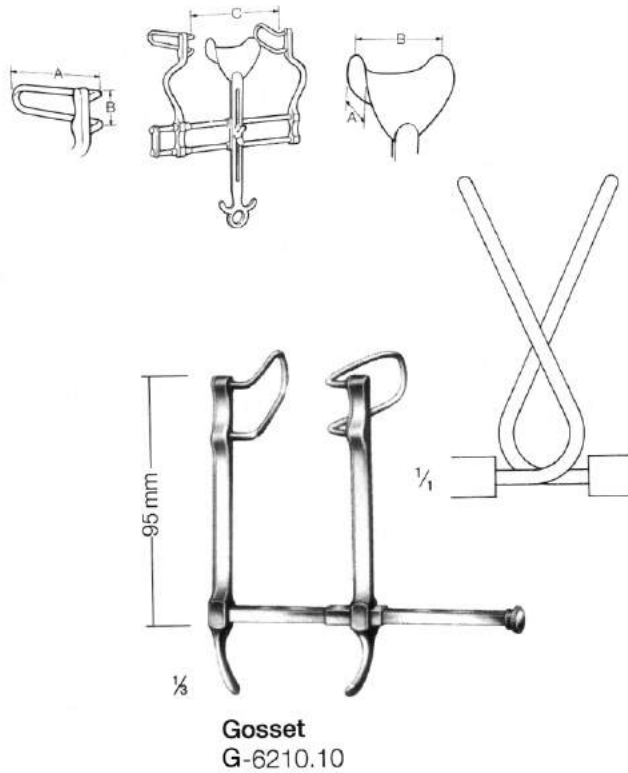

complete	lateral blades			center blades			blade opening
Ref.	Ref.	A	B	Ref.	A	B	C
G-6210.10	-	40 mm	30 mm	-	-	-	100 mm
G-6212.10	-	40 mm	30 mm	-	-	-	100 mm
G-6214.16	-	63 mm	35 mm	G-6214.60	60 mm	57 mm	160 mm
G-6215.14	-	63 mm	35 mm	-	-	-	140 mm

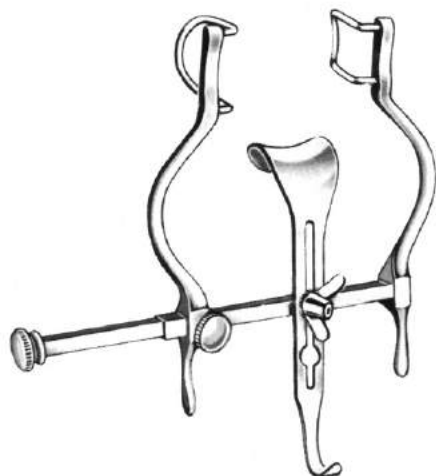
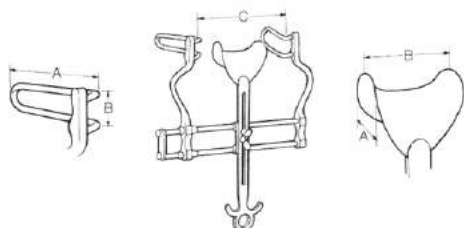

Balfour-Baby
G-6230.09

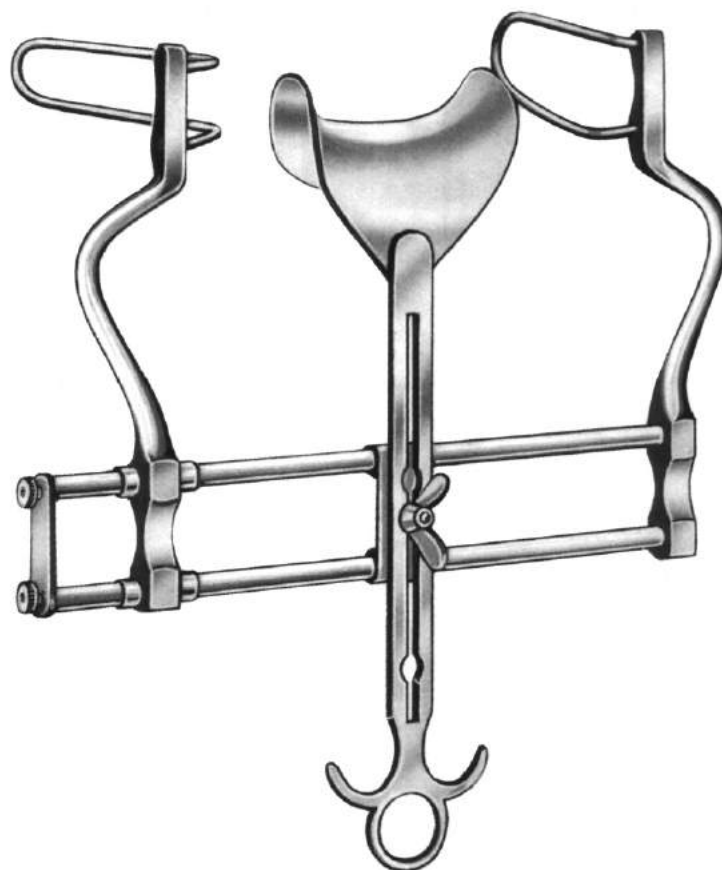

Balfour
G-6240.18
G-6246.25

complete	lateral blades			center blades			blade opening
Ref.	Ref.	A	B	Ref.	A	B	C
G-6230.09	—	27 mm	25 mm	G-6230.20	24 mm	20 mm	90 mm
G-6240.18	—	70 mm	35 mm	G-6252.45	45 mm	80 mm	180 mm
G-6246.25	—	100 mm	35 mm	G-6252.70	70 mm	85 mm	250 mm

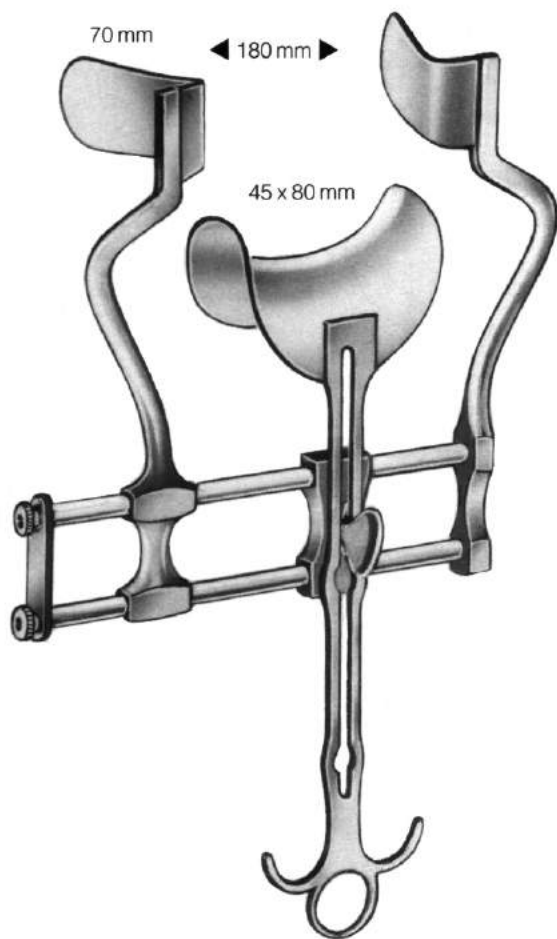
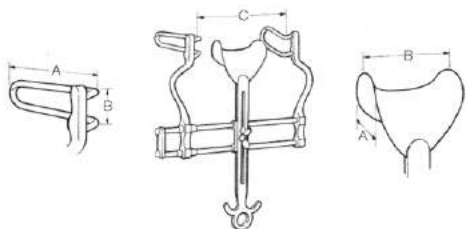

Balfour
G-6248.18

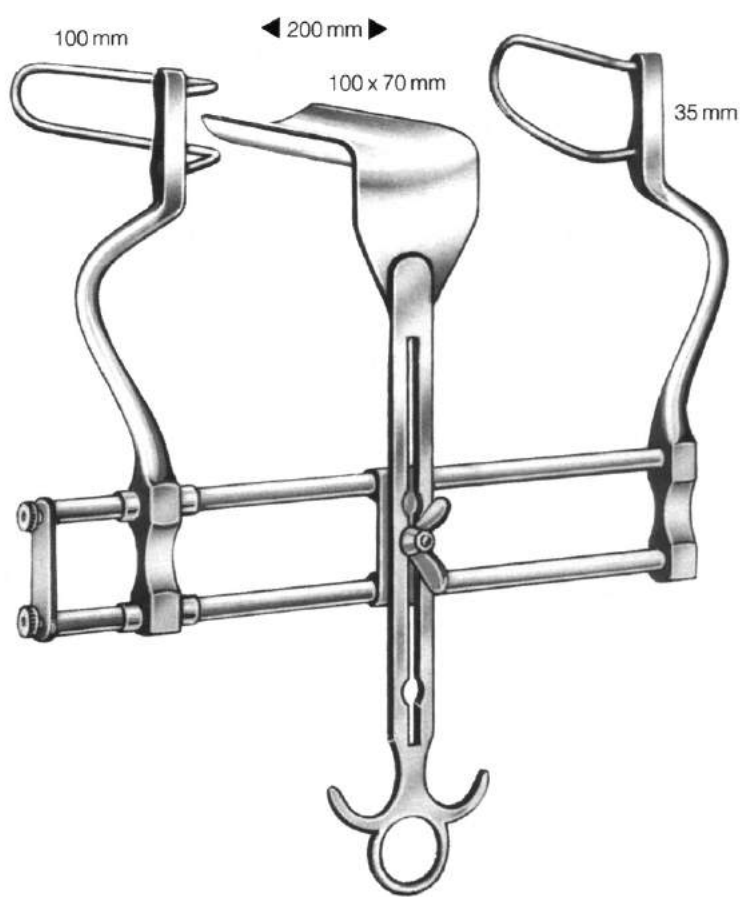

Balfour
G-6244.20

complete	lateral blades			center blades			blade opening
Ref.	Ref.	A	B	Ref.	A	B	C
G-6244.20	—	100 mm	35 mm	G-6256.99	100 mm	70 mm	200 mm
G-6248.18	—	70 mm	35 mm	G-6252.45	45 mm	80 mm	180 mm

Abdominal retractors
Ecarteurs à paroi abdominale
Separadores abdominales



110 x 70 mm
 G-6305.70
 80 x 45 mm
 G-6305.45

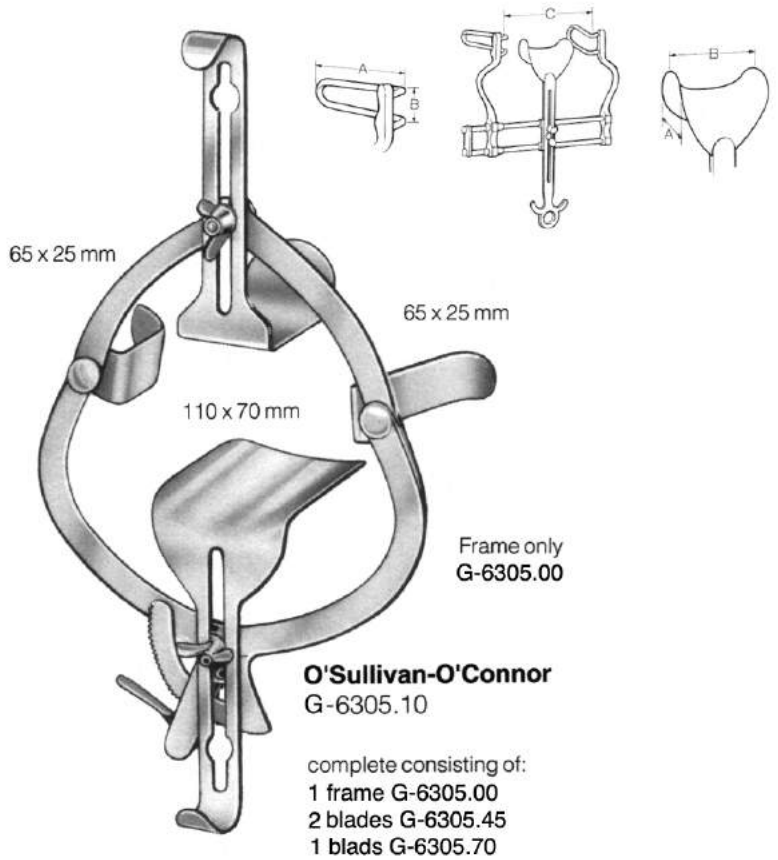

Frame only
 G-6305.00

O'Sullivan-O'Connor
 G-6305.10

complete consisting of:
 1 frame G-6305.00
 2 blades G-6305.45
 1 blades G-6305.70

Frame only
 240 x 240 mm
 G-6320.00

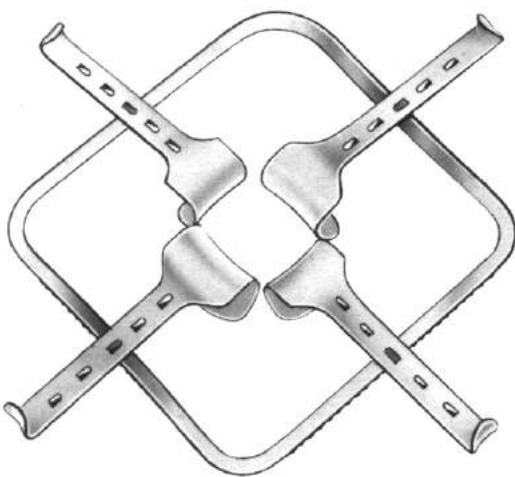

Kirschner
 G-6320.10

complete consisting of:
 rigid frame, G-6320.00
 2 blades, 50 x 65 mm G-6320.50
 2 blades, 40 x 55 mm G-6320.40



40 x 55 mm
 G-6320.40



50 x 65 mm
 G-6320.50



60 x 85 mm
 G-6321.60

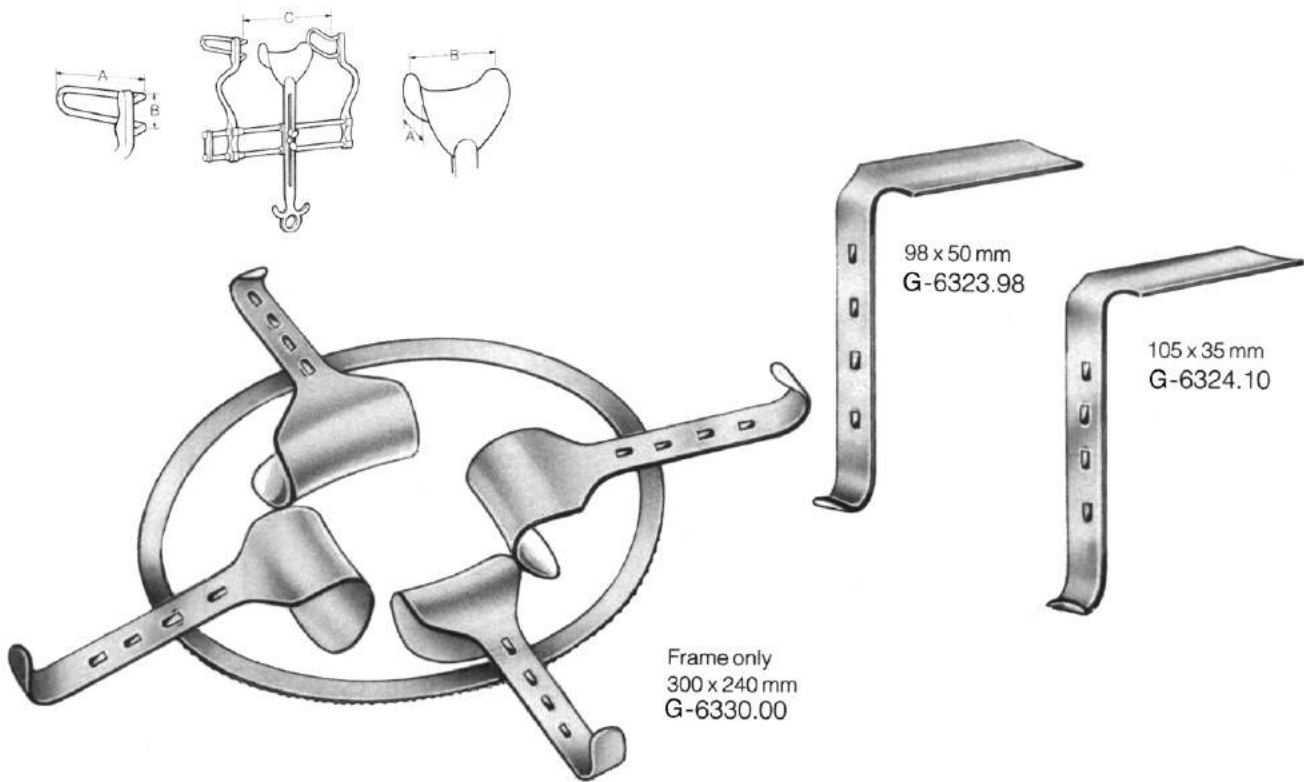

Kirschner, oval

G-6330.10

complete consisting of:

- 1 frame, 300 x 240 mm: G-6330.00
- 3 blades, 50 x 65 mm: G-6320.50
- 1 blade, 80 x 90 mm: G-6321.90
- 1 blade, 98 x 50 mm: G-6323.98
- 1 blade, 105 x 35 mm: G-6324.10

Blades for Kirschner-Abdominal Retractors



A x B 40 x 55 mm
G-6320.40

50 x 65 mm
G-6320.50

60 x 85 mm
G-6321.60

78 x 65 mm
G-6321.78

80 x 90 mm
G-6321.90

98 x 50 mm
G-6323.98

105 x 35 mm
G-6324.10

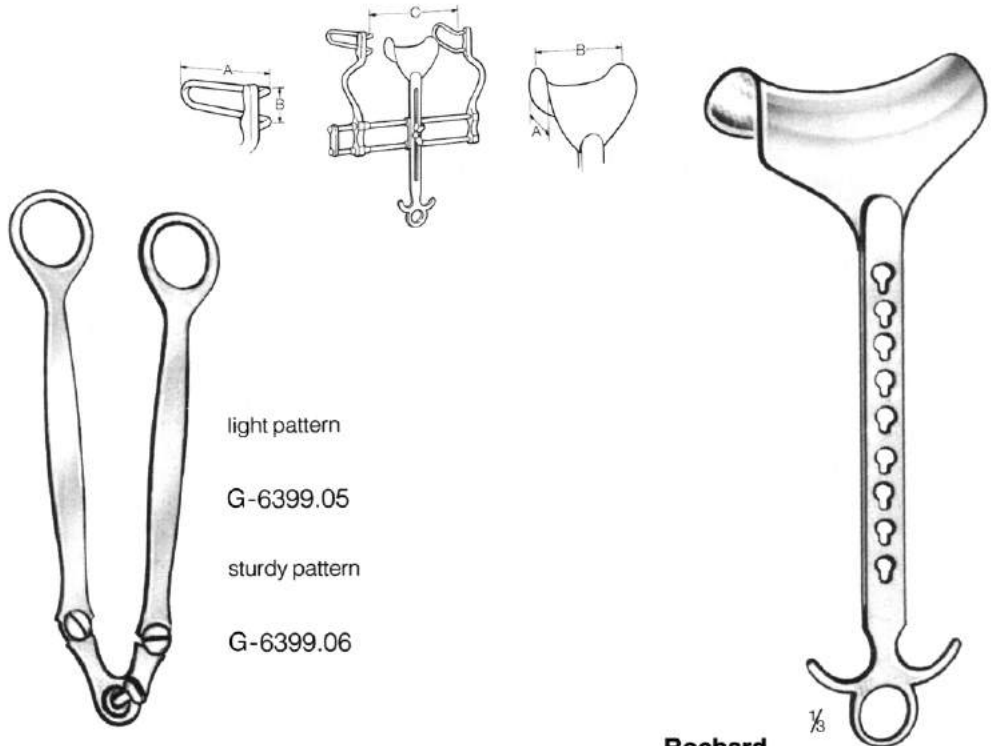

Rochard
 19 cm/7 3/4"
 Fixation device

light pattern
 G-6399.05
 sturdy pattern
 G-6399.06

Rochard
 27 cm/10 1/2"
 G-6399.10 50 x 95 mm, 2" x 3 3/4"
 G-6399.15 50 x 105 mm, 2" x 4 1/8"
 G-6399.20 60 x 120 mm, 2 3/8" x 4 3/4"
 G-6399.25 60 x 135 mm, 2 3/8" x 5 1/4"
 G-6399.30 60 x 155 mm, 2 3/8" x 6 1/8"

Mounting Frames for Operating Tables

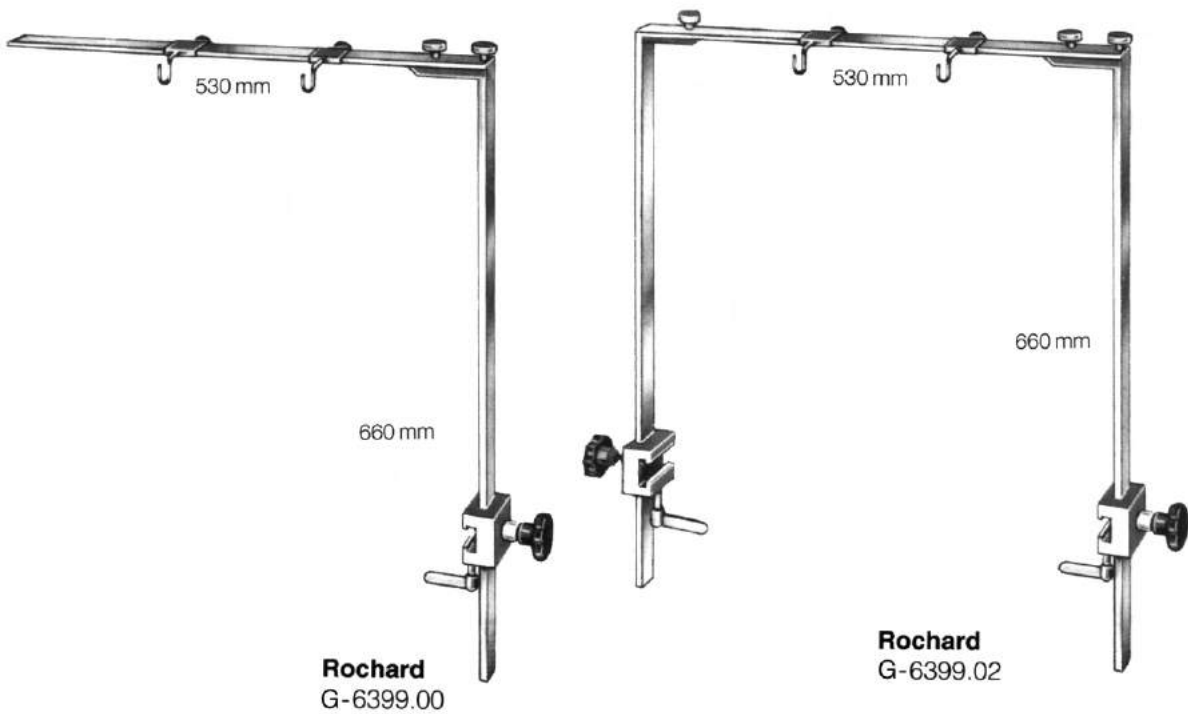

Rochard
 G-6399.00

Rochard
 G-6399.02

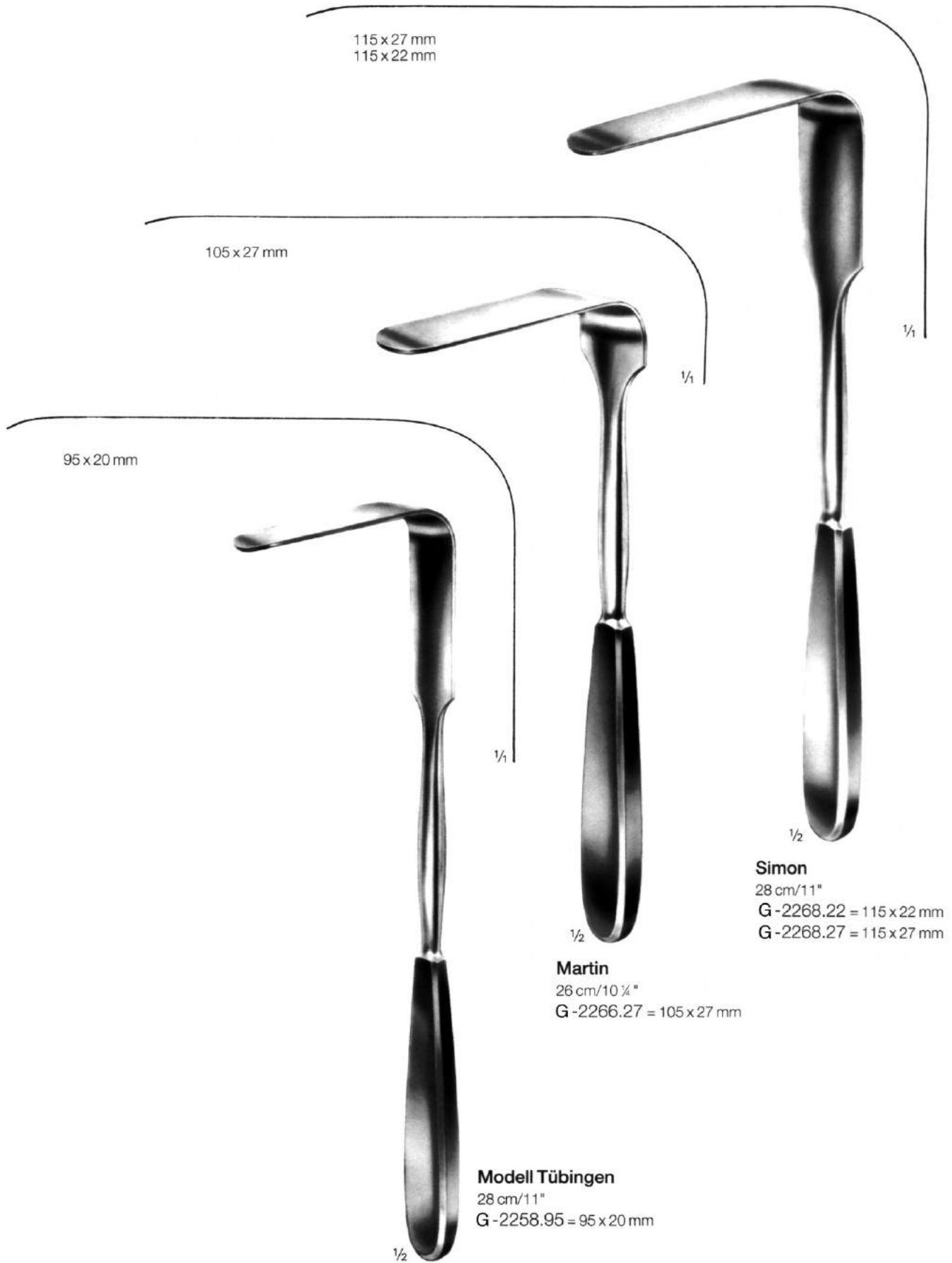



Fig.

1	G -3435.06	60 x 35 mm
2	G -3435.09	90 x 35 mm
3	G -3435.12	120 x 35 mm
4	G -3435.14	140 x 35 mm
5	G -3435.16	160 x 35 mm
6	G -3435.18	180 x 35 mm

1	G -3445.06	60 x 45 mm
2	G -3445.09	90 x 45 mm
3	G -3445.12	120 x 45 mm
4	G -3445.14	140 x 45 mm
5	G -3445.16	160 x 45 mm
6	G -3445.18	180 x 45 mm

1	G -3460.06	60 x 60 mm
2	G -3460.09	90 x 60 mm
3	G -3460.12	120 x 60 mm
4	G -3460.14	140 x 60 mm
5	G -3460.16	160 x 60 mm
6	G -3460.18	180 x 60 mm

Fig.

1	G -3535.06	60 x 35 mm
2	G -3535.09	90 x 35 mm
3	G -3535.12	120 x 35 mm
4	G -3535.13	130 x 35 mm

1	G -3545.06	60 x 45 mm
2	G -3545.09	90 x 45 mm
3	G -3545.12	120 x 45 mm
4	G -3545.13	130 x 45 mm

1	G -3560.06	60 x 60 mm
2	G -3560.09	90 x 60 mm
3	G -3560.12	120 x 60 mm
4	G -3560.13	130 x 60 mm

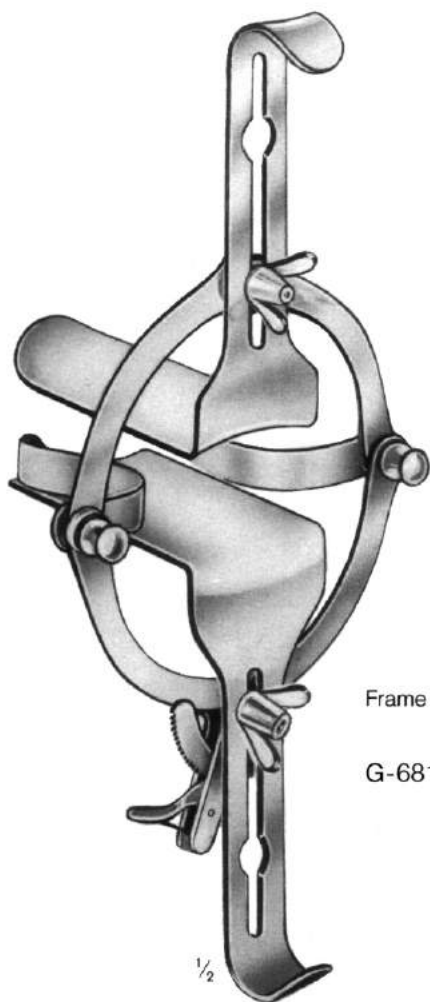

Frame only

G-6810.00

1/2

blades only

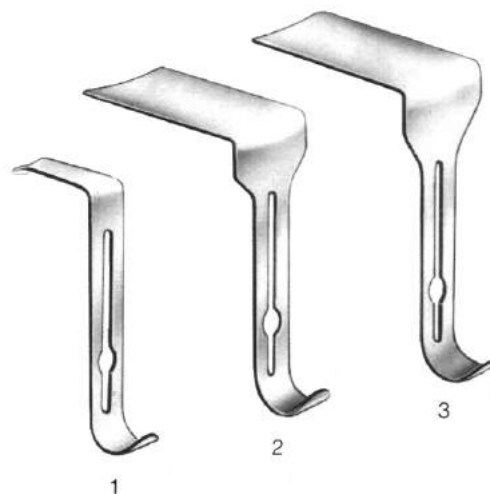

Fig.	a mm	b mm	
1	44	15	G-6810.15
2	85	39	G-6810.39
3	85	45	G-6810.45

O'Sullivan-O'Connor

- G-6810.10
complete with 3 blades
- G-6810.15
- G-6810.39
- G-6810.45



Gelpi

9 cm/3 1/2" = G-6830.09
11 cm/4 1/4" = G-6830.11
14 cm/5 1/2" = G-6830.14

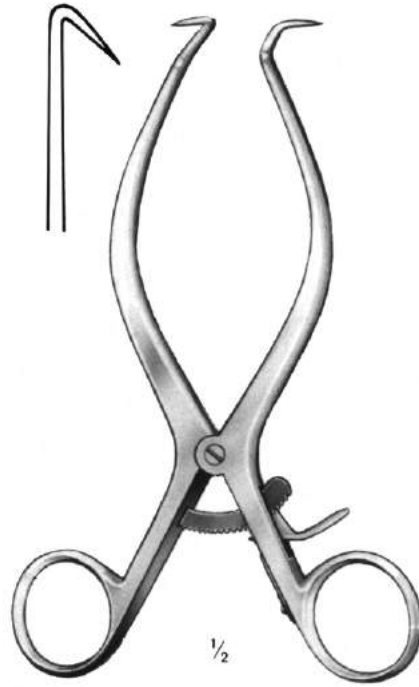

Gelpi

19 cm/7 1/2"
G-6830.19

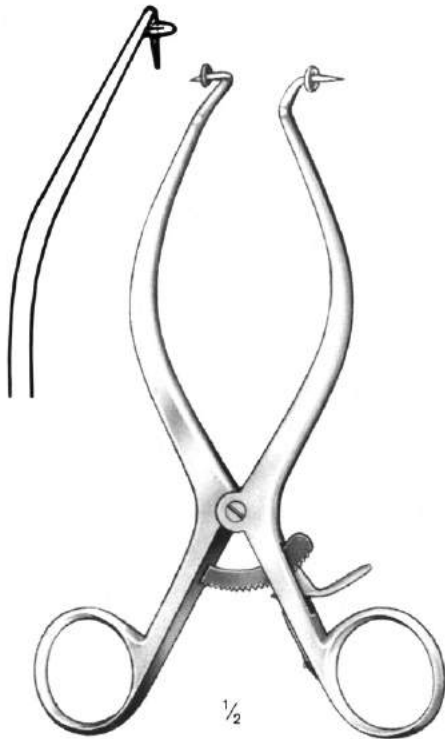

Gelpi

19 cm/7 1/2"
G-6832.19

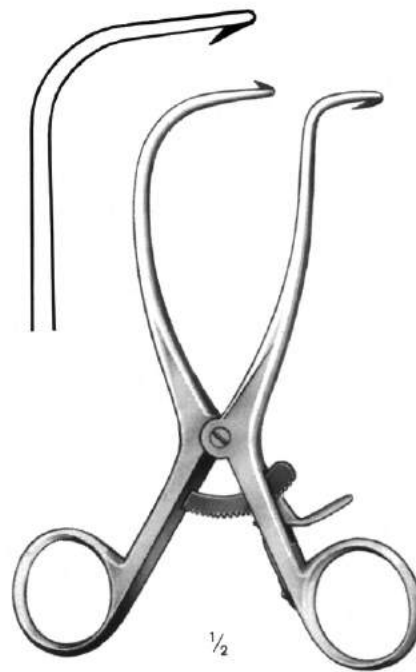

Seletz-Gelpi

15 cm/6"
G-6834.15



Gil-Vernet
24,5 cm/9 3/4"



JOLL (FRIEDMAN)
G-2828.16
15.5 cm

9 mm



G-2624.09

11 mm



G-2624.11

13 mm



1/4
G-2624.13

15 mm



G-2624.15

18 mm



G-2624.18

malleable



Gil-Vernet
28 cm/11"

9 mm



G-2628.09

11 mm



G-2628.11

13 mm



1/4
G-2628.13

15 mm



G-2628.15

18 mm



G-2628.18

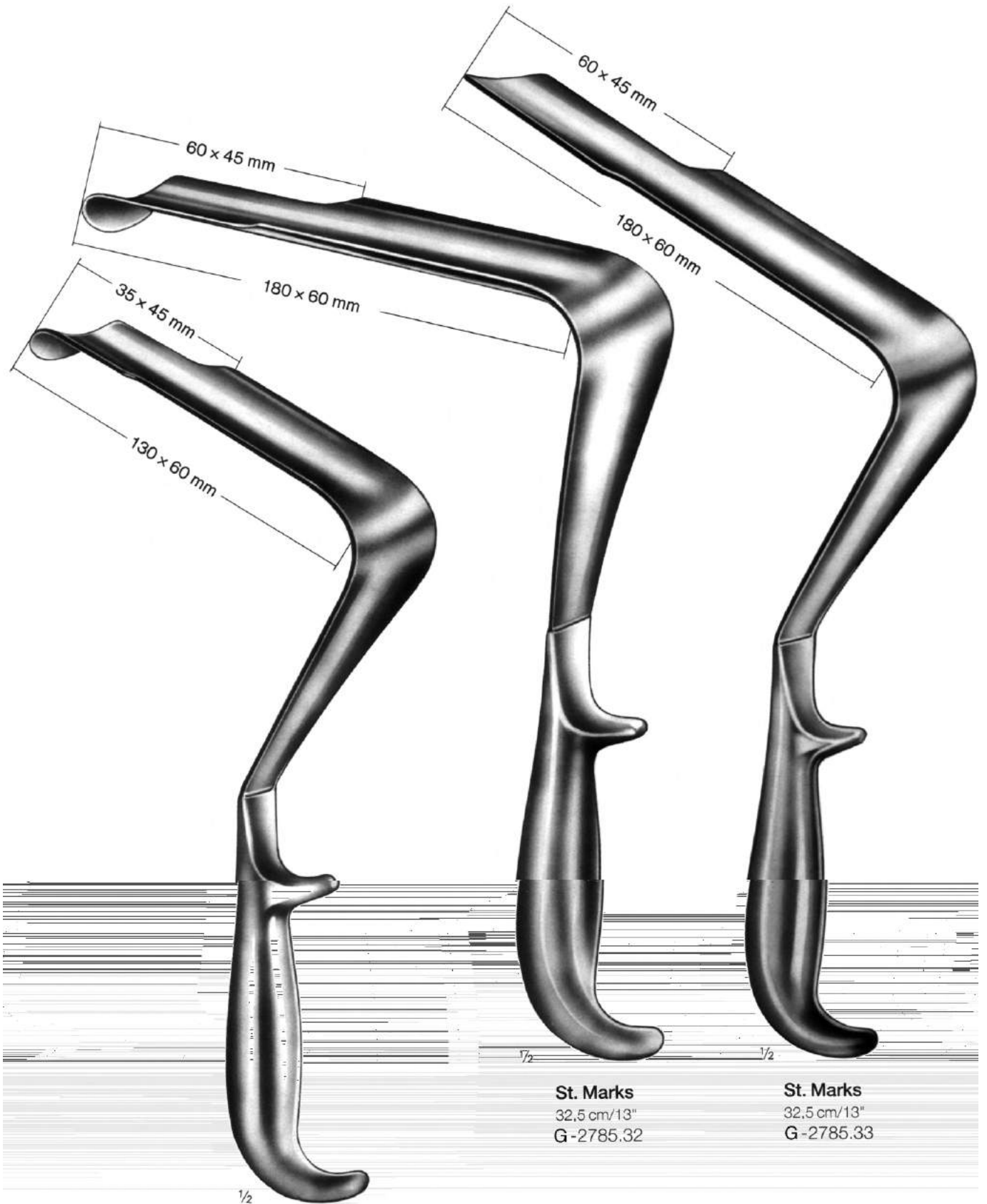

St. Marks
29 cm/11 1/2"
G-2785.29

St. Marks
32.5 cm/13"
G-2785.32

St. Marks
32.5 cm/13"
G-2785.33



Legueu
27 cm/10 1/2"
G-3210.27



Kocher
26 cm/10 1/4"
G-3220.26



Kocher
26 cm/10 1/4"
G-3230.26

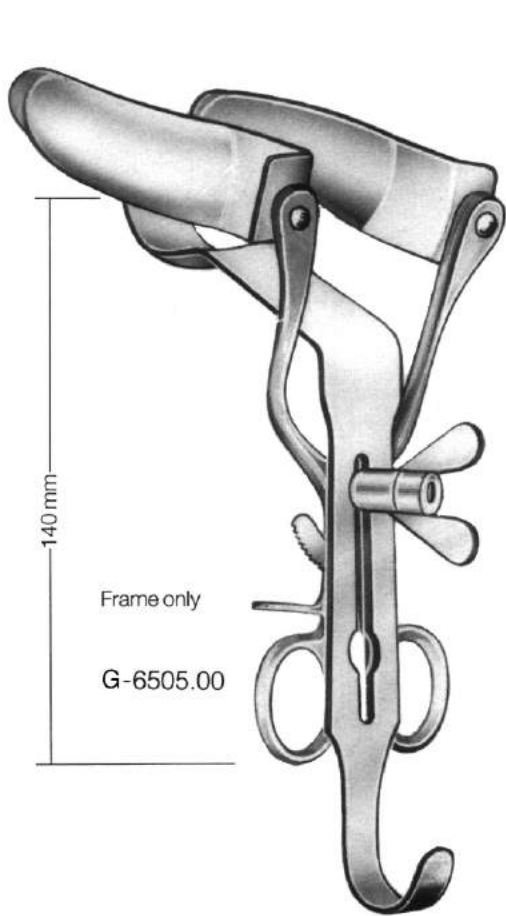

Frame only
G-6505.00



Sphincter blades
Pair
G-6505.09



Rectal blades
Pair
G-6505.07

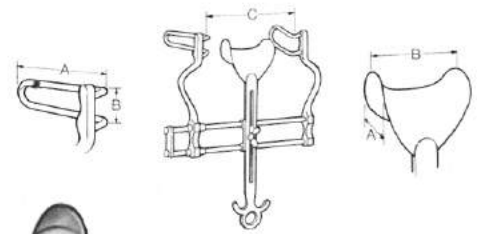

Alan Parks

G-6505.10

complete consisting of:

- 1, frame 140 mm, 5 1/2": **G-6505.00**
- 1, pair of blades, 75 x 24 mm: **G-6505.07**
- 1, pair of blades, 95 x 24 mm: **G-6505.09**
- 1, center blade, 95 x 24 mm: **G-6505.95**

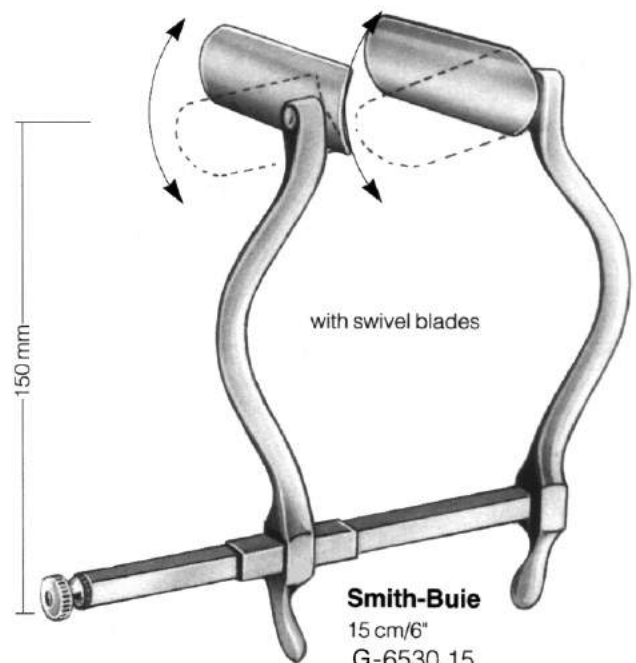

Smith-Buie
 15 cm/6"
G-6530.15

complete	lateral blades			Center blade			blade opening
Ref.	Ref.	A	B	Ref.	A	B	C
G-6505.10	G-6505.07 G-6505.09	75 mm 95 mm	24 mm 24 mm	G-6505.95	95 mm	24 mm	70 mm
G-6530.15		70 mm	22 mm				125 mm

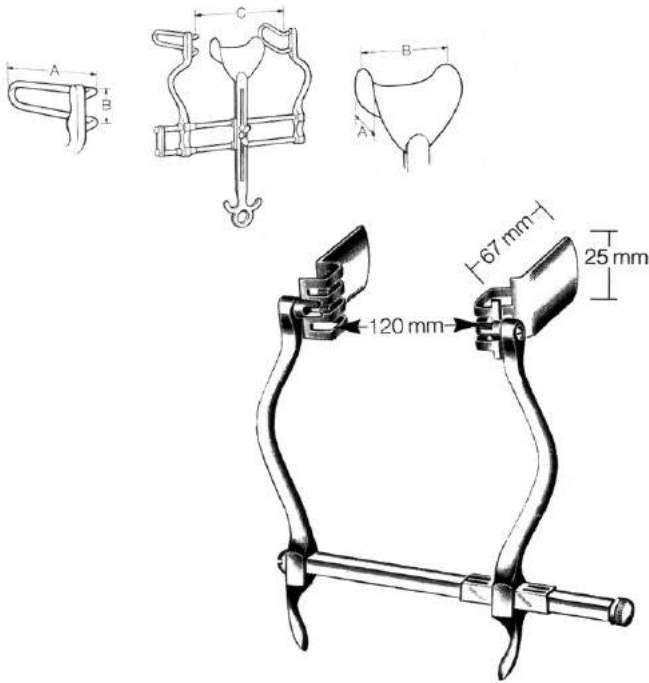

Judd-Masson
 G-6610.10

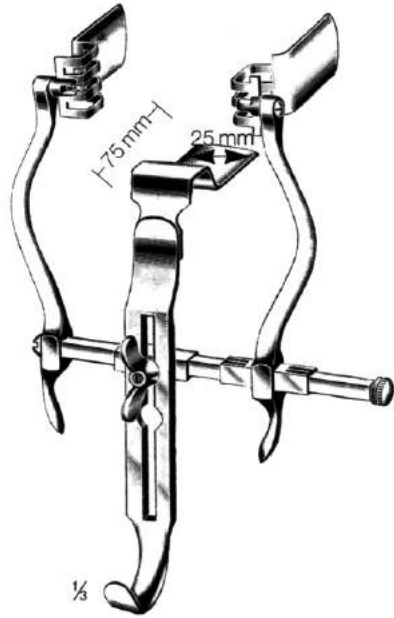

center blade
 G-6620.25

Judd-Masson
 G-6620.10

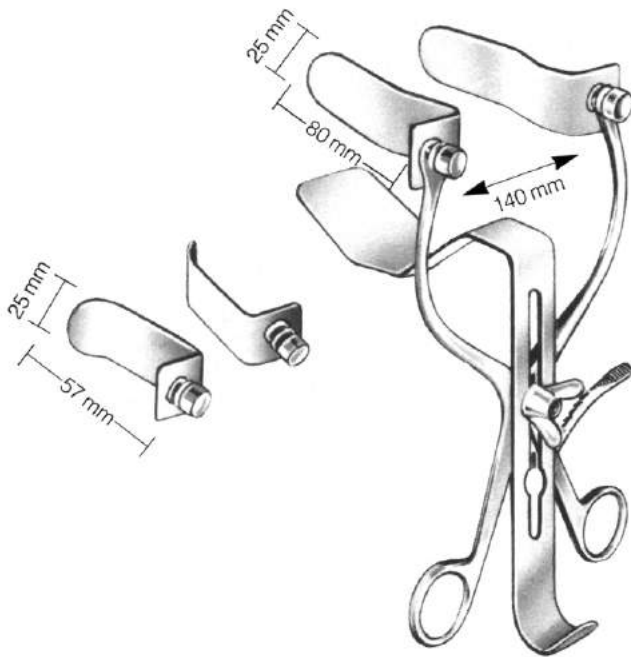

Millin
 G-6630.10

consisting of/
 G-6630.00, frame,
 G-6630.57, 2, blades, 57 x 25 mm
 G-6630.80, 2, blades, 80 x 25 mm
 G-6631.20, 1, blade, 120 x 45 mm

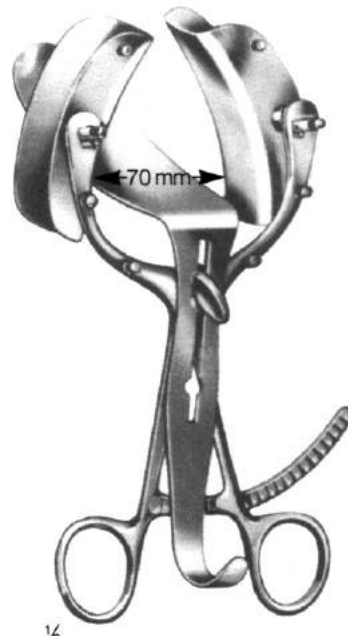

28 x 60 mm
 1 1/8" x 2 3/8"
 lateral blades, pair
 G-6660.28

70 x 32 mm
 2 3/4" x 1 1/4"
 center blade
 G-6660.70

Frame only
 G-6660.90

Legueu
 G-6660.10
 complete

Sternotomy spreaders aluminium
Ecarteurs à sternotomie, aluminium
Separadores para esternotomía, aluminio

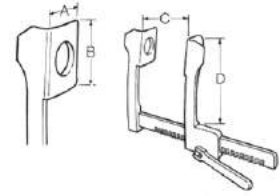

for new-born



Castañeda

	A	B	C
G-7500.65	10,5 mm	32 mm	65 mm

pediatric size



Castañeda

	A	B	C
G-7500.70	12 mm	45 mm	70 mm

child size



Castañeda

	A	B	C
G-7501.20	15 mm	60 mm	120 mm

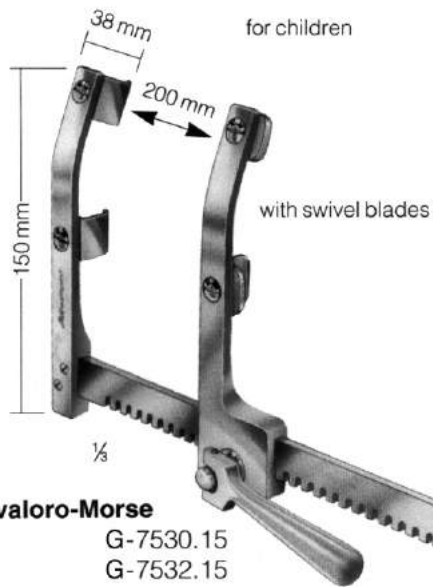
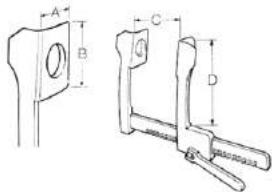

Favaloro-Morse
 G-7530.15
 G-7532.15

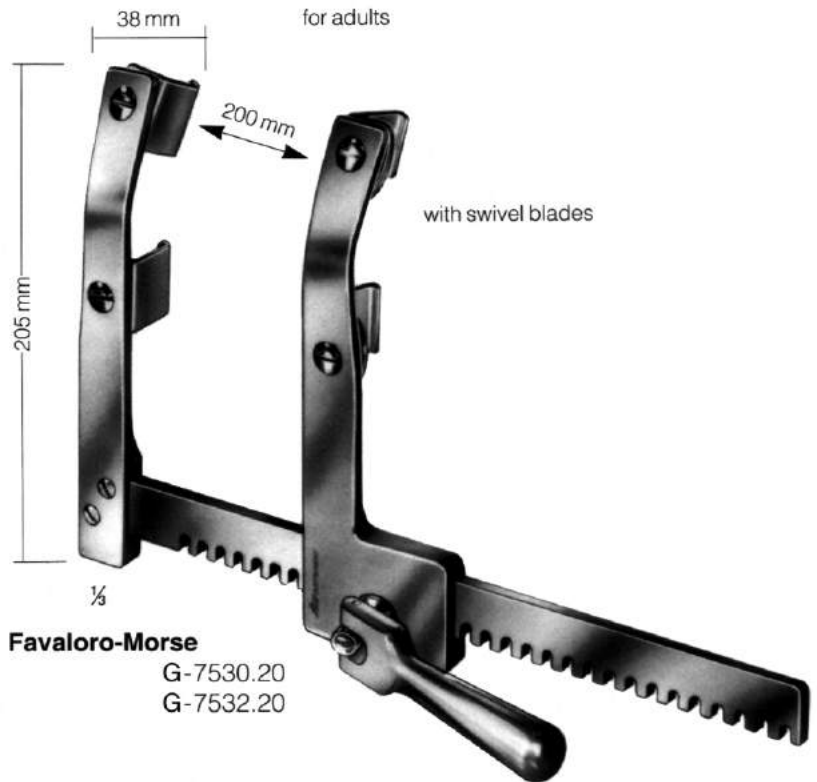

Favaloro-Morse
 G-7530.20
 G-7532.20



Morse modif.
 G-7531.20
 G-7533.20

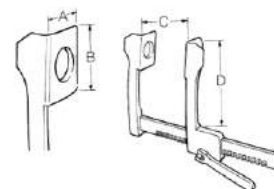

Cooley

	A	B	C
G-7610.75	12 mm, ½"	17 mm, ⅝"	75mm, 3"

for newborns



Cooley

	A	B	C
G-7611.05	16 mm, ⅝"	30 mm 1 ¼"	105 mm/4 ¼"

pediatric size

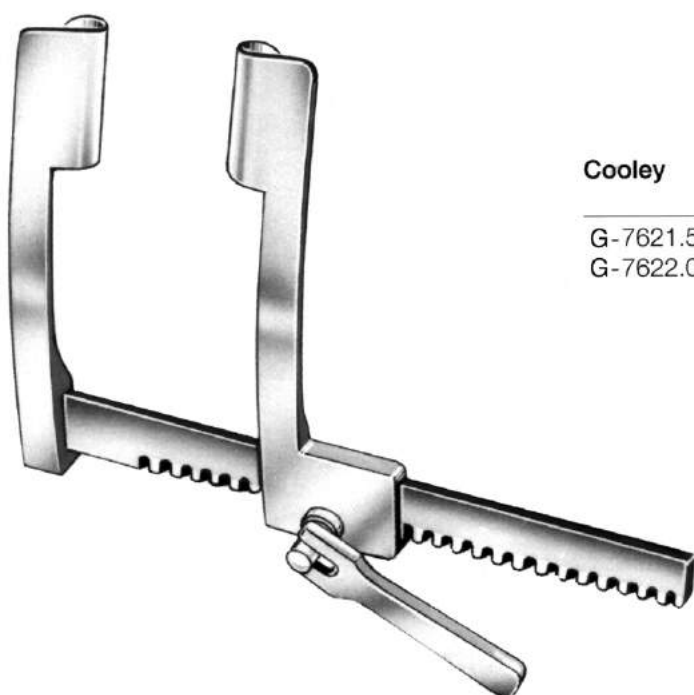

Cooley

	A	B	C
G-7621.50	21 mm, ⅝"	44 mm, 1 ¼"	150 mm, 6"
G-7622.00	37 mm, 1 ½"	49 mm, 1 ⅞"	200 mm/8"

G-7621.50 for children

G-7622.00 for adults

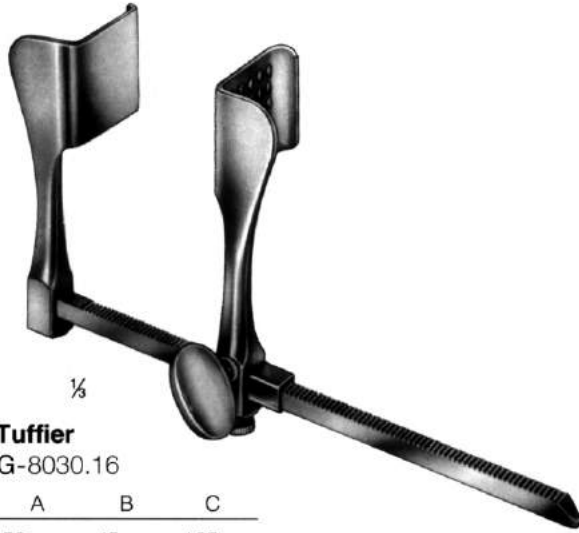

Tuffier
G-8030.16

A	B	C
50 mm	45 mm	165 mm

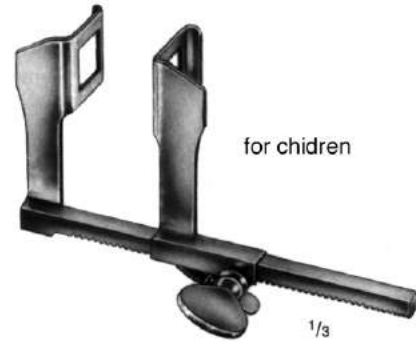
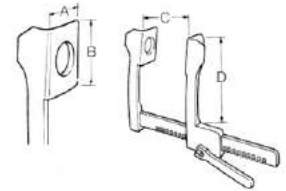

Baby-Haight
G-8040.90

A	B	C	D
30 mm	30 mm	90 mm	90 mm

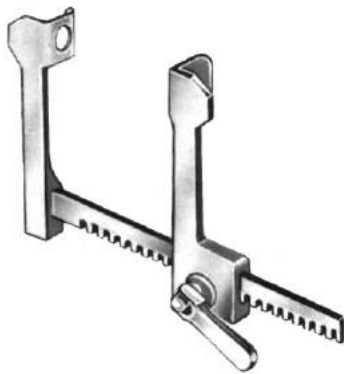

Finochietto-Baby

	A	B	C
G-8060.36			36 mm
G-8060.75			75 mm
G-8061.00	7 mm	7 mm	100 mm
G-8061.25			125 mm
G-8061.50			150 mm

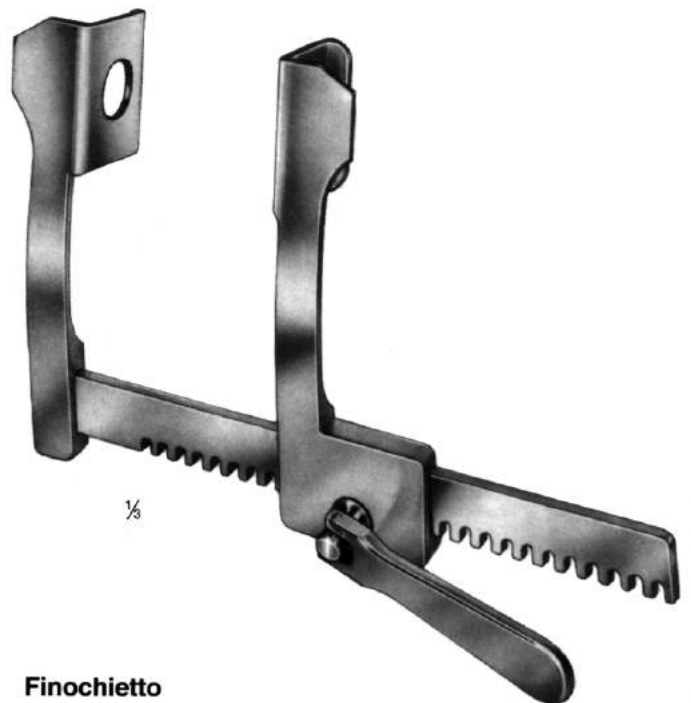

Finochietto

	A	B	C
G-8213.38	38 mm	44 mm	150 mm
G-8217.52	52 mm	62 mm	175 mm
G-8217.65	65 mm	85 mm	175 mm

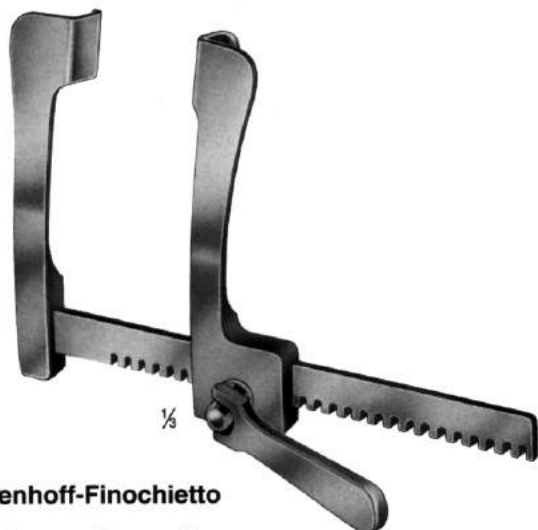
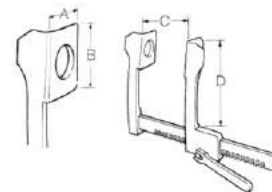

Rienhoff-Finochietto

A	B	C
21 mm	26 mm	150 mm

G-8415.26

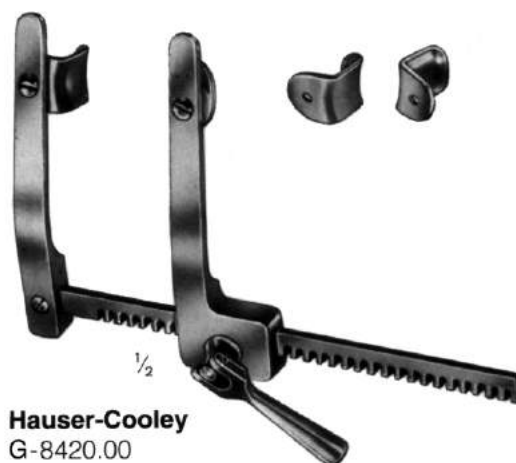

Hauser-Cooley
G-8420.00

for children

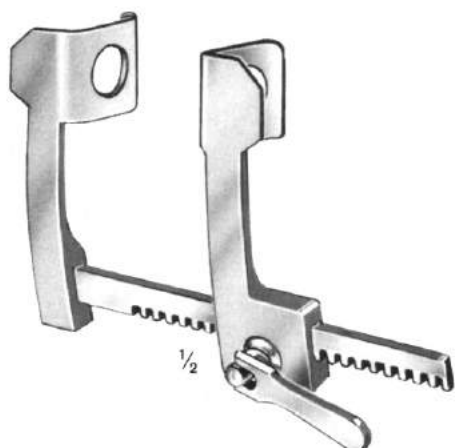

Finochietto-Baby-Haight

A	B	C
31 mm/1 ¼"	31 mm/1 ¼"	100 mm/4"

G-8470.10



DeBoer

A	B	C
27 mm	100 mm	190 mm

G-8560.19

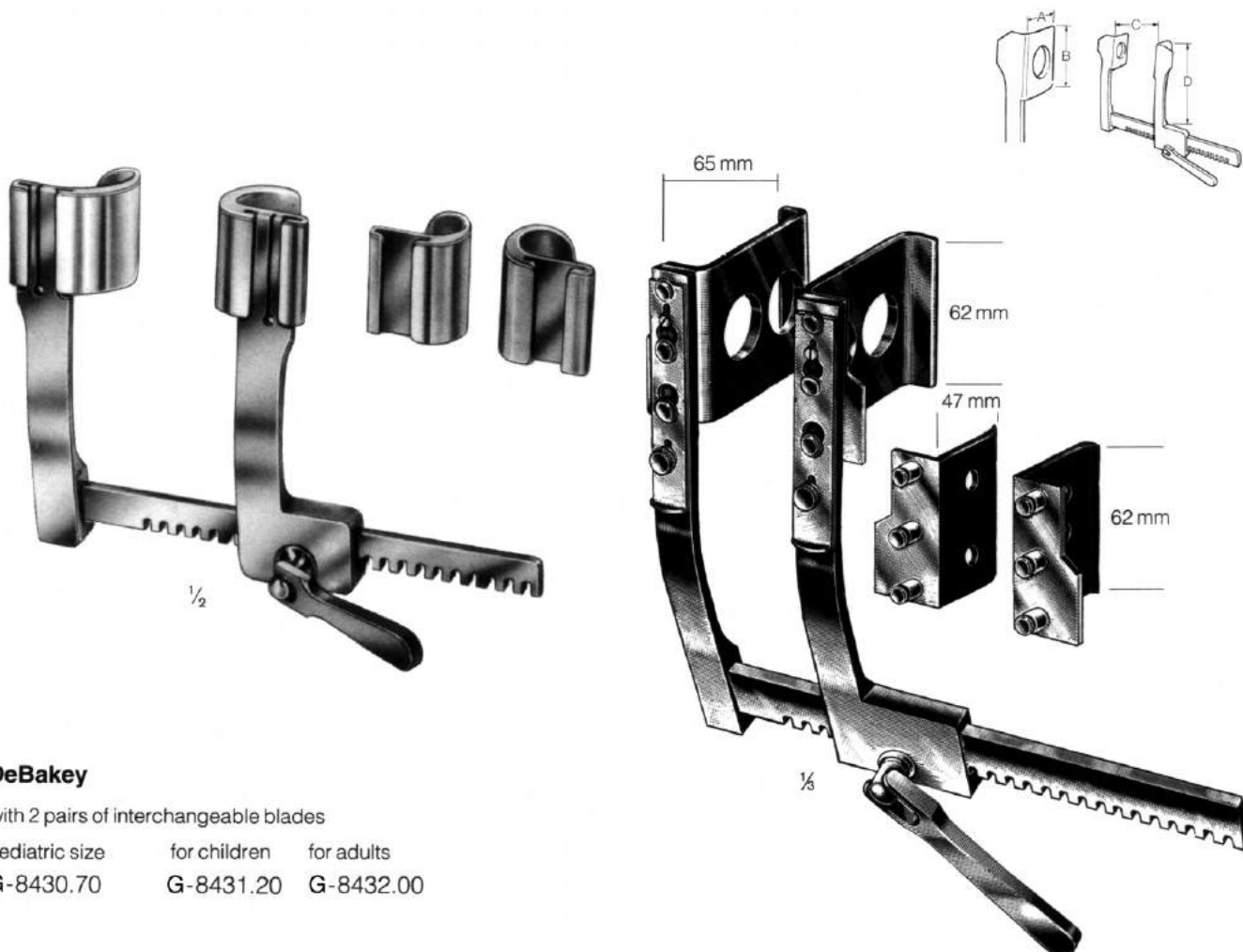

DeBakey

with 2 pairs of interchangeable blades

pediatric size

for children

for adults

G-8430.70

G-8431.20

G-8432.00

Burford-Finochietto

with 2 pairs of interchangeable blades

G-8450.20

G-8450.25

G-8450.30

	1. pair of interchangeable blades		2. pair of interchangeable blades		blade opening
	A mm	B mm	A mm	B mm	C mm
G-8430.70	15	15	15	12	70
G-8431.20	30	30	30	21	120
G-8432.00	60	52	60	32	200
G-8450.20	65	62	47	62	200
G-8450.25	65	62	47	62	250
G-8450.30	65	62	47	62	300



	un-removable blades		blades for scapula		blade opening
	A	B	A	B	C
G-8482.00	45 mm/1 3/4"	75 mm/3"	40 mm/1 1/2"	50 mm/2"	200 mm/8"
G-8482.50	45 mm/1 3/4"	75 mm/3"	40 mm/1 1/2"	50 mm/2"	250 mm/10"

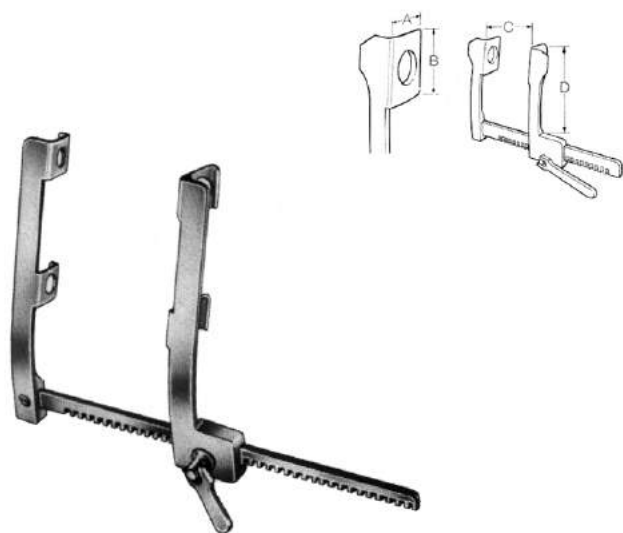

Finocchietto (modif.)

	A	B	C	D
G-9161.12	14 mm	14 mm	120 mm	110 mm



Finocchietto

	A	B	C
G-9213.38	38 mm	44 mm	135 mm
G-9217.52	52 mm	62 mm	175 mm
G-9217.85	85 mm	65 mm	175 mm

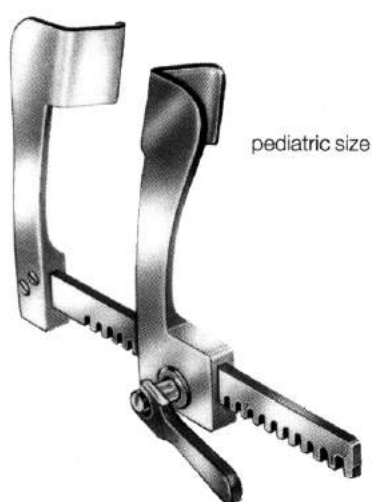

Cooley

	A	B	C
G-9410.21	21 mm	25 mm	105 mm

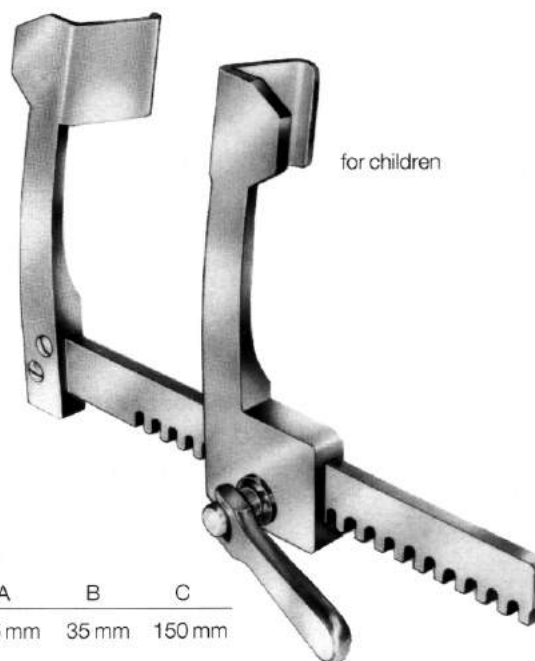

Cooley

	A	B	C
G-9415.35	35 mm	35 mm	150 mm

Rib spreader (aluminium)
Ecarteurs costaux, aluminium
Separadores costales, aluminio

pediatric size

with 2 pairs of interchangeable blades

for children

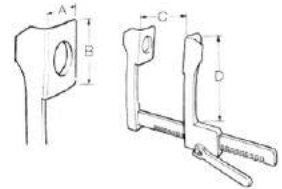

Cooley
G-9420.00



Burford-Finochietto
Baby G-9451.13

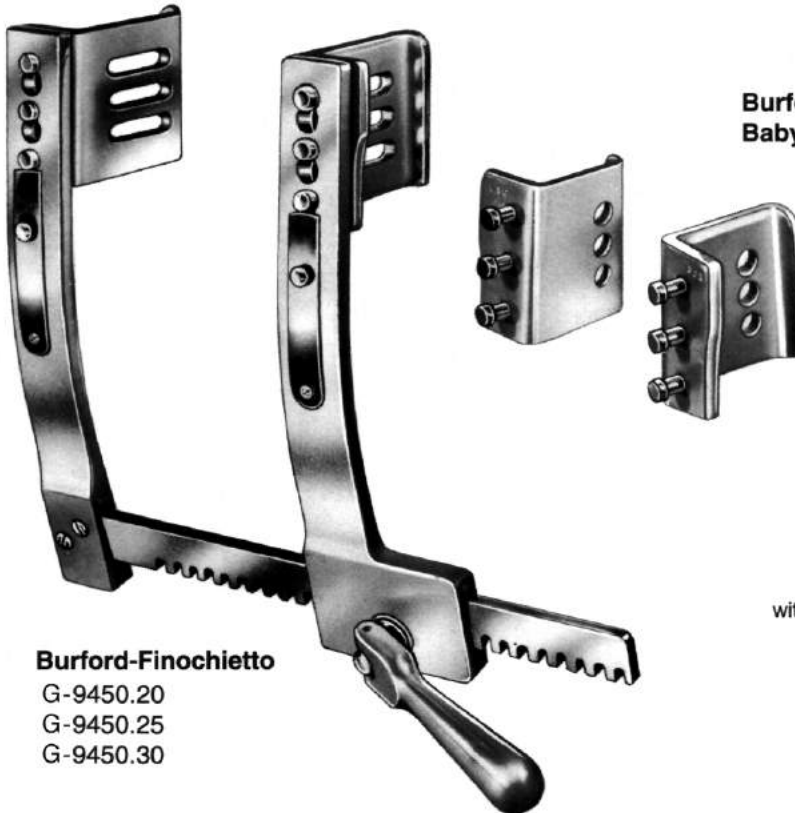

Burford-Finochietto
G-9450.20
G-9450.25
G-9450.30

with 2 pairs of interchangeable blades

	1. pair of interchangeable blade		2. pair of interchangeable blades		blade opening
	A	B	A	B	C
G-9450.20	65 mm	62 mm	47 mm	62 mm	200 mm, 8"
G-9450.25	65 mm	62 mm	47 mm	62 mm	255 mm, 10"
G-9450.30	65 mm	62 mm	47 mm	62 mm	305 mm, 12"
G-9451.13	48 mm	42 mm	34 mm	42 mm	135 mm, 5 1/4"

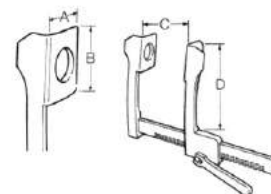

for babies



Finochietto-Infant
 G-9464.75

A	B	C
15 mm	15 mm	75 mm

for children



Finochietto-Baby-Haight
 G-9470.10

A	B	C
31 mm	31 mm	100 mm

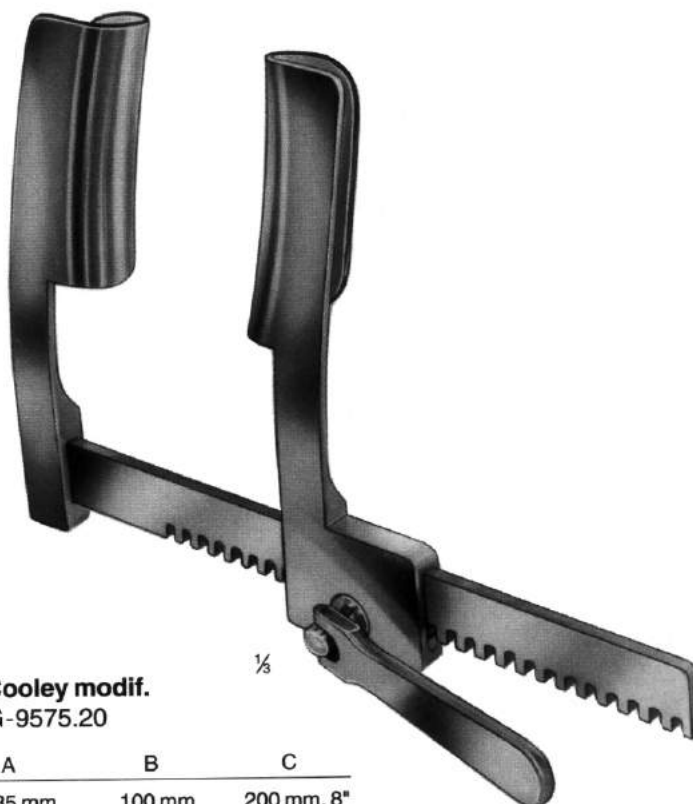

Cooley modif.
 G-9575.20

A	B	C
35 mm	100 mm	200 mm, 8"

Rib Spreader and contractor

Sternal Approximator



1/2

Bailey-Baby
 14,5 cm/5 3/4"
 G-9900.14



1/2

Bailey
 16 cm/6 1/4"
 G-9900.16



1/2

Bailey-Gibbon
 16 cm/6 1/4"
 G-9910.16



1/2

Sellors
 19 cm/7 1/2"
 G-9960.20



1/2

Lemmon
 G-9970.14 = 14 cm/5 1/2"
 G-9970.18 = 18 cm/7"

Lung Spatulas, Scapula Retractors

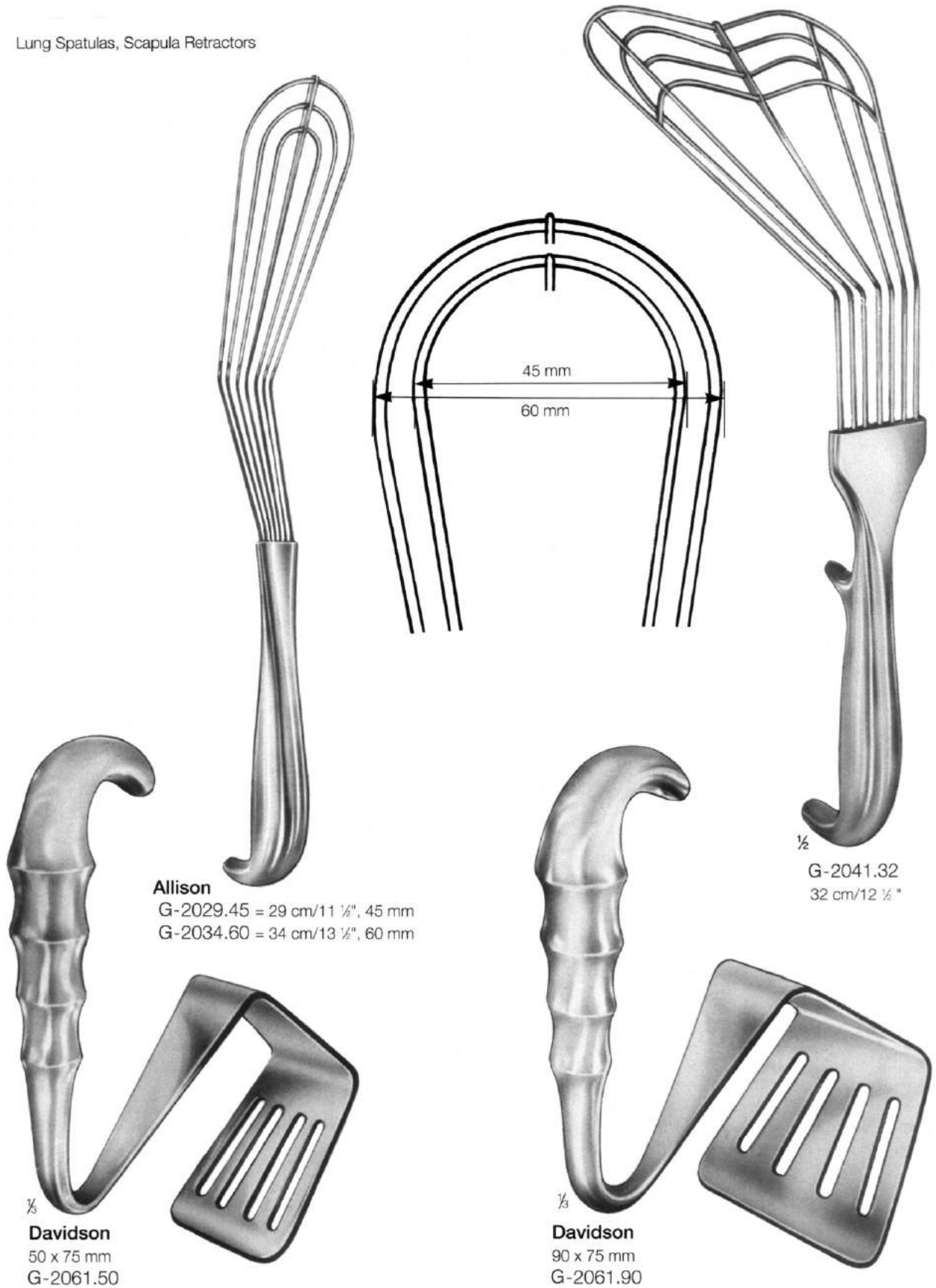

Tourniquets



Rumel-Belmont 30 cm/12 "
 Ø 3,2 mm = G-3750.32
 Ø 6,4 mm = G-3750.64



without catch



Eyed stilette
 G-3750.82



Rumel-Belmont 30 cm/12 "
 Ø 3,2 mm = G-3752.32
 Ø 6,4 mm = G-3752.64



with catch



Eyed stilette
 G-3750.82

Atrial Retractors

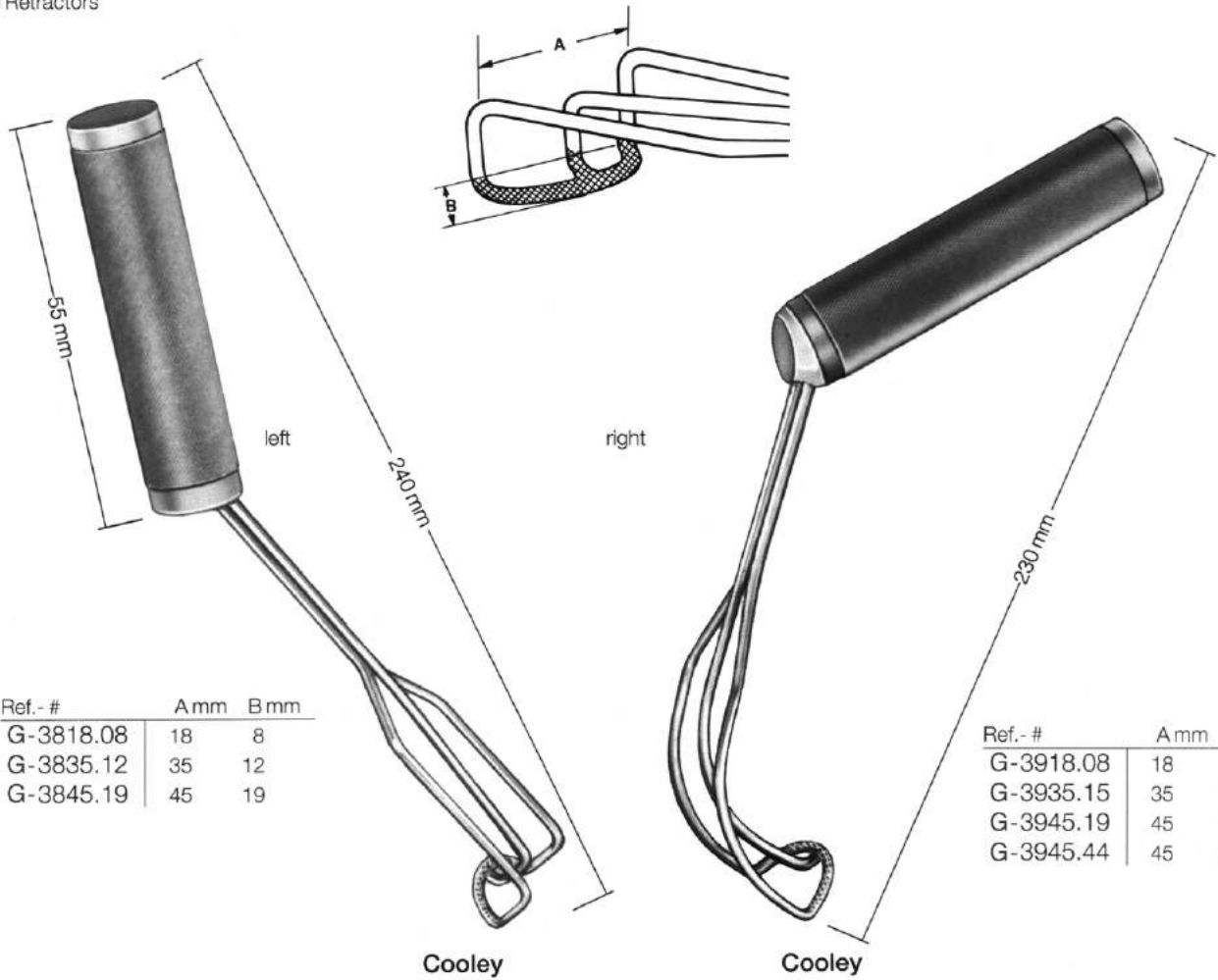

Ref. - #	A mm	B mm
G-3818.08	18	8
G-3835.12	35	12
G-3845.19	45	19

Ref. - #	A mm	B mm
G-3918.08	18	8
G-3935.15	35	15
G-3945.19	45	19
G-3945.44	45	44

Valve Dilators

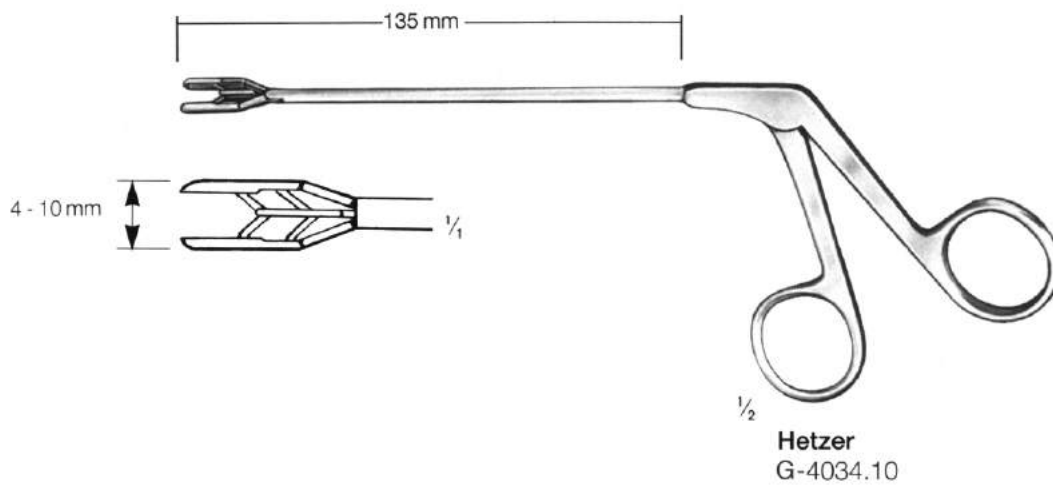

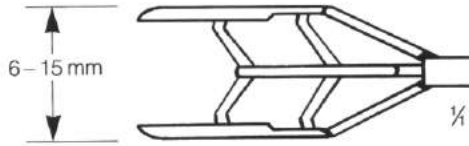

Cooley
G-4046.15

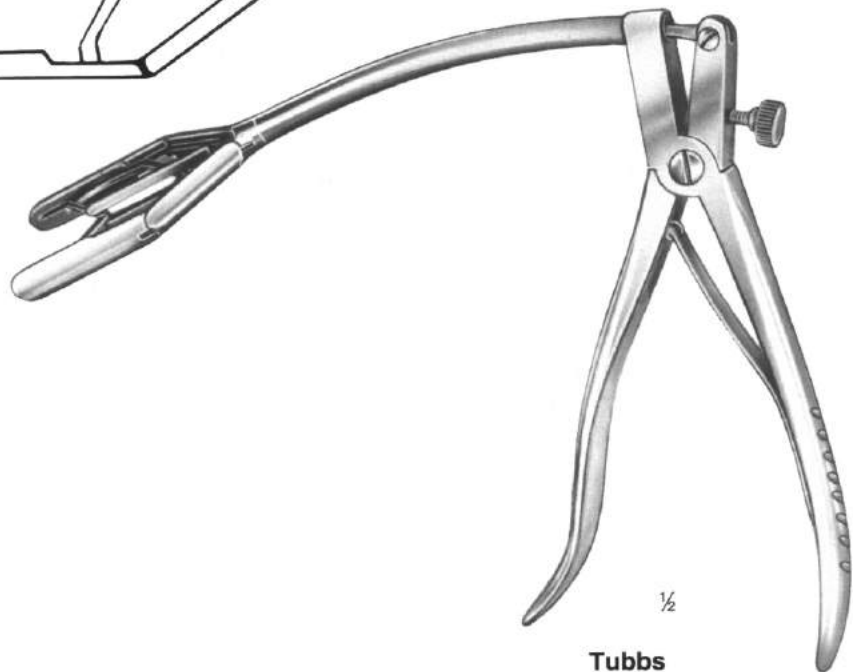
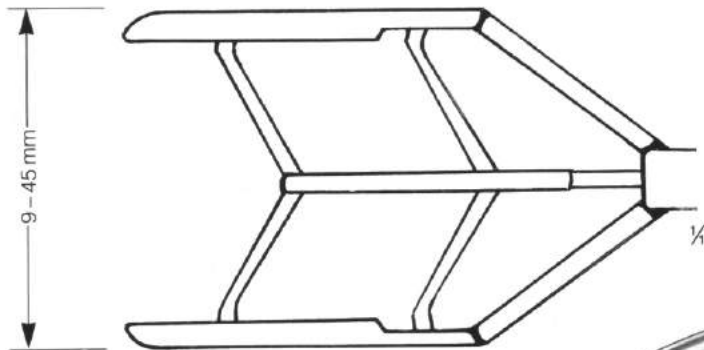

Tubbs
G-4069.45



14 cm/5 1/2"
G-0460.14

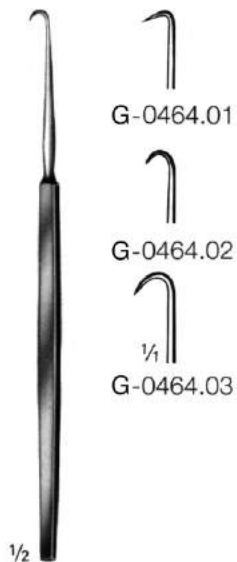

Cushing
14,5 cm/5 1/2"

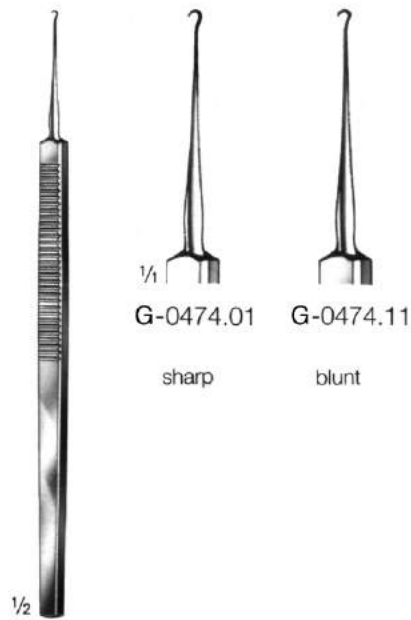

Graefe
16 cm/6 1/4"

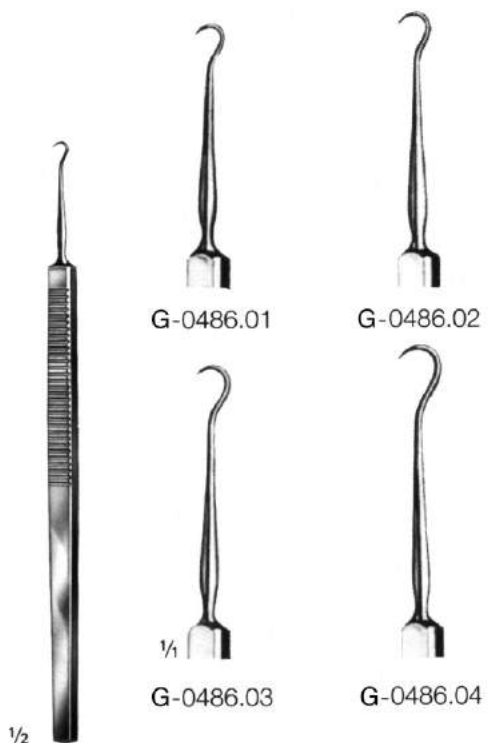

16 cm/6 1/4"

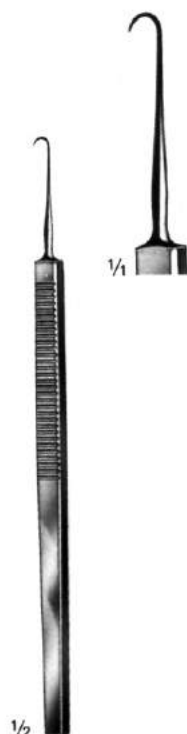

O'Connor
16 cm/6 1/4"
G-0050.16

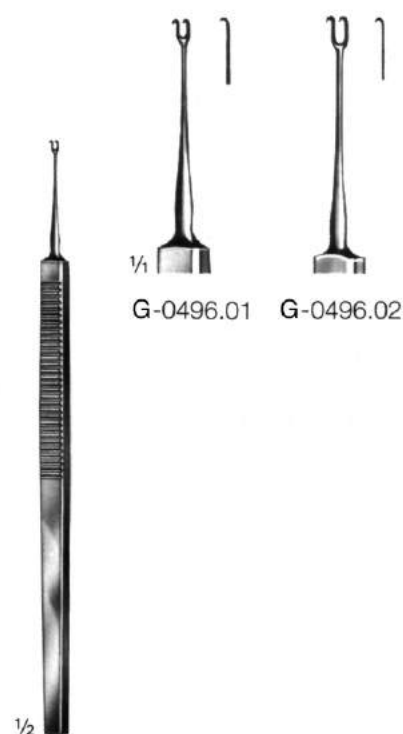

Guthrie
16 cm/6 1/4"

TTC

- Instruments with tungsten carbide inserts
- Instruments avec carbure de tungsten inséré
- Instrumentos con inserciones de tungsteno

As, surgical procedures call for a variety of needles and sutures. Therefore, we made available needleholders with Tungsten Carbide jaws that have different ground profiles.

- (A) 0.5 the normal serration** (for big needles and sutures up to 4/0)
- (B) 0.4 the fine serration** (for needles with smaller diameter and sutures up to 6/0)
- (C) 0.3 the micro-fine serration** (for very small needles and sutures up to 10/0)
- (D) smooth, without any serration** (can hold small and very small needles and sutures up to 10/0 rotate)

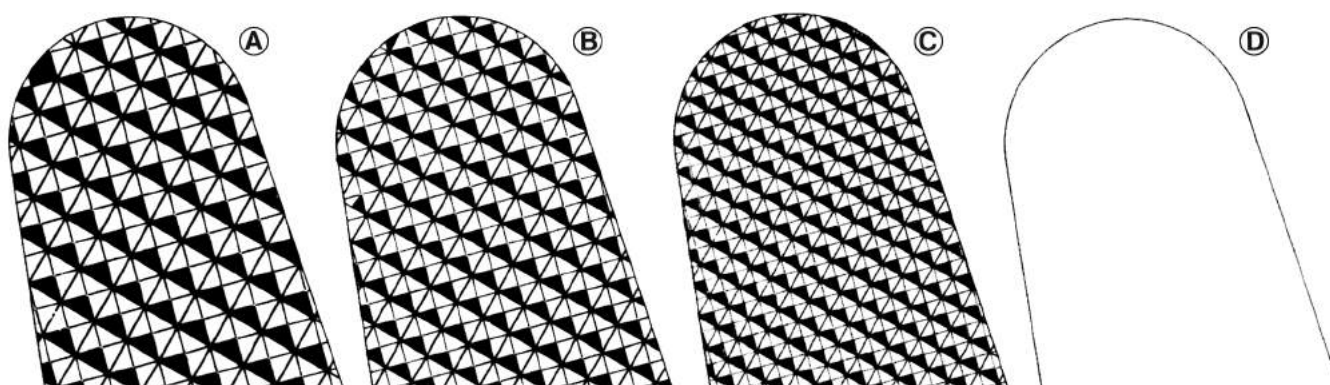

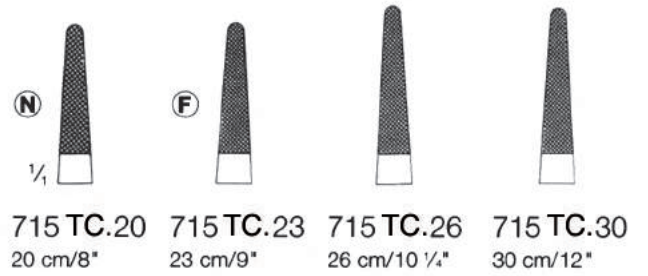
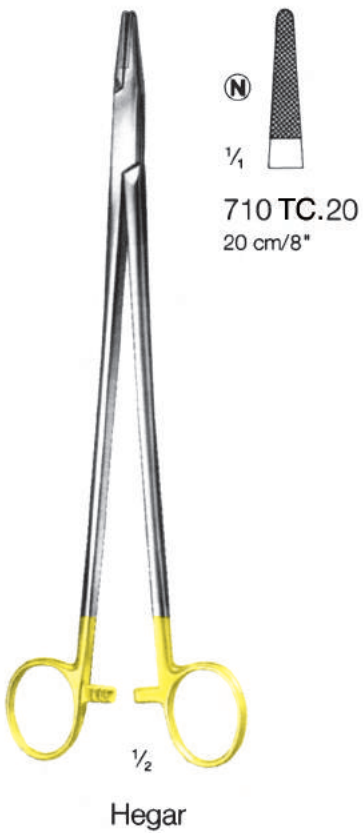







720 TC.24
 24 cm/9 1/2"

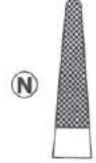

Mathieu





720 TC.14 **720 TC.17** **720 TC.20**
 14 cm/5 1/2" 17 cm/6 3/4" 20 cm/8"



Mathieu





721 TC.17 **721 TC.20** **721 TC.23**
 17 cm/6 3/4" 20 cm/8" 23 cm/9"

Mathieu





726 TC.20 **726 TC.23**
 20 cm/8" 23 cm/9"

Zweifel



Langenbeck



723 TC.16
16 cm/6 1/4"



723 TC.18
18 cm/7"



723 TC.20
20 cm/8"



Langenbeck

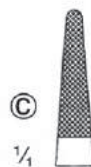

724 TC.20
20 cm/8"

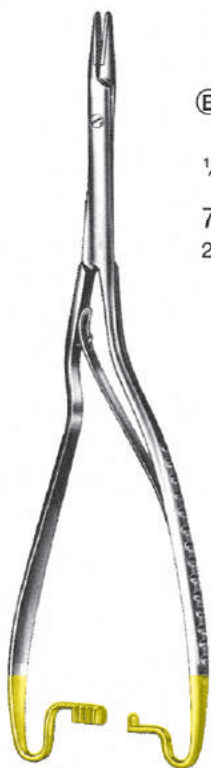

Lütthy-Beck

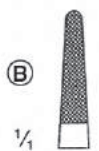

728 TC.20
20 cm/8"



728 TC.23
23 cm/9"



728 TC.25
25 cm/10"

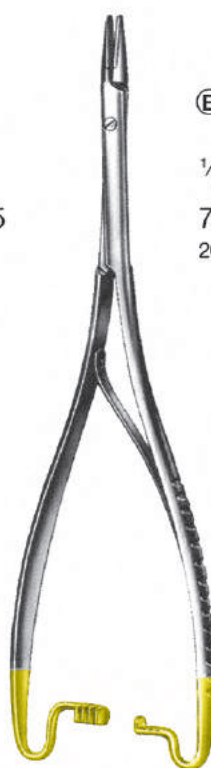

Hösel



735 TC.20
20 cm/8"



735 TC.23
23 cm/9"



735 TC.25
25 cm/10"

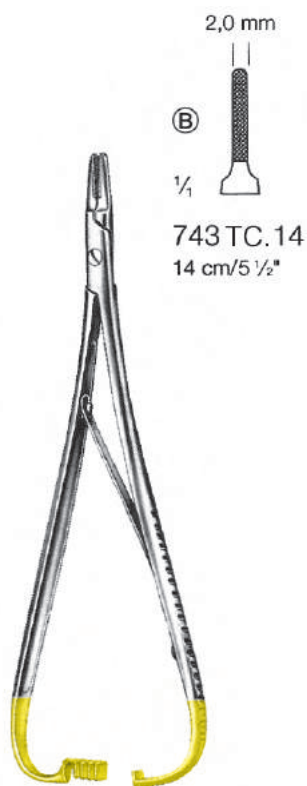

Lichtenberg-Ryder

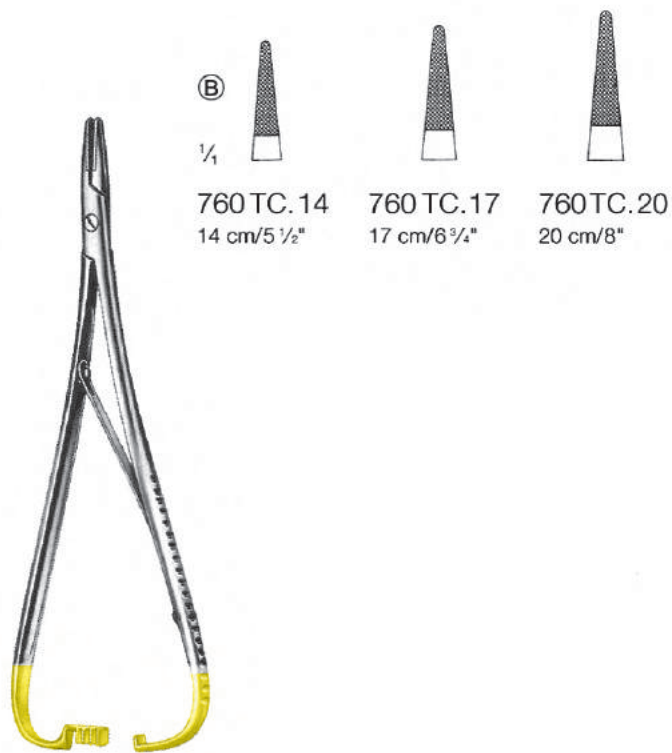
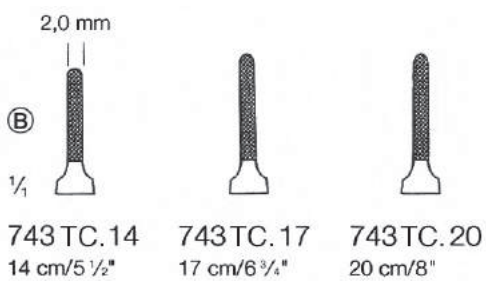

Lichtenberg

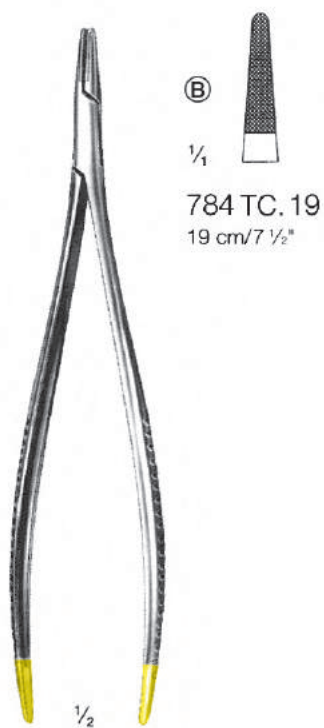
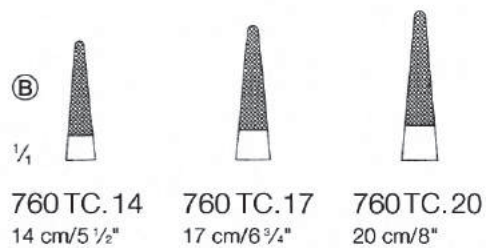

Tönnies

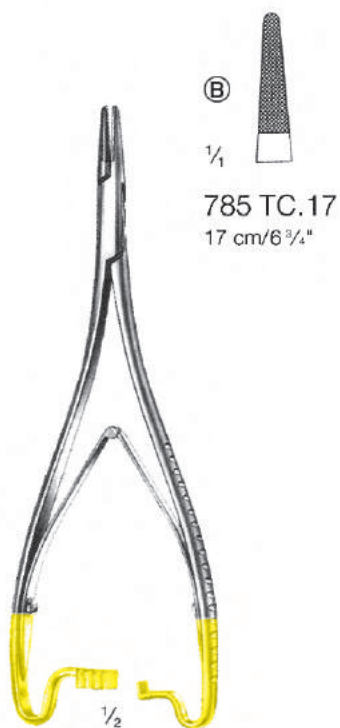
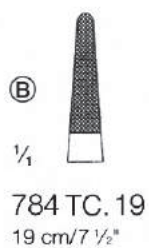

Mathieu-Grazil

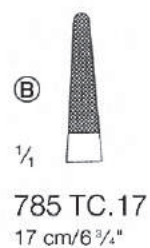



Mathieu-Stillie

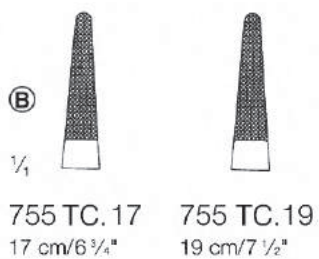

Metzenbaum

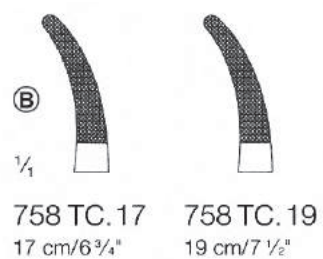

Swedish

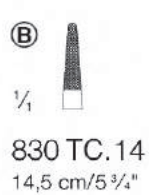

Senning

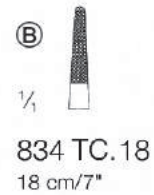

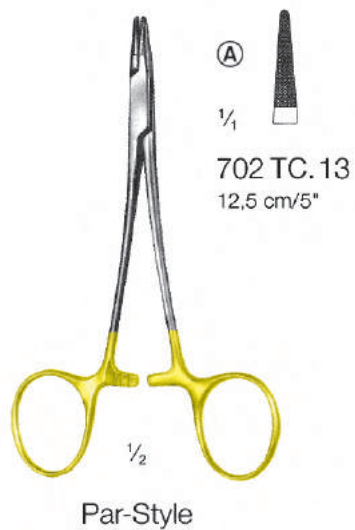

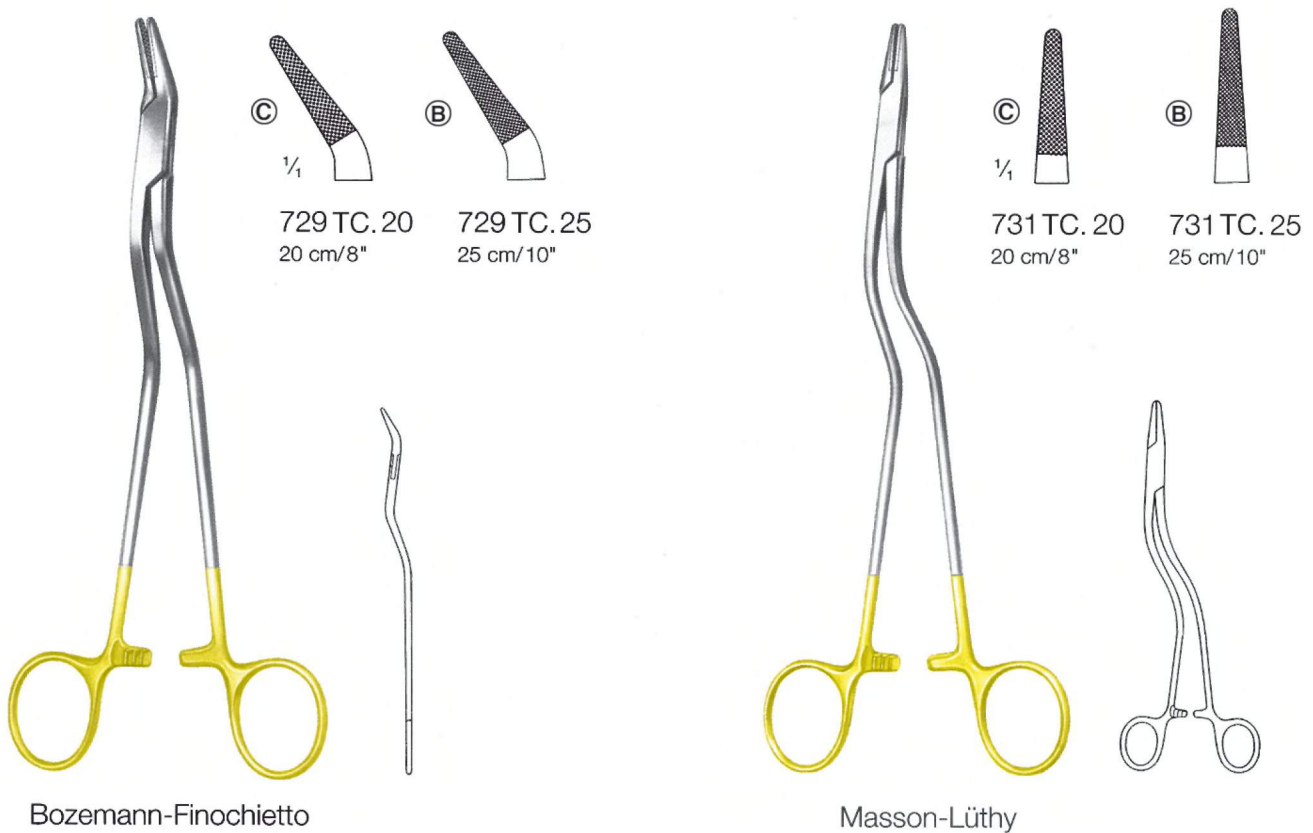
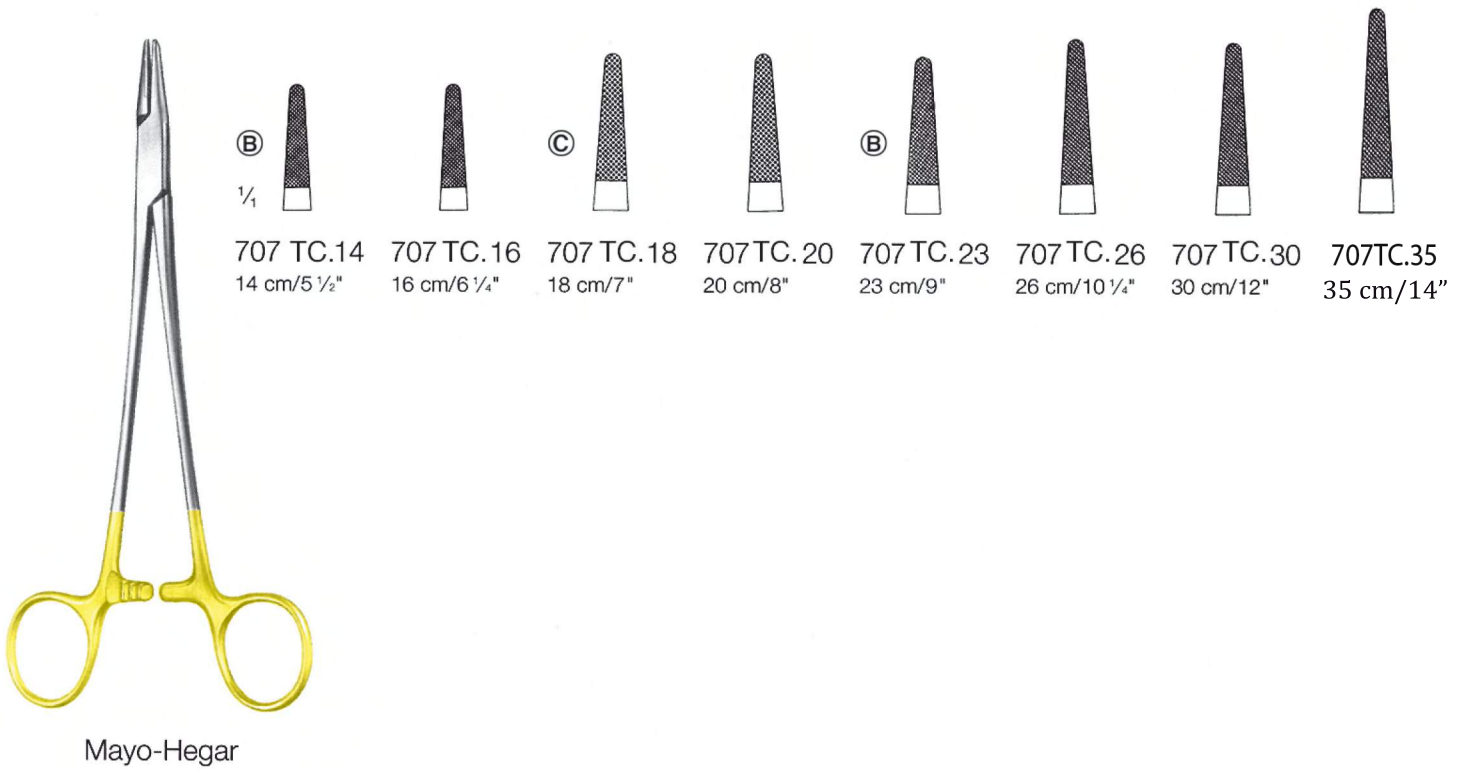

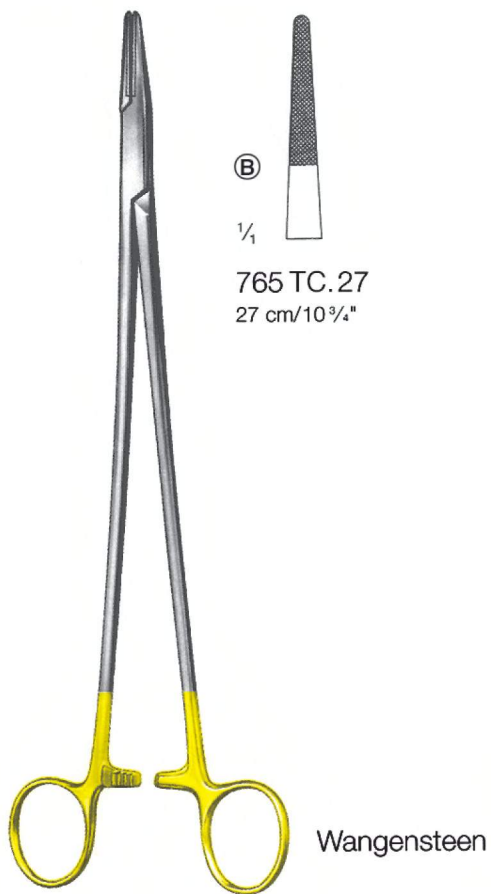
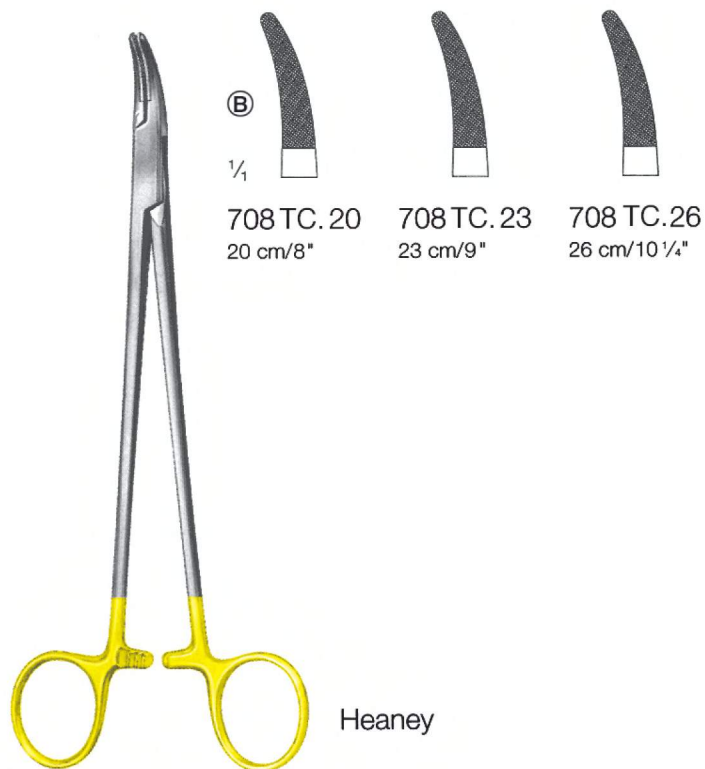





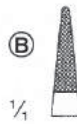

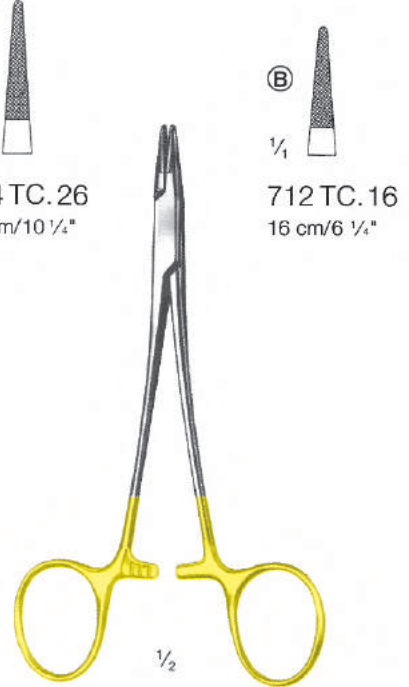

Crile-Wood (Newman)

 ① $\frac{1}{4}$	 $\frac{1}{4}$	 $\frac{1}{4}$	 $\frac{1}{4}$	 $\frac{1}{4}$
712 TC.15 15 cm/6"	734 TC.18 18 cm/7"	734 TC.20 20 cm/8"	734 TC.23 23 cm/9"	734 TC.26 26 cm/10 $\frac{1}{4}$ "







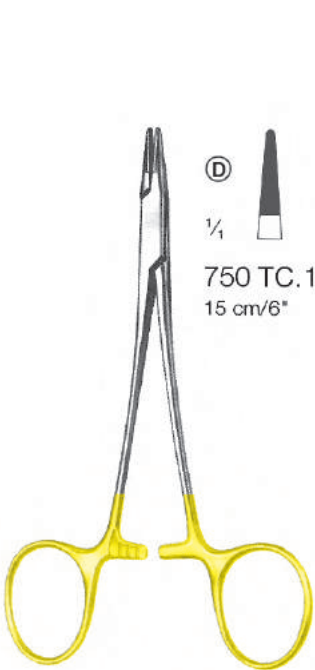

Crile-Wood (Newman)

 ① $\frac{1}{4}$
712 TC.16 16 cm/6 $\frac{1}{4}$ "



Crile-Wood

 ② $\frac{1}{4}$	 $\frac{1}{4}$	 ① $\frac{1}{4}$	 $\frac{1}{4}$	 $\frac{1}{4}$	 $\frac{1}{4}$	 $\frac{1}{4}$
750 TC.15 15 cm/6"	750 TC.18 18 cm/7"	770 TC.13 13 cm/5"	770 TC.15 15 cm/5"	770 TC.18 18 cm/7"	770 TC.20 20 cm/8"	770 TC.23 23 cm/9"

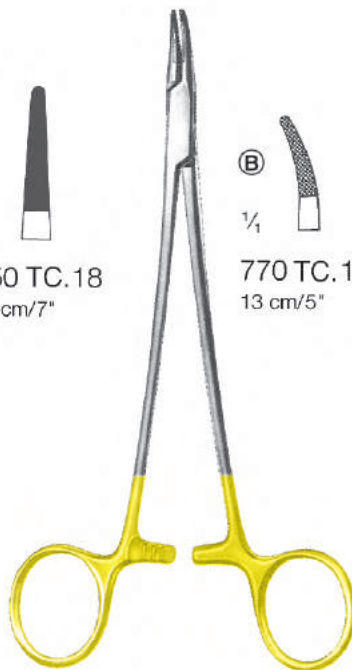

Crile-Wood

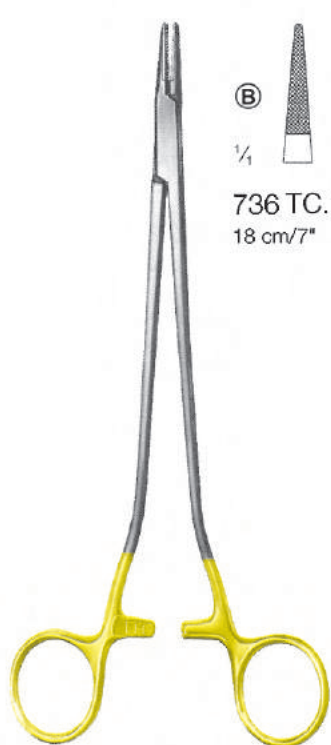

Sartorius

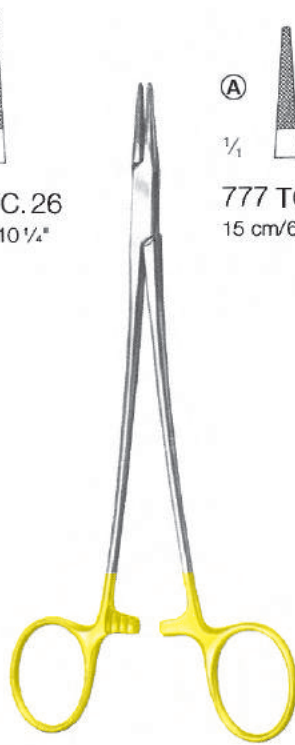
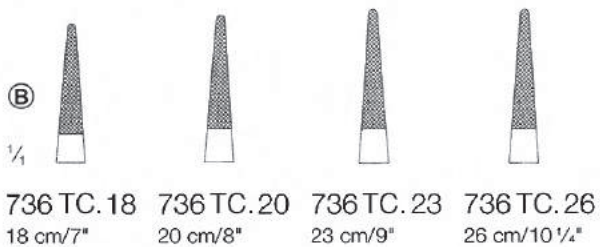

Micro-Vascular

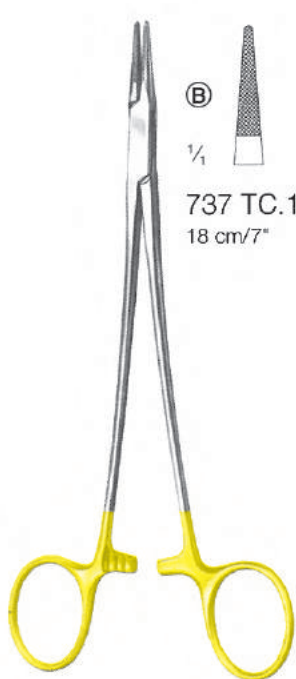
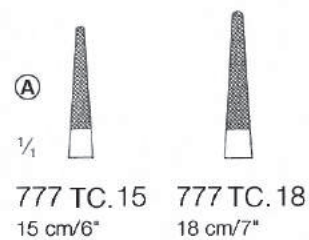

DeBakey

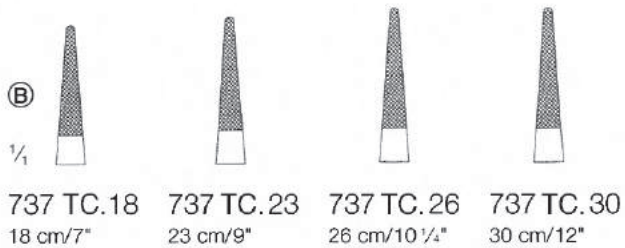



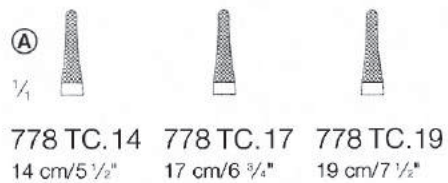

Lemmon













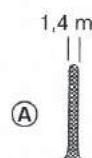

French eye (Ryder)

 <p>ⓑ</p> <p>1/4</p>			
<p>739 TC.16 16 cm/6 1/4"</p>	<p>739 TC.18 18 cm/7"</p>	<p>739 TC.20 20 cm/8"</p>	<p>739 TC.26 26 cm/10 1/4"</p>



Micro-Ryder

 <p>Ⓐ</p> <p>1,4 mm</p> <p>1/4</p>				
<p>740 TC.13 13 cm/5"</p>	<p>740 TC.15 15 cm/6"</p>	<p>740 TC.18 18 cm/7"</p>	<p>740 TC.20 20 cm/8"</p>	<p>740 TC.23 23 cm/9"</p>

 <p>Ⓓ</p> <p>1,4 mm</p> <p>1/4</p>				
<p>741 TC.13 13 cm/5"</p>	<p>741 TC.15 15 cm/6"</p>	<p>741 TC.18 18 cm/7"</p>	<p>741 TC.20 20 cm/8"</p>	<p>741 TC.23 23 cm/9"</p>

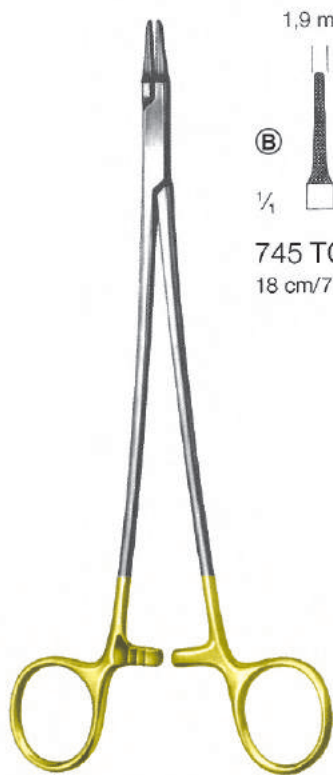

Intracardiac

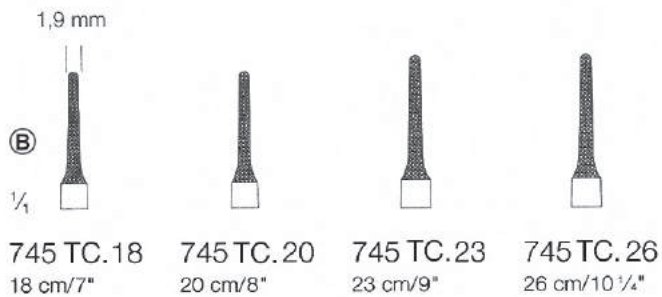

Neurosurgical

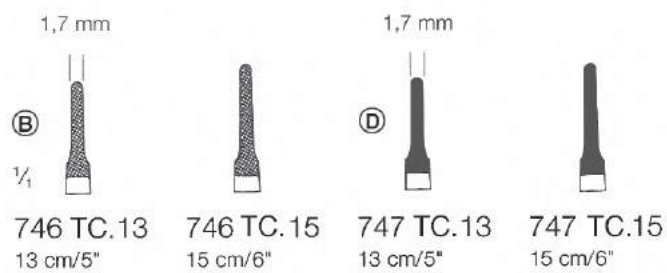



Gillies mini



775 TC.14
 14 cm/5 1/2"

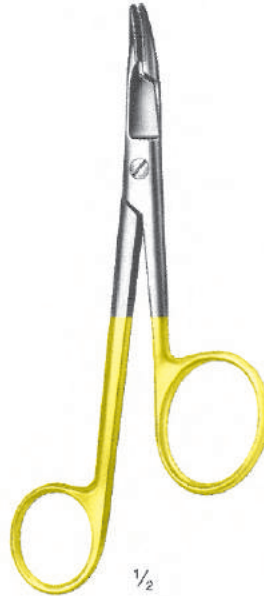

Gillies



775 TC.16
 16 cm/6 1/4"



Olsen-Hegar mini

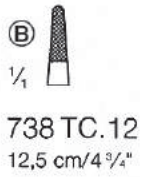

738 TC.12
 12,5 cm/4 3/4"

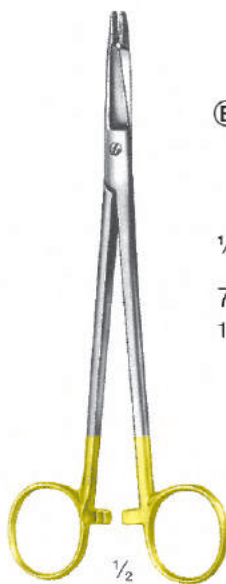

Olsen-Hegar

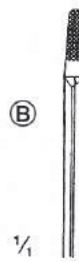

738 TC.16
 16 cm/6 1/4"



Olsen-Hegar

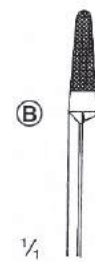

738 TC.14
 14 cm/5 1/2"



738 TC.18
 18 cm/7"

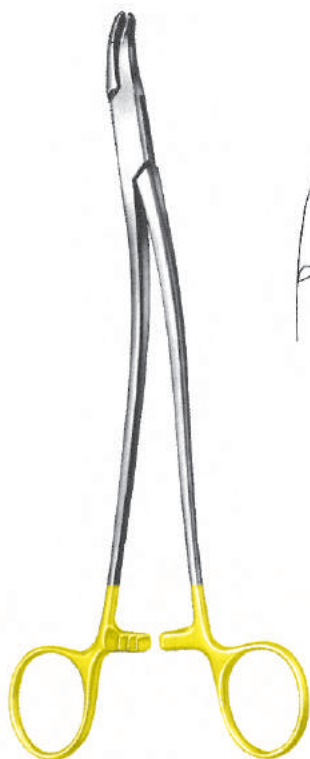

Stratte

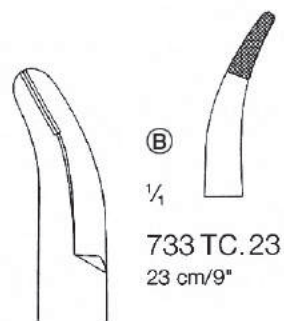
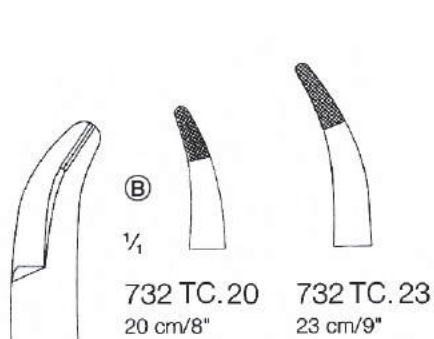

Stratte reverse

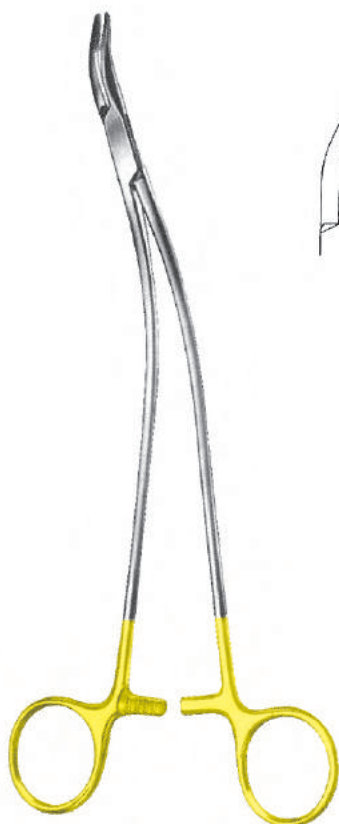



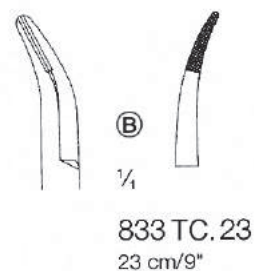
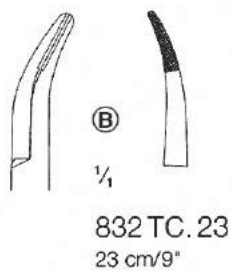

Stratte Delicate

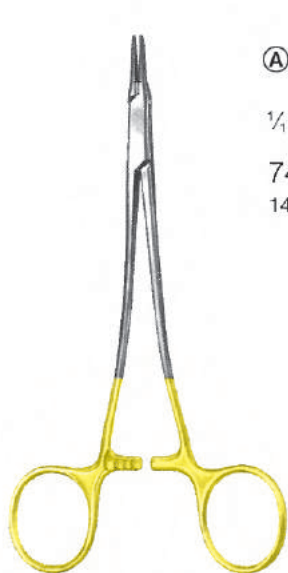

Stratte Delicate reverse



Eufrate-Pasqué

<p>Ⓐ</p> <p>¼</p> 			
<p>748 TC.14</p> <p>14 cm/5 ½"</p>	<p>748 TC.15</p> <p>15 cm/6"</p>	<p>748 TC.18</p> <p>18 cm/7"</p>	<p>748 TC.20</p> <p>20 cm/8"</p>



Eufrate-Pasqué

<p>Ⓓ</p> <p>¼</p> 			
<p>749 TC.14</p> <p>14 cm/5 ½"</p>	<p>749 TC.15</p> <p>15 cm/6"</p>	<p>749 TC.18</p> <p>18 cm/7"</p>	<p>749 TC.20</p> <p>20 cm/8"</p>



















1/2

Micro
 Ø 8 mm
 14 cm/5 1/2"
 15 cm/6"

with spring catch		1,2 mm	1,5 mm	1,8 mm	2,5 mm	1,2 mm	1,5 mm	1,8 mm	2,5 mm
(D) 14 cm/5 1/2" 15 cm/6*	614	TC. 12				614	TC. 32		
	615	TC. 12	615 TC. 15	615 TC. 18	615 TC. 25	615 TC. 32	615 TC. 35	615 TC. 38	615 TC. 45
(A) 1/1 14 cm/5 1/2" 15 cm/6*	614	TC. 52				614	TC. 72		
	615	TC. 52	615 TC. 55	615 TC. 58	615 TC. 65	615 TC. 72	615 TC. 75	615 TC. 78	615 TC. 85



with spring catch



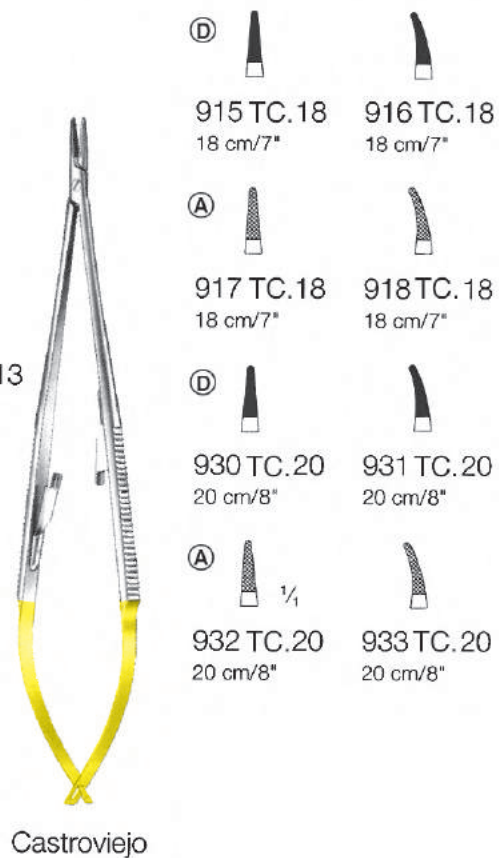
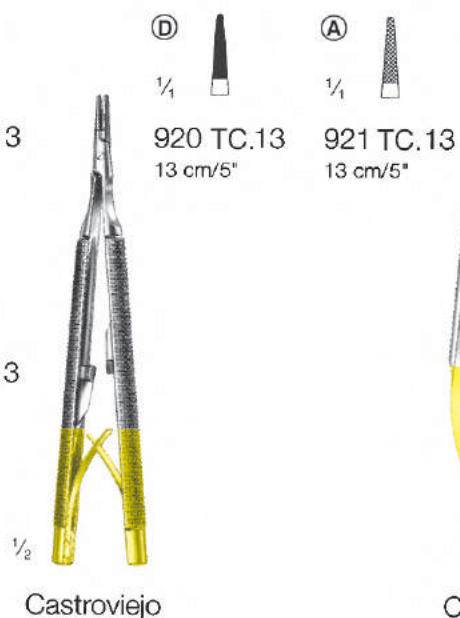
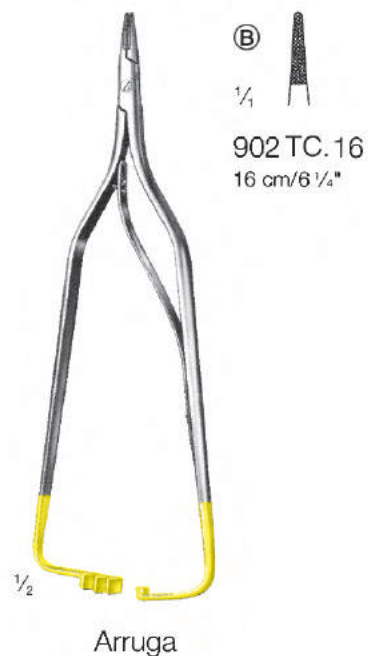
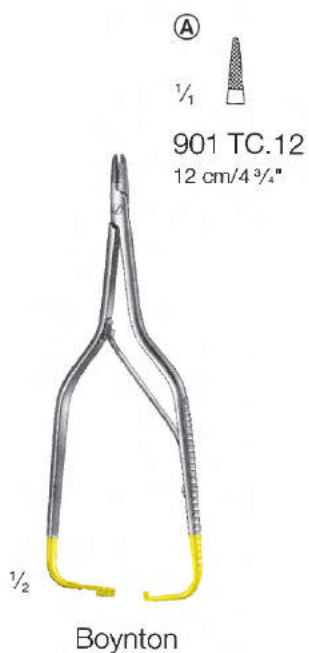
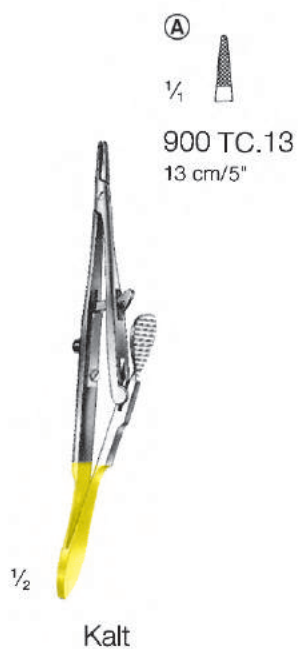

	1,2 mm	1,5 mm	1,8 mm	2,5 mm	1,2 mm	1,5 mm	1,8 mm	2,5 mm	
D 1/1									
18 cm/7"	618 TC. 12	618 TC. 15	618 TC. 18	618 TC. 25	618 TC. 32	618 TC. 35	618 TC. 38	618 TC. 45	
21 cm/8 1/4"	621 TC. 12		621 TC. 18		621 TC. 32		621 TC. 38		
23 cm/9"	623 TC. 12		623 TC. 18		623 TC. 32		623 TC. 38		
A 1/1									
18 cm/7"	618 TC. 52	618 TC. 55	618 TC. 58	618 TC. 65	618 TC. 72	618 TC. 75	618 TC. 78	618 TC. 85	618 TC. 92
21 cm/8 1/4"	621 TC. 52		621 TC. 58		621 TC. 72		621 TC. 78		
23 cm/9"	623 TC. 52		623 TC. 58		623 TC. 72		623 TC. 78		

Micro
 Ø 9 mm
 18 cm/7"
 21 cm/8 1/4"
 23 cm/9"





Mayo-Castroviejo

	1,2 mm			
				
16 cm/6 1/4"	940 TC.16	950 TC.16	945 TC.16	955 TC.16
18 cm/7"	941 TC.18	951 TC.18	946 TC.18	956 TC.18
20 cm/8"	942 TC.20	952 TC.20	947 TC.20	957 TC.20
23 cm/9"	943 TC.23	953 TC.23	948 TC.23	958 TC.23
26 cm/10 1/4"	944 TC.26	954 TC.26	949 TC.26	959 TC.26

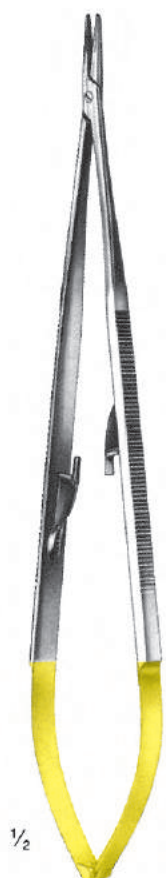

 791 TC.24
 24 cm/9 1/2"

Giannini

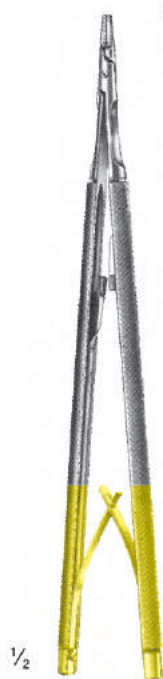



 970 TC.18
 18 cm/7"

Hepp-Scheidel

 971 TC.18
 18 cm/7"





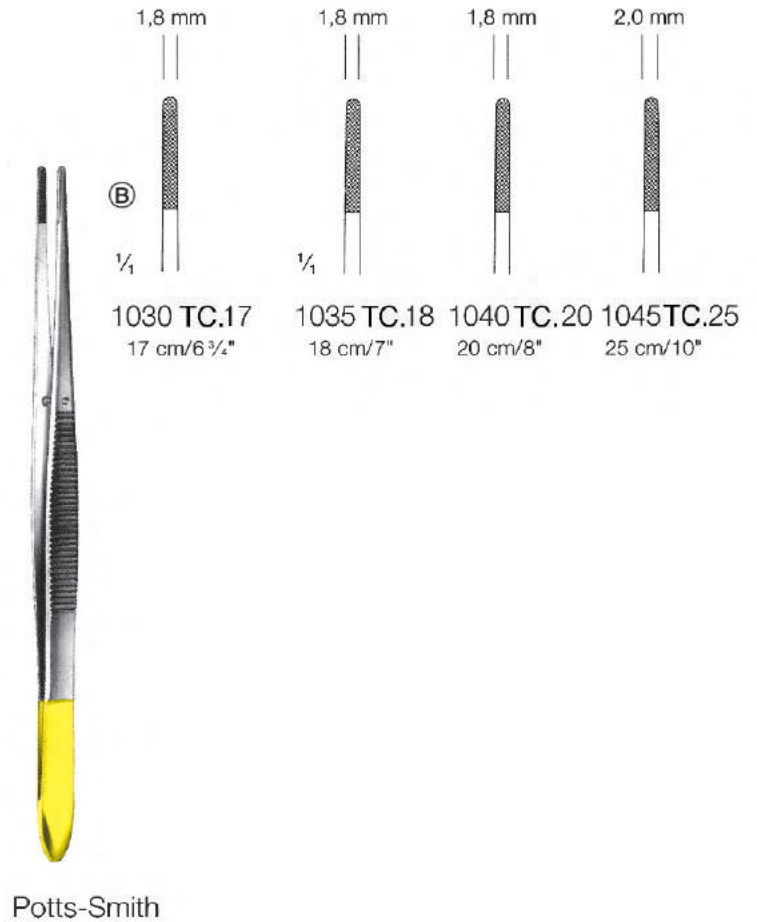
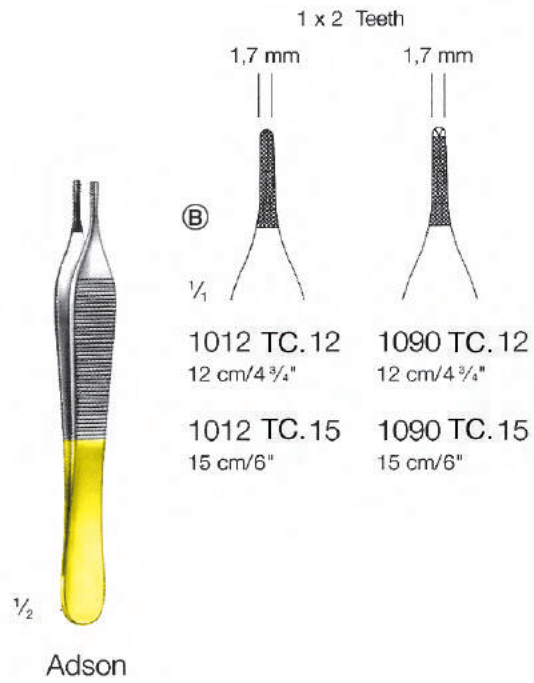
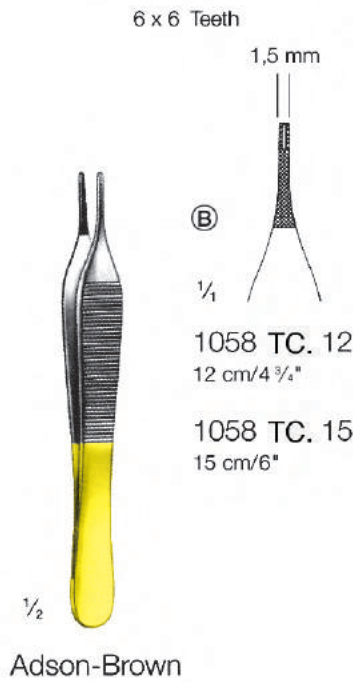

 793 TC.18
 18 cm/7"

Parell



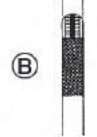
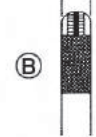

	2,0 mm	2,7 mm	3,5 mm		1,5 mm
	 ② $\frac{1}{4}$	 ②	 ②		 ② $\frac{1}{4}$
	1200 TC.15 15 cm/6"	1205 TC.15 15 cm/6"			1215 TC.15 15 cm/6"
	1201 TC.20 20 cm/8"	1206 TC.20 20 cm/8"	1210 TC.20 20 cm/8"		1216 TC.20 20 cm/8"
1202 TC.24 24 cm/9 1/2"	1207 TC.24 24 cm/9 1/2"	1211 TC.24 24 cm/9 1/2"		1217 TC.24 24 cm/9 1/2"	
DeBakey				DeBakey	

Wire Cutting Pliers

Pinces fil de coupe

Alicates de corte de alambre

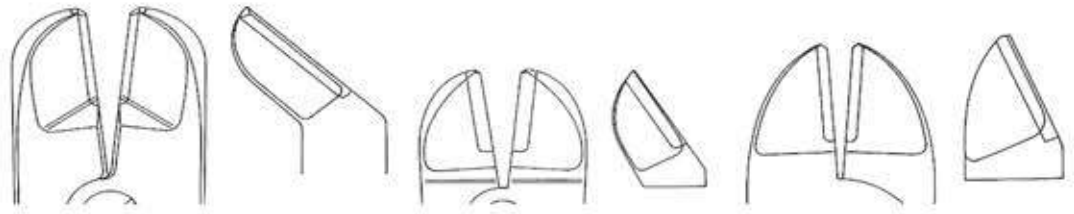

for soft wire up to \varnothing 3.0 mm
for hard wire up to \varnothing 2.5 mm

Müller-Claus
22 cm/8.75"
8-800TC.22



2.0 mm
1.6 mm

Müller-Claus
8-810TC.16 16 cm/6.25"
8-810TC.18 18 cm/7"



2.0 mm
1.6 mm

Reill
17.5 cm/6.75"
8-812TC.18

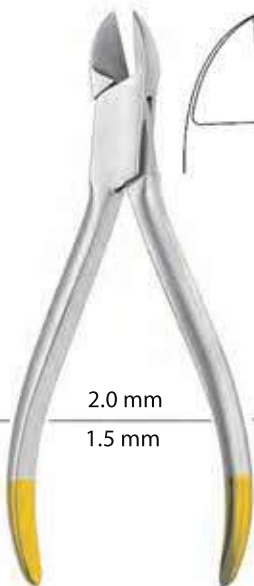

for soft wire up to \varnothing 2.0 mm
for hard wire up to \varnothing 1.5 mm

14 cm/5.5"
8-815TC.14

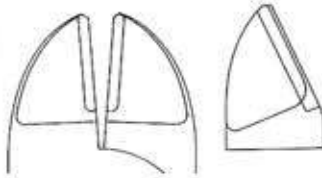

2.0 mm
1.5 mm

20 cm/8"
8-815TC.20

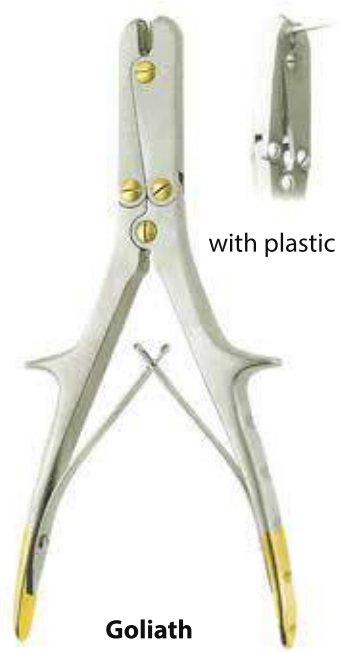

with plastic insert



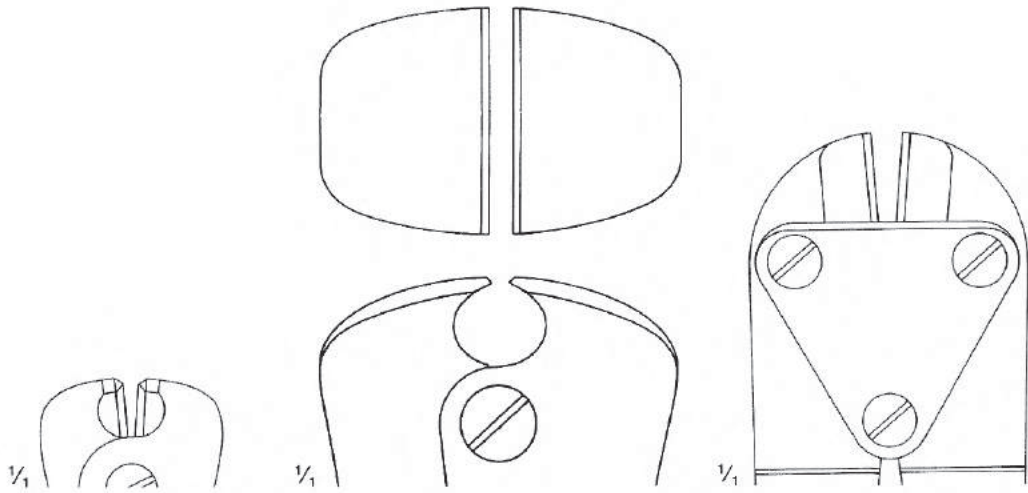

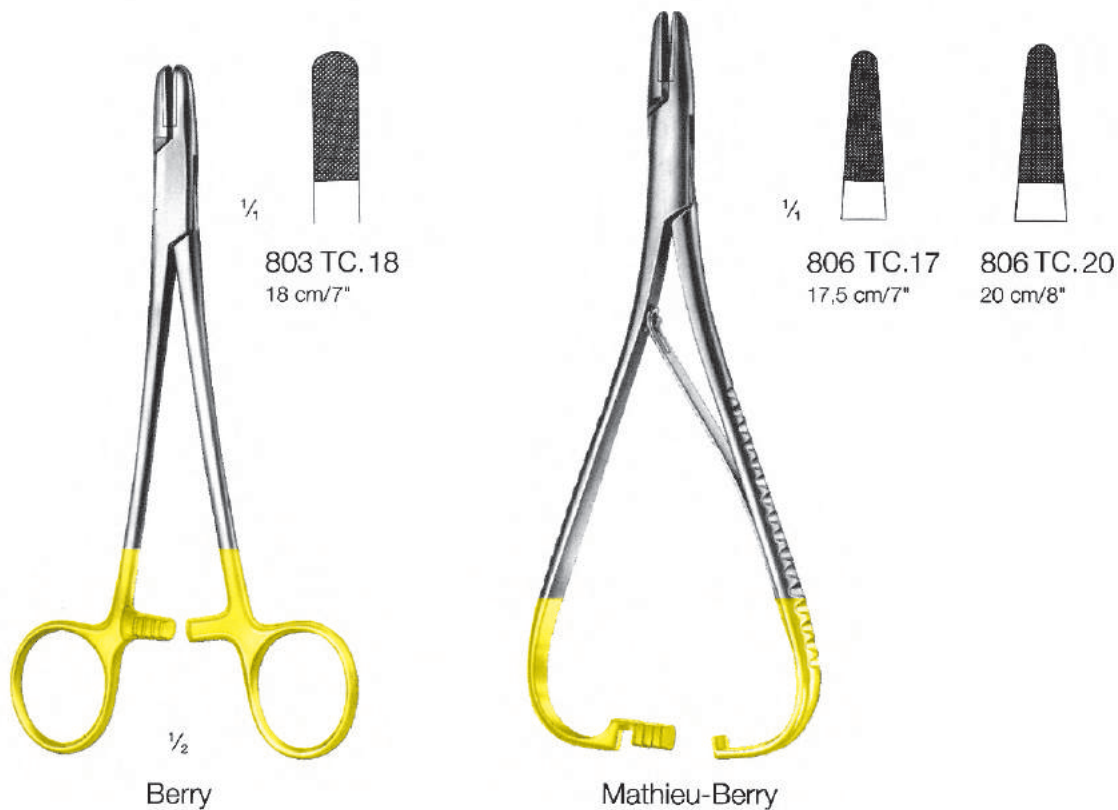
Goliath
25 cm/10"
8-818TC.25









Mayo-Hauberisser

ⓑ					
1/4					
796 TC.16	797 TC.16	798 TC.16	797 TC.18	798 TC.18	
16 cm/6 1/4"	16 cm/6 1/4"	16 cm/6 1/4"	18 cm/7"	18 cm/7"	





Mayo-Hauberisser

ⓑ		
1/4		
795 TC.17	795 TC.20	
17 cm/6 3/4"	20 cm/8"	



Corwin-Hegar

ⓑ			
1/4			
800 TC.16	801 TC.16	802 TC.16	
16 cm/6 1/4"	16 cm/6 1/4"	16 cm/6 1/4"	

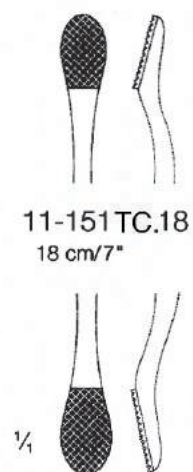
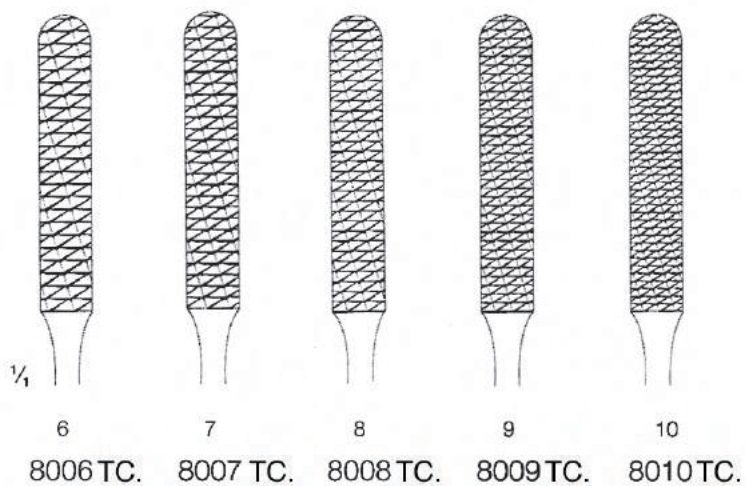
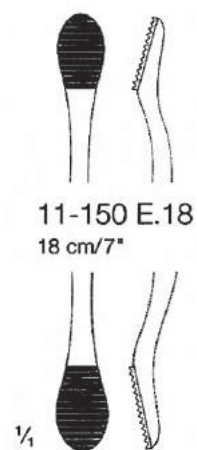
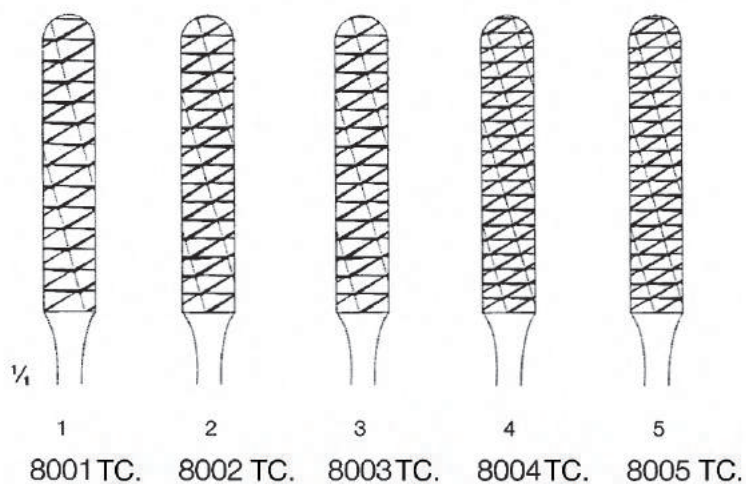

Maltz
18 cm/7"



Miller

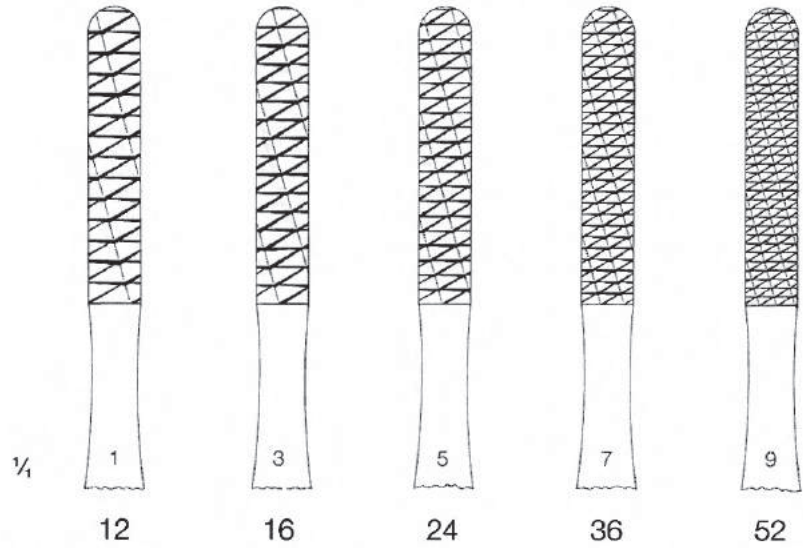

teeth per inch

14 20 30 44 62

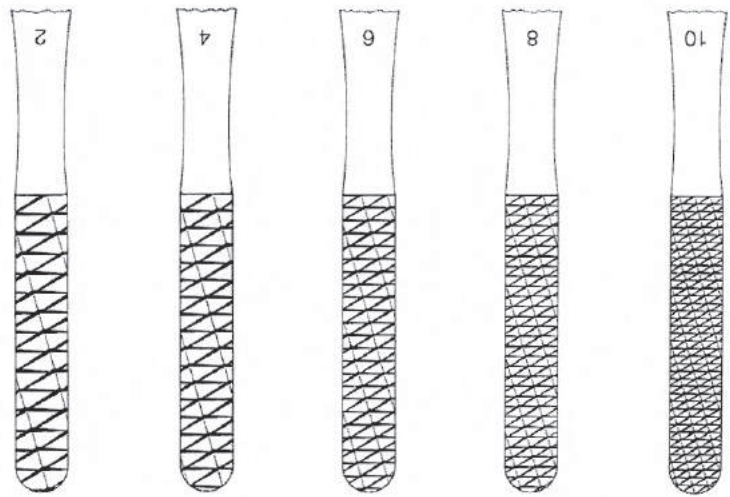

8012 TC. 8034 TC. 8056 TC. 8078 TC. 8091TC.



Fomon
20 cm/8"

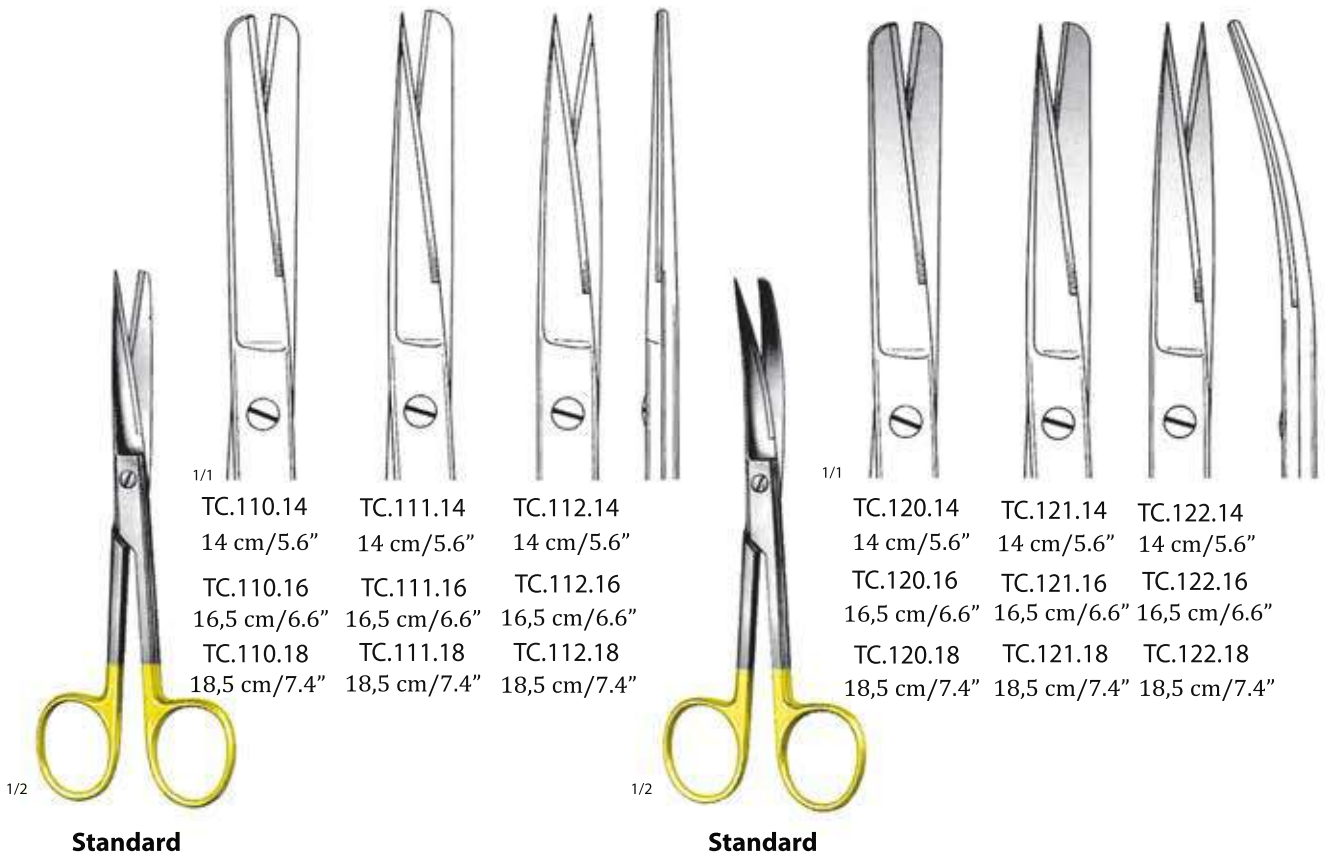



Mayo

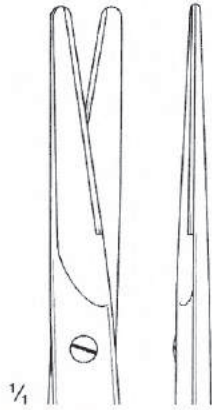

TC.130.14
14 cm/5 1/2"

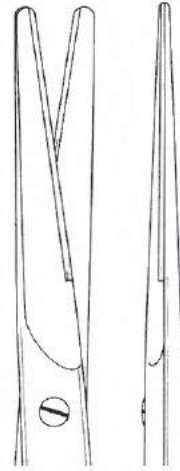

TC.130.17
17 cm/6 3/4"

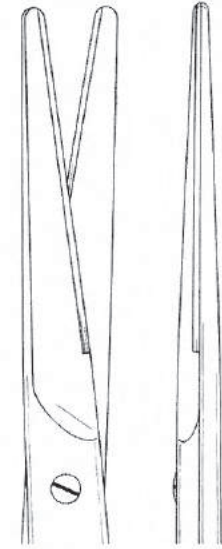

TC.160.23
23 cm/9"



Mayo

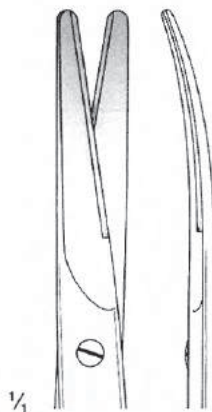

TC.131.14
14 cm/5 1/2"

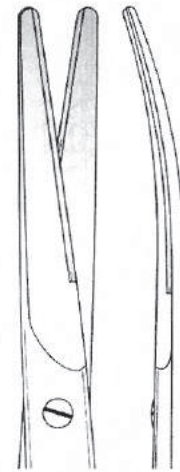

TC.131.17
17 cm/6 3/4"

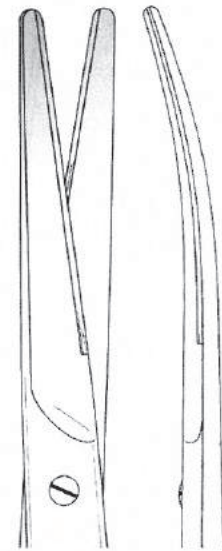

TC.161.23
23 cm/9"

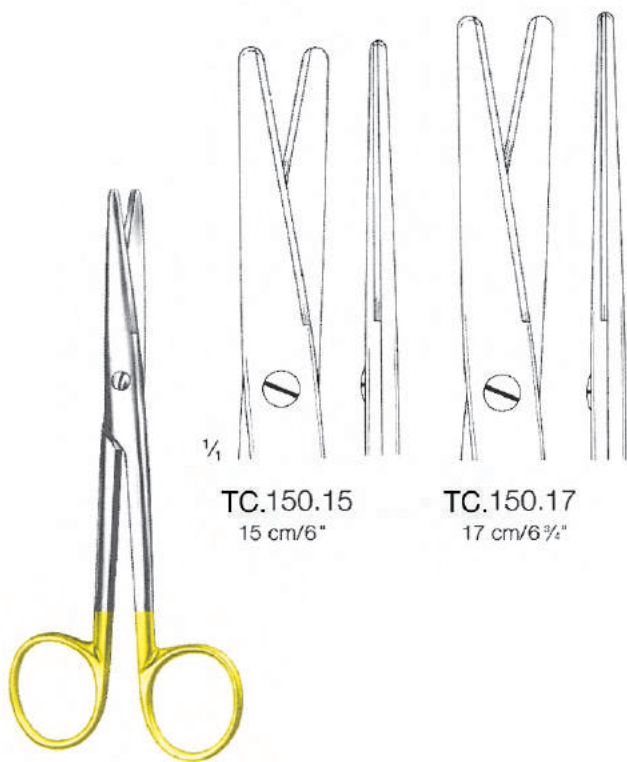

TC.150.15
15 cm/6"

TC.150.17
17 cm/6 3/4"

Mayo-Stille

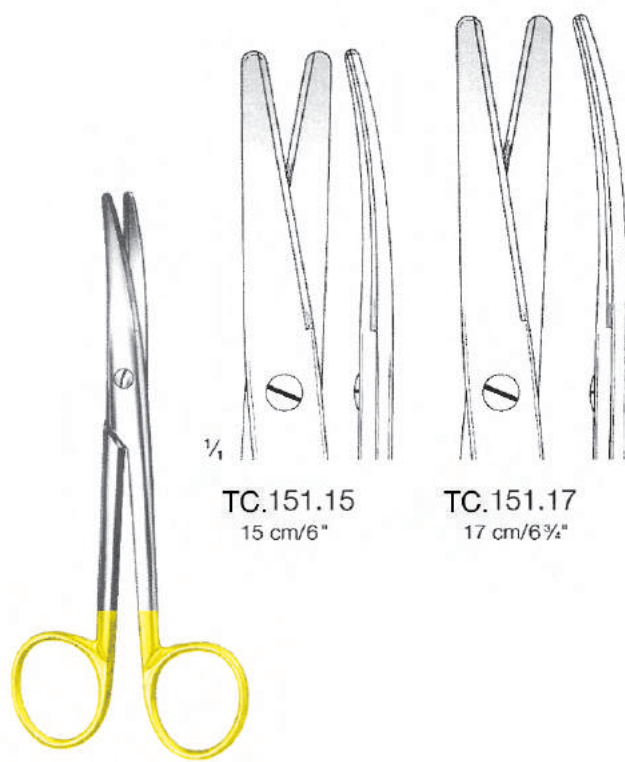

TC.151.15
15 cm/6"

TC.151.17
17 cm/6 3/4"

Mayo-Stille

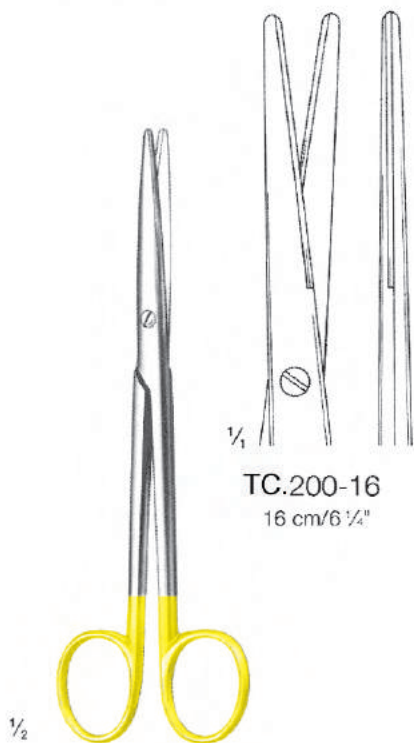

TC.200-16
16 cm/6 1/4"

1/2

Mayo-Lexer

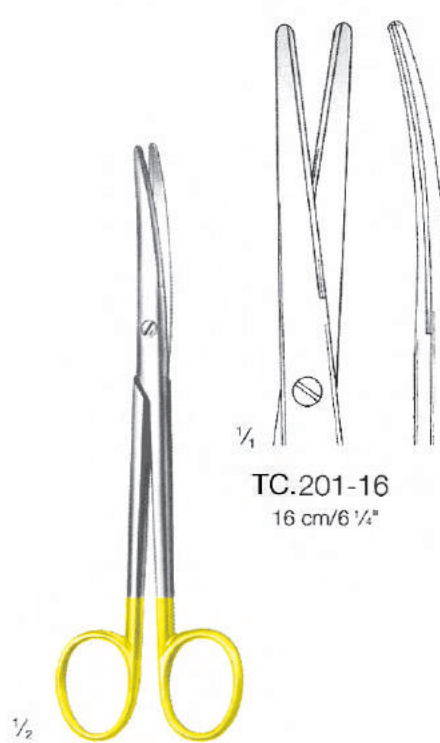

TC.201-16
16 cm/6 1/4"

1/2

Mayo-Lexer

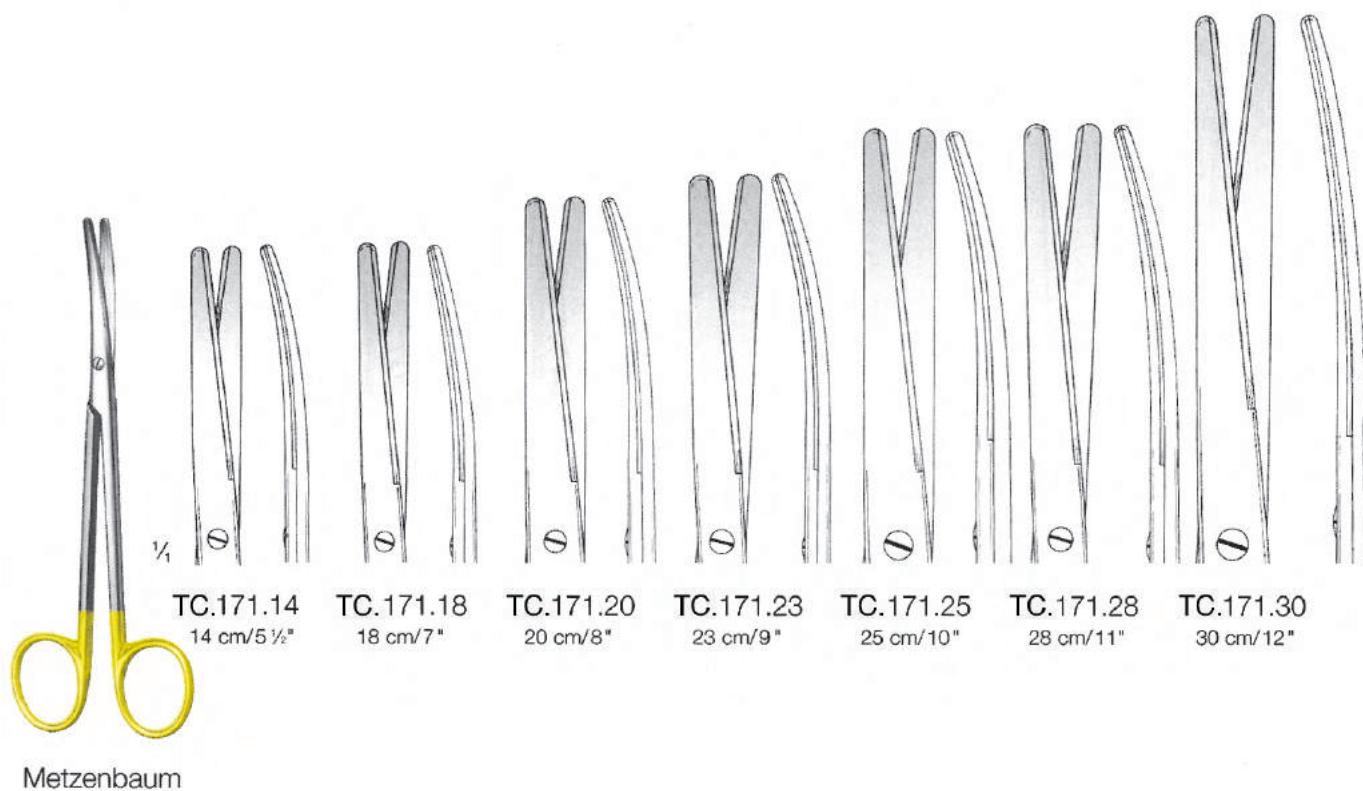
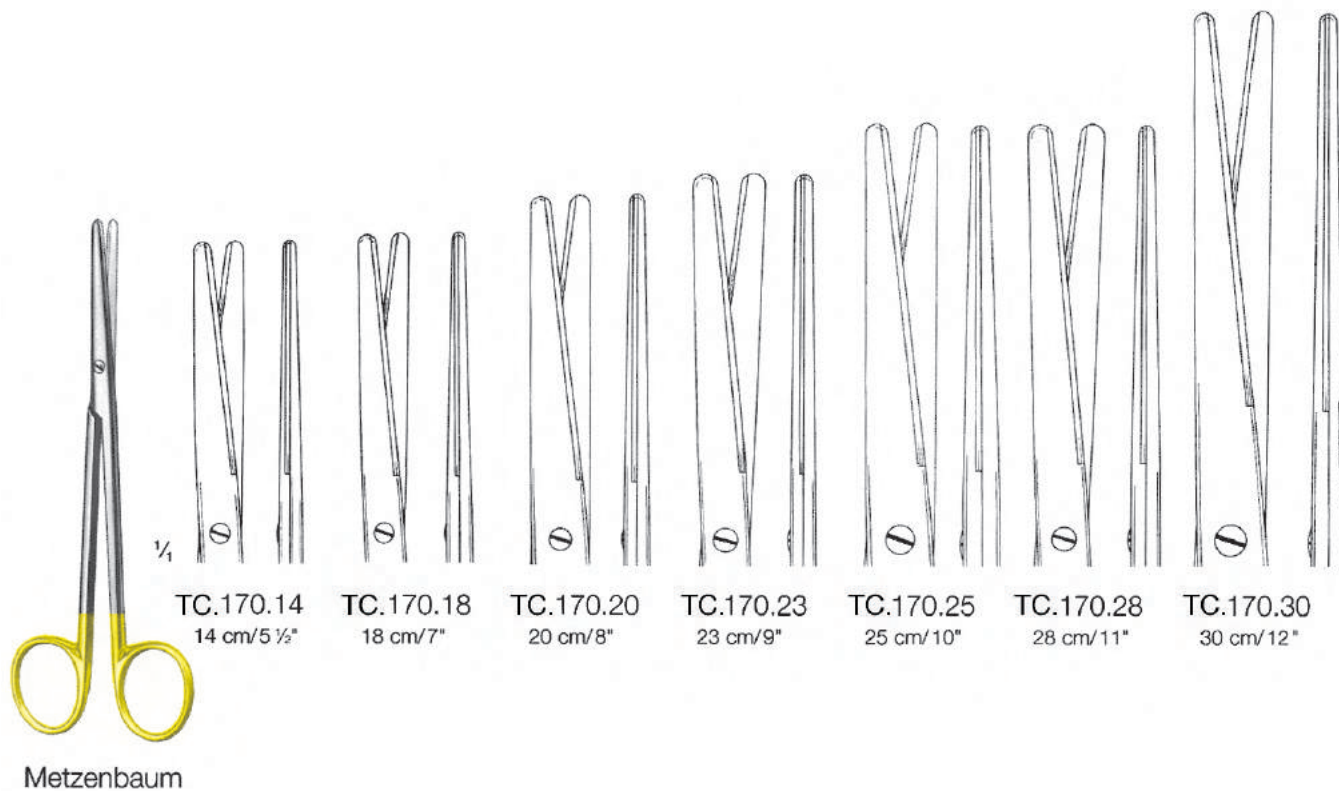

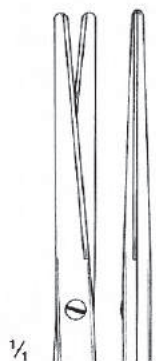

TC.190.14
14 cm/5 1/2"

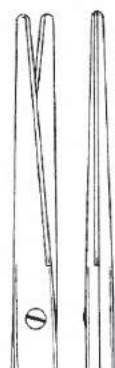

TC.190.18
18 cm/7"



TC.190.20
20 cm/8"

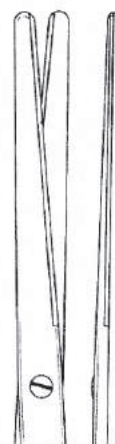

TC.190.23
23 cm/9"

Metzenbaum-Fino

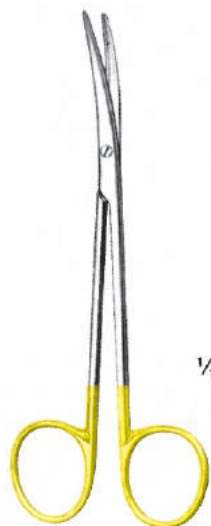

TC.191.14
14 cm/5 1/2"



TC.191.18
18 cm/7"



TC.191.20
20 cm/8"

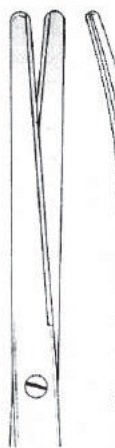

TC.191.23
23 cm/9"

Metzenbaum-Fino

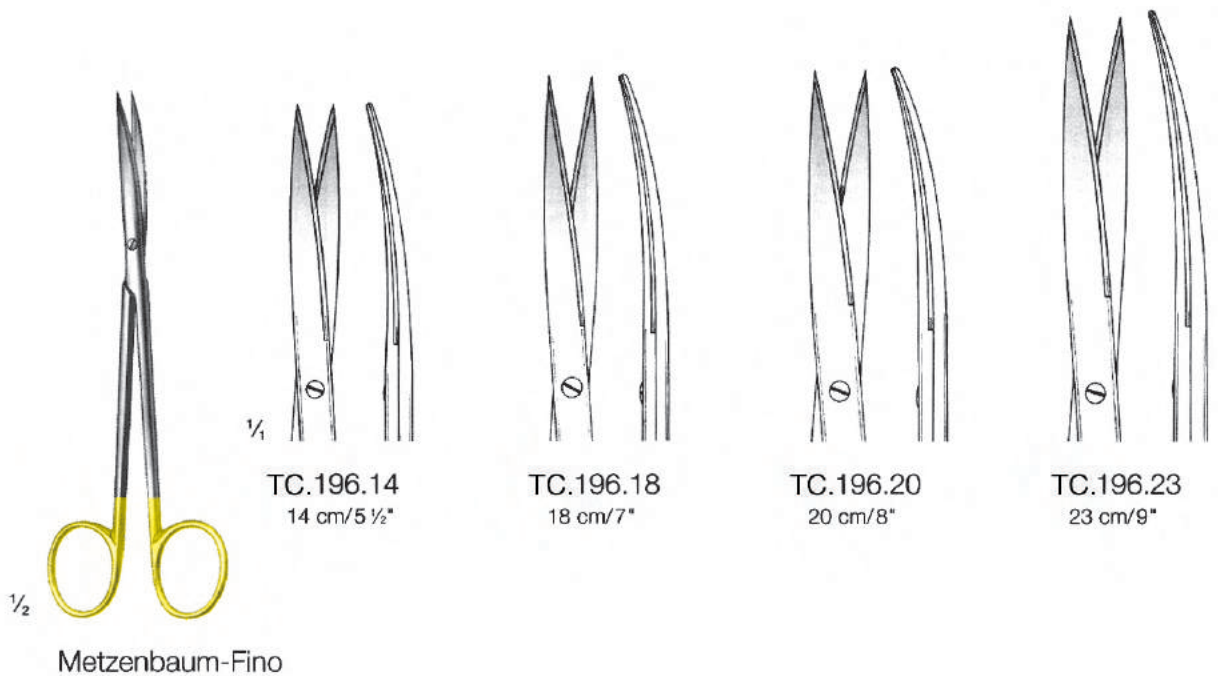
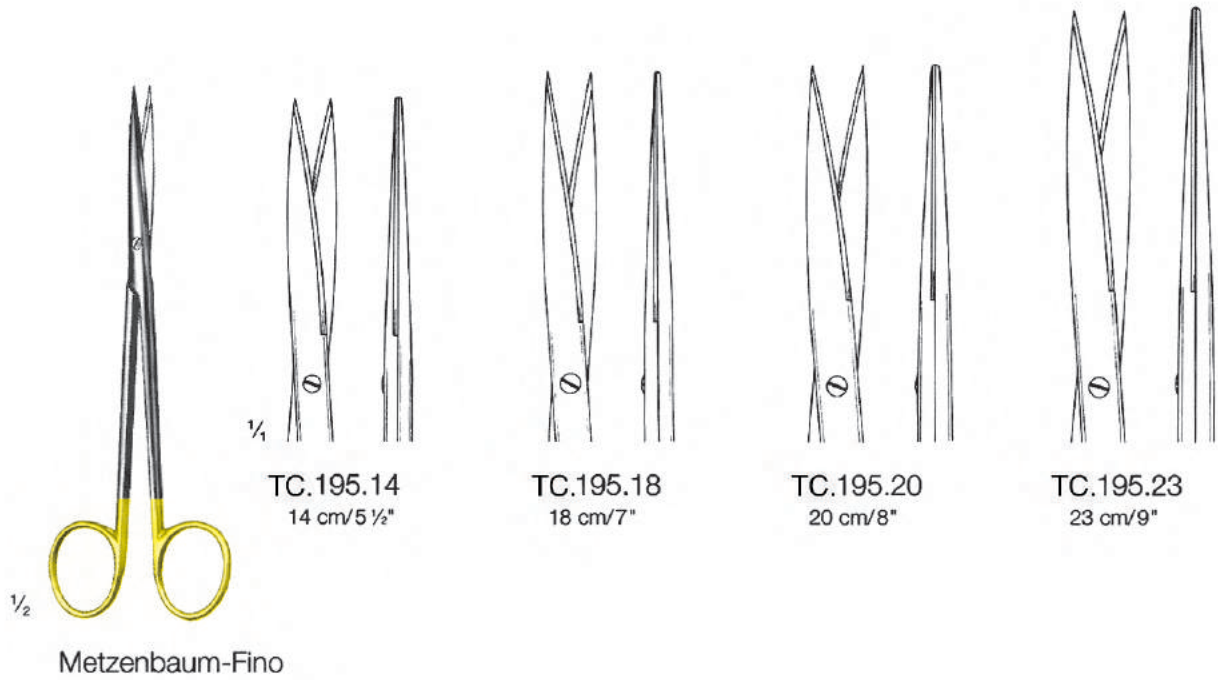

Ligature Scissors

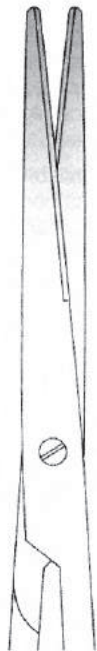

1 Blade serrated



TC.9155.14 14,5 cm/5 3/4" TC.9155.18 18 cm/7" TC.9155.20 20 cm/8" TC.9155.23 23 cm/9" 02-9155.25 25 cm/10"

Parametrium Scissors

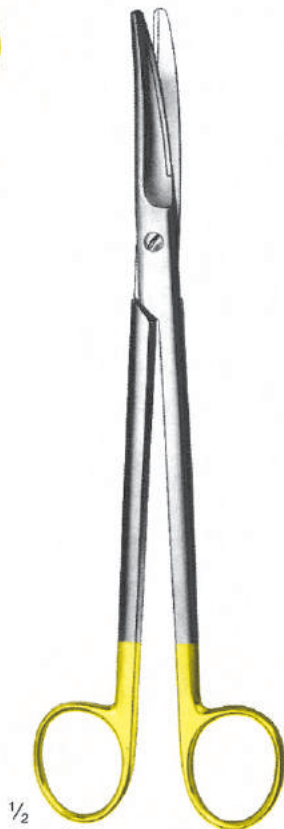

light curve

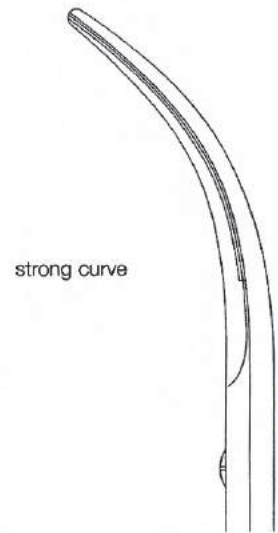

TC.9411.23
23 cm/9"

TC.9413.22
22 cm/8 3/4"

Parametrium

Fine scissors, wire cutting scissors
Ciseaux fins, Ciseaux coupe fils
Tijeras finas, Cizellas para cortar alambre

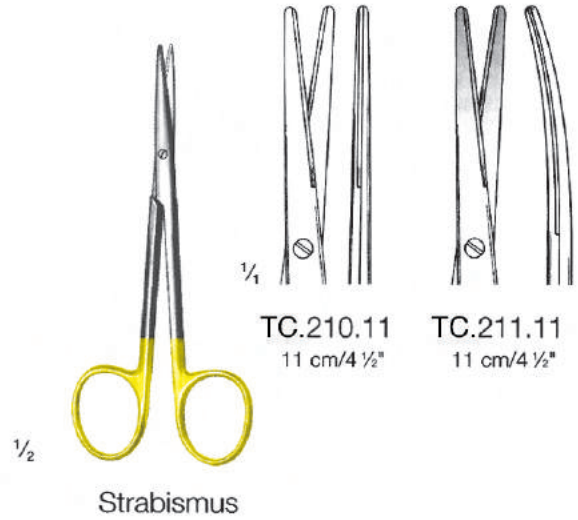
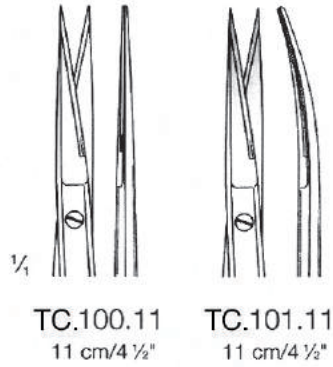

for soft wire up to mm Ø	1,0 mm	1,0 mm
for hard wire up to Ø	0,6 mm	0,6 mm

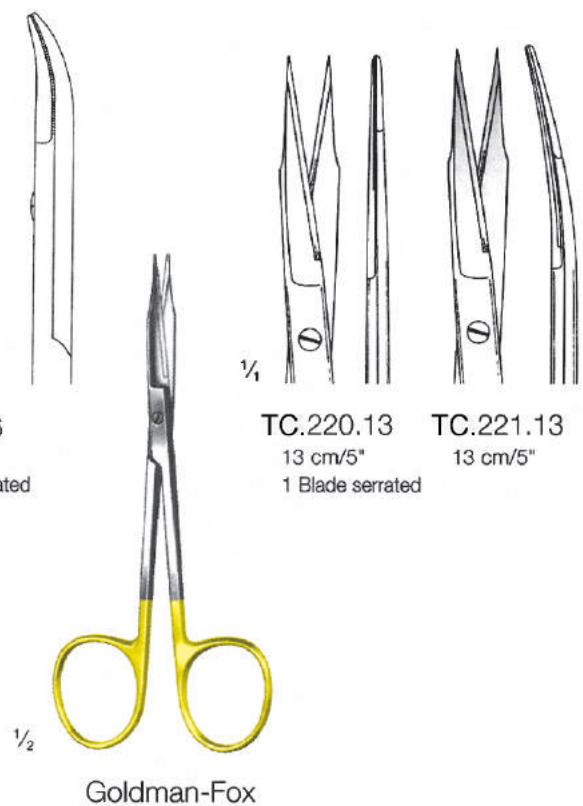
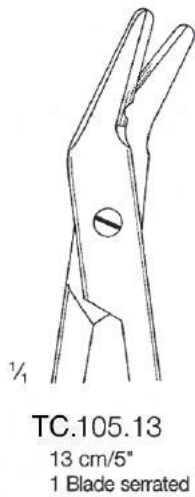

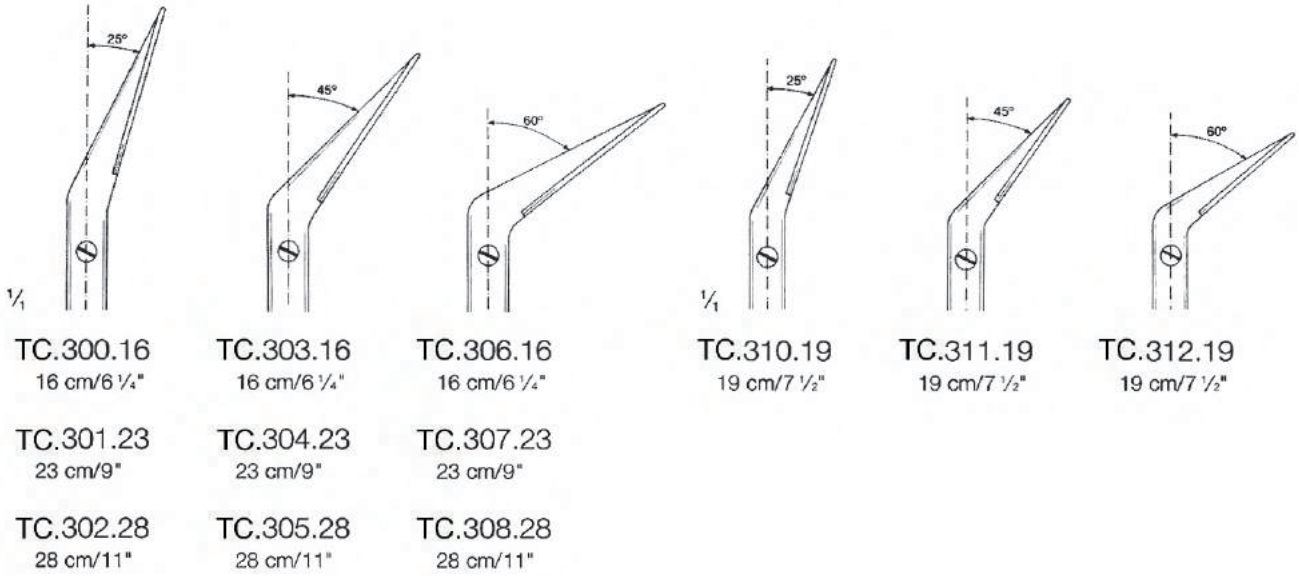

DeBakey

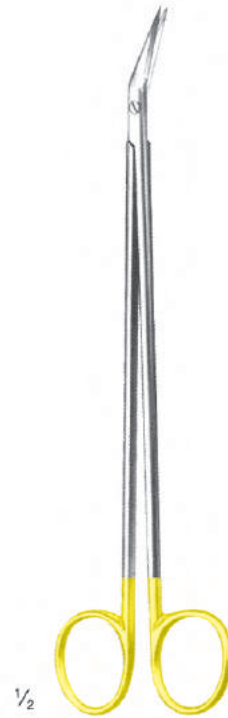

$\frac{1}{2}$

Potts-Smith

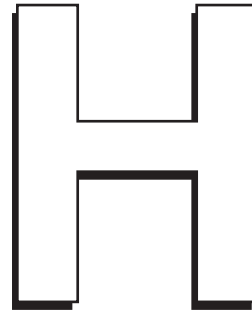

- Gynecology, obstetrics
- Gynécologie, obstétrique
- Ginecología, obstetricia

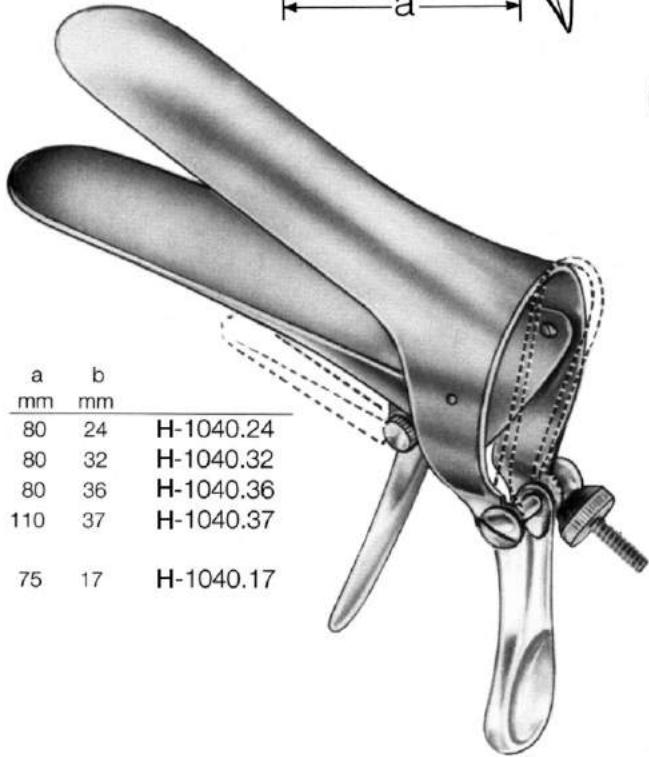
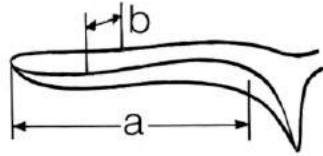

a mm	b mm	
80	24	H-1040.24
80	32	H-1040.32
80	36	H-1040.36
110	37	H-1040.37
75	17	H-1040.17

Cusco

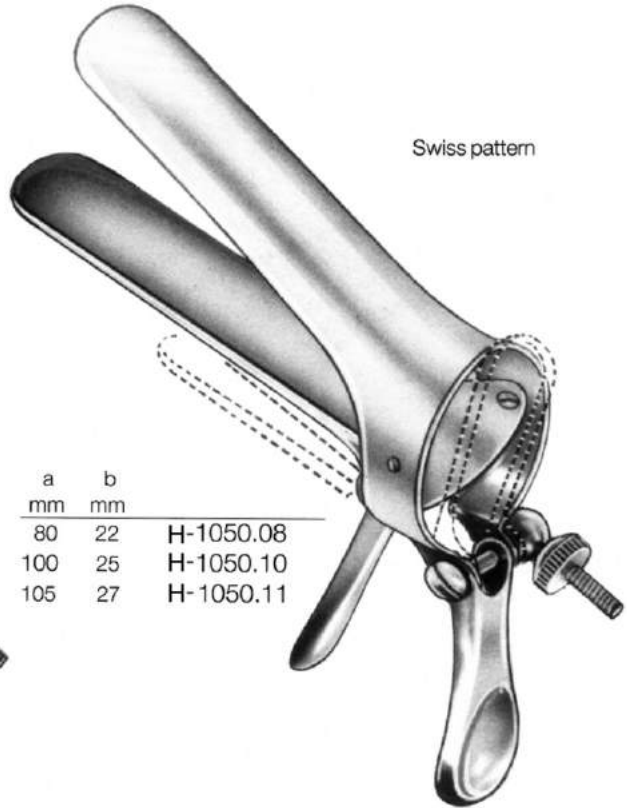

Swiss pattern

a mm	b mm	
80	22	H-1050.08
100	25	H-1050.10
105	27	H-1050.11

Cusco

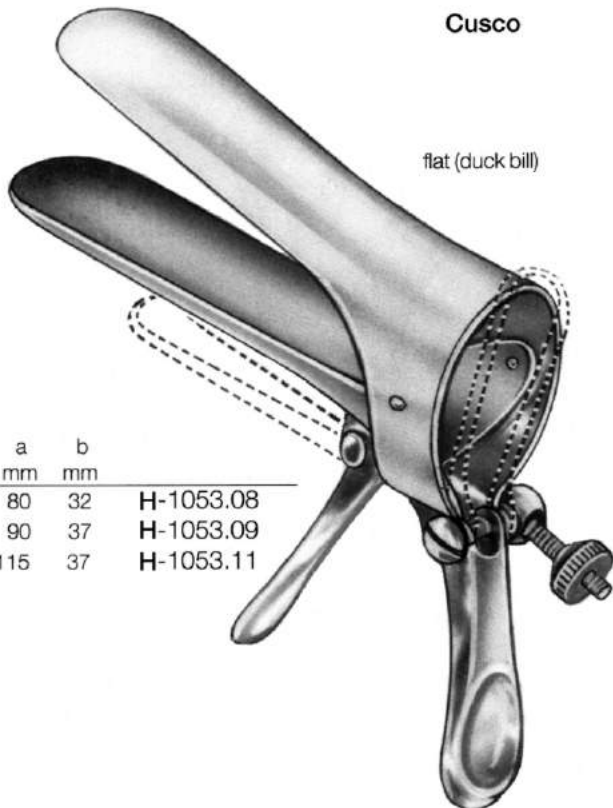

flat (duck bill)

a mm	b mm	
80	32	H-1053.08
90	37	H-1053.09
115	37	H-1053.11

Cusco

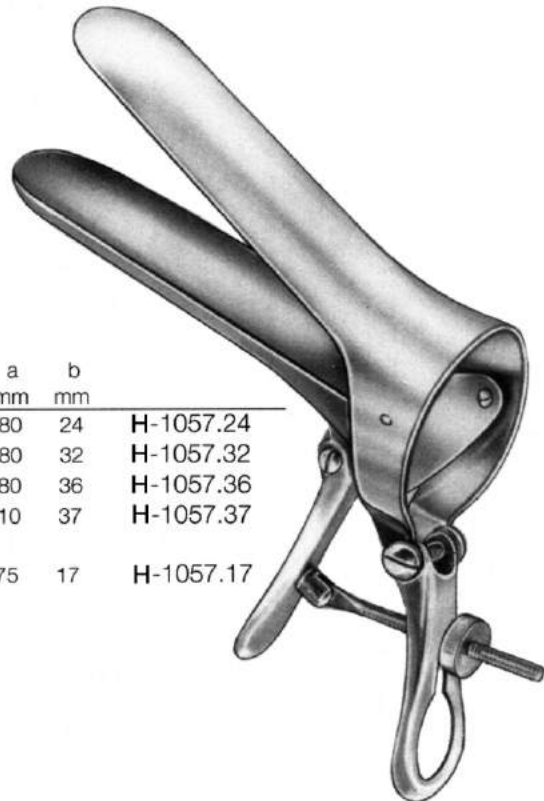

Cusco

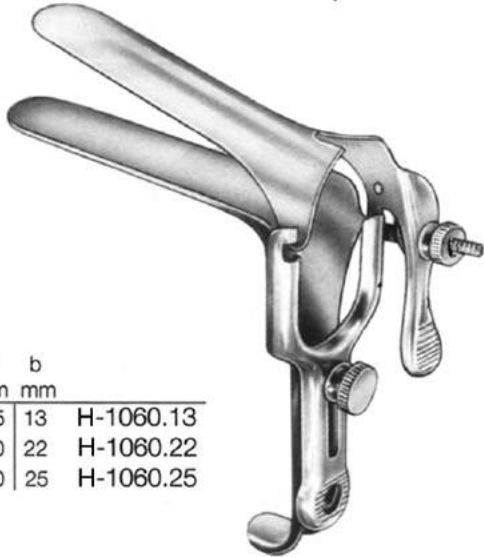
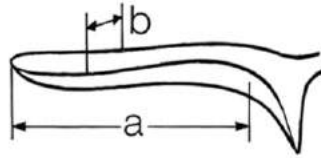

a	b	
mm	mm	
75	13	H-1060.13
100	22	H-1060.22
120	25	H-1060.25

Pederson

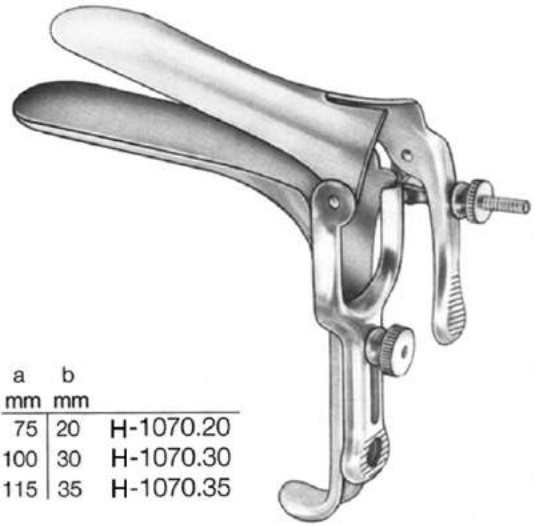

a	b	
mm	mm	
75	20	H-1070.20
100	30	H-1070.30
115	35	H-1070.35

Graves

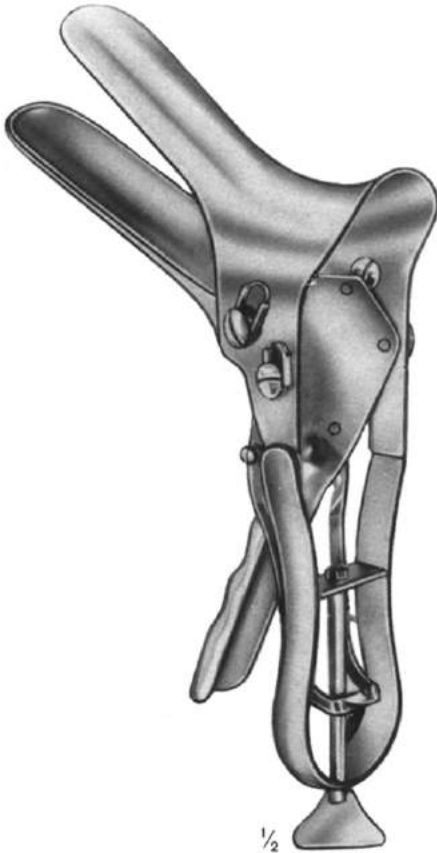

1/2

Seyffert
H-1090.17 100 x 17 mm
H-1090.33 110 x 33 mm

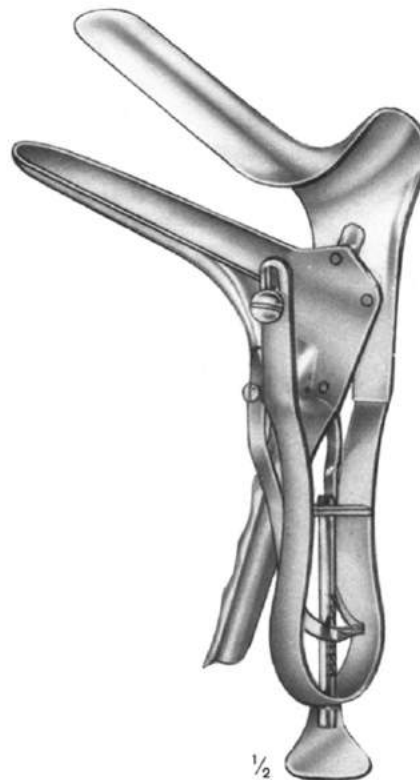

1/2

Seyffert
H-1091.33 110 x 33 mm

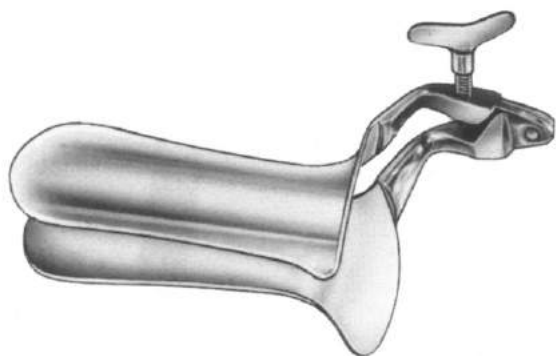
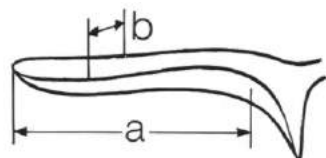

Collin

a	b	
mm	mm	
90	30	H-1109.30
95	35	H-1109.35
105	40	H-1110.40

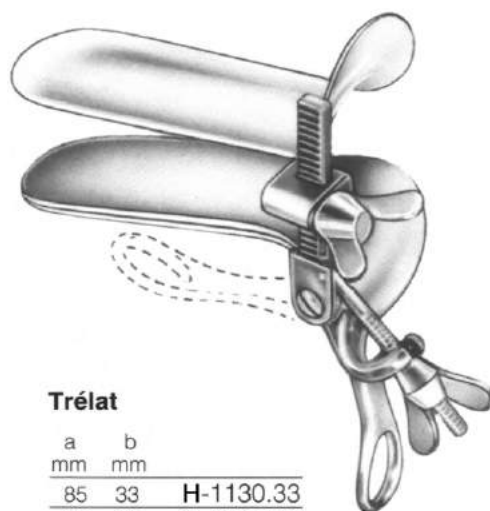

Trélat

a	b	
mm	mm	
85	33	H-1130.33
95	35	H-1130.35
115	43	H-1130.43

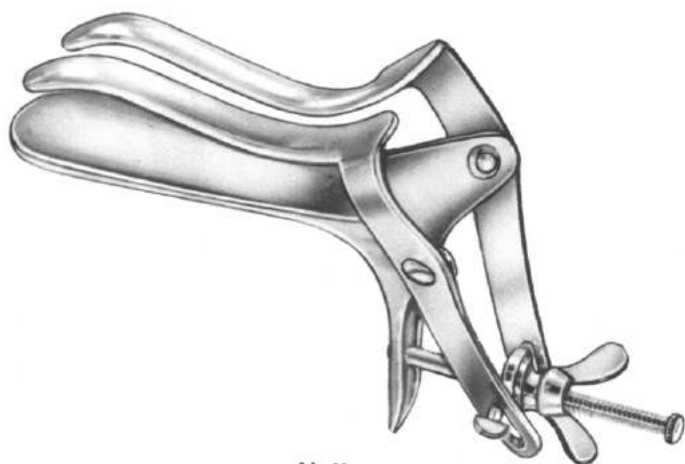

Nott

a	b	
mm	mm	
90	27	H-1140.27 C
100	30	H-1140.30 C

chrome plated



Semm

a	b	
mm	mm	
100	17/20	H-1180.17
100	25/30	H-1180.25

a	b	
mm	mm	
90	14/18	H-1180.14

for children and virgins



½ Kristeller



½ Kristeller

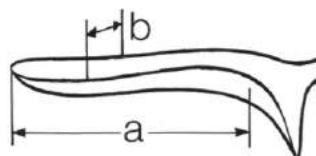

½ Kristeller

		Specula	
		a	b
Fig. 1	H-1400.27	70 x 27 mm	
Fig. 2	H-1400.30	75 x 30 mm	
Fig. 3	H-1400.36	90 x 36 mm	

		Retractors	
		a	b
Fig. 1	H-1401.23	75 x 23 mm	
Fig. 2	H-1401.26	80 x 26 mm	
Fig. 3	H-1401.32	95 x 32 mm	

		Set of 1 Speculum and 1 Retractor ea.	
Fig. 1	H-1402.27		
Fig. 2	H-1402.30		
Fig. 3	H-1402.36		



½ Kristeller



½ Kristeller



½ Kristeller

		Specula	
		a	b
Fig. 00	H-1405.18	110 x 18 mm	
Fig. 0	H-1405.21	110 x 21 mm	
Fig. 1	H-1405.27	110 x 27 mm	
Fig. 2	H-1405.30	110 x 30 mm	
Fig. 3	H-1405.36	110 x 36 mm	

		Retractors	
		a	b
Fig. 00	H-1406.14	115 x 14 mm	
Fig. 0	H-1406.17	115 x 17 mm	
Fig. 1	H-1406.23	115 x 23 mm	
Fig. 2	H-1406.26	115 x 26 mm	
Fig. 3	H-1406.32	115 x 32 mm	

		Set of 1 Speculum and 1 Retractor ea.	
Fig. 00	H-1407.18		
Fig. 0	H-1407.21		
Fig. 1	H-1407.27		
Fig. 2	H-1407.30		
Fig. 3	H-1407.36		

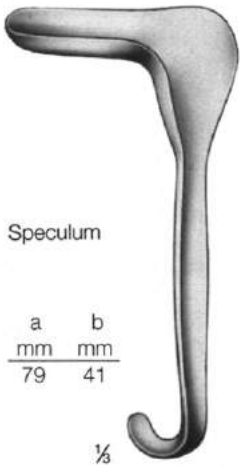

Speculum

a	b
mm	mm
79	41

1/8

Kallmorgen
H-1450.41

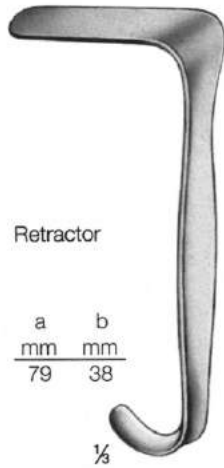

Retractor

a	b
mm	mm
79	38

1/8

Kallmorgen
H-1451.38

Kallmorgen
H-1452.41

Set

Fig.	a	b	
	mm	mm	
1	70	27	H-1480.01
2	75	30	H-1480.02
3	90	36	H-1480.03

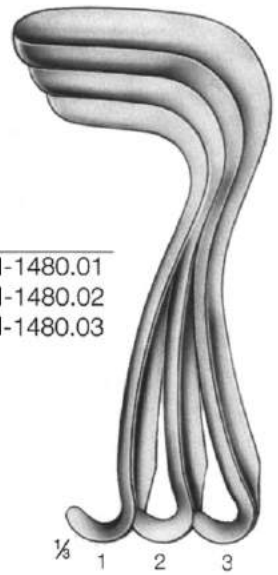

1/8 1 2 3

Sims
18,5 cm / 7 1/4"

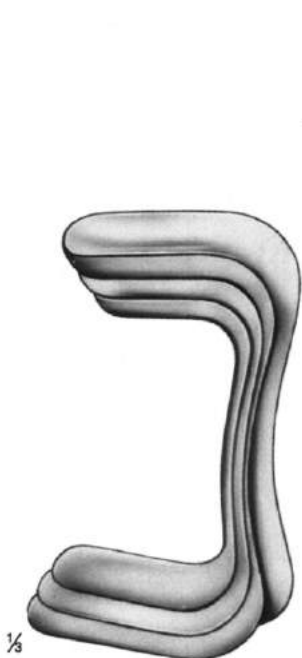
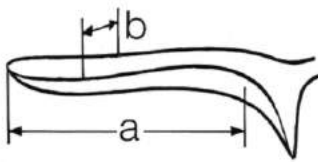

Sims

Fig.	a	b	
	mm	mm	
1	60	25+30	H-1490.01
2	70	30+35	H-1490.02
3	80	35+40	H-1490.03
		set	H-1490.00



1/8

Auvard
a b
mm mm
75 40
H-1580.11



1/8

Auvard
a b kg lbs
mm mm
83 38 1,14 2,5
H-1582.11



1/8

Weissbarth
21 cm 8 1/4"

a	b
mm	mm
80	42

H-1590.21

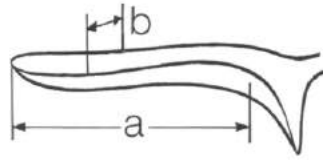

$\frac{1}{2}$
Breisky
29 cm/11 $\frac{1}{4}$ "



$\frac{1}{2}$
Breisky
32 cm/12 $\frac{1}{2}$ "



$\frac{1}{2}$
Breisky
35 cm/13 $\frac{3}{4}$ "



$\frac{1}{2}$
Breisky
37 cm/14 $\frac{1}{4}$ "

	a	b		a	b		a	b		a	b
H-1710.20	100	20	H-1713.20	130	20	H-1716.20	160	20	H-1718.20	180	20
H-1710.25	100	25	H-1713.25	130	25	H-1716.25	160	25	H-1718.25	180	25
H-1710.30	100	30	H-1713.30	130	30	H-1716.30	160	30	H-1718.30	180	30
H-1710.35	100	35	H-1713.35	130	35	H-1716.35	160	35	H-1718.35	180	35
H-1710.40	100	40	H-1713.40	130	40	H-1716.40	160	40	H-1718.40	180	40

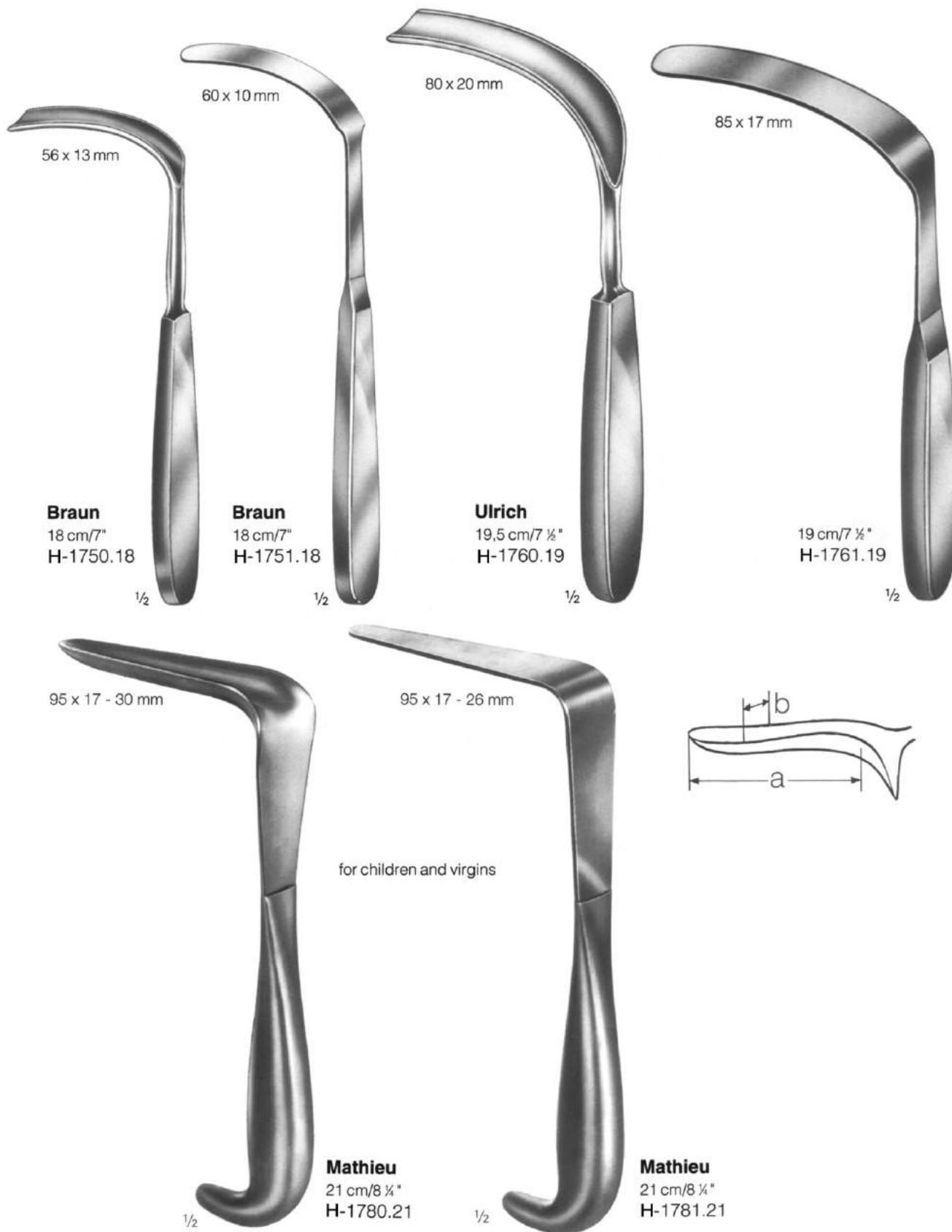

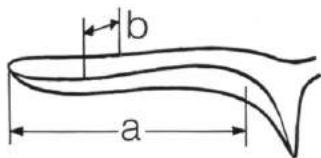

1/2

Landau
30 cm/12"

	a	b
H-1783.28	100 x 28 mm	
H-1783.38	110 x 38 mm	

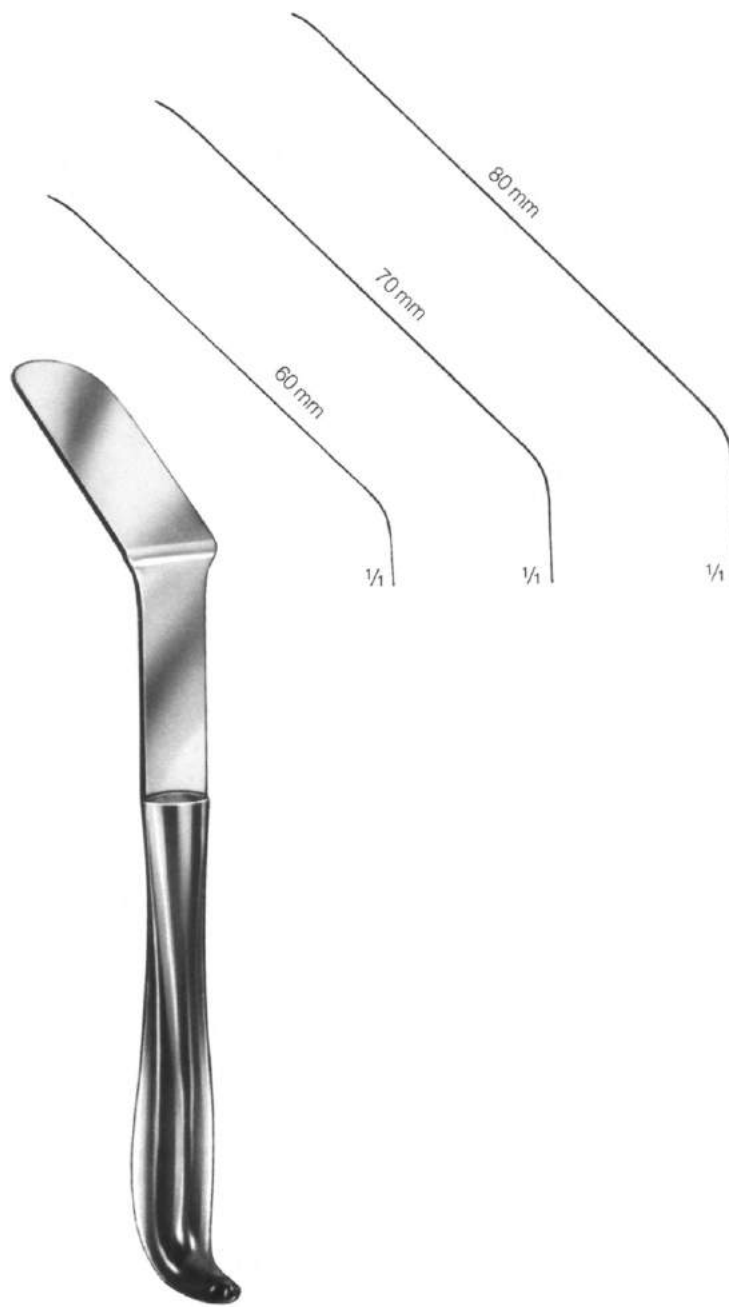

Doyen

	cm	in.	a	b
H-1793.63	23	9	60 x 30 mm	
H-1793.73	24	9 1/2	70 x 30 mm	
H-1793.83	25	10	80 x 30 mm	

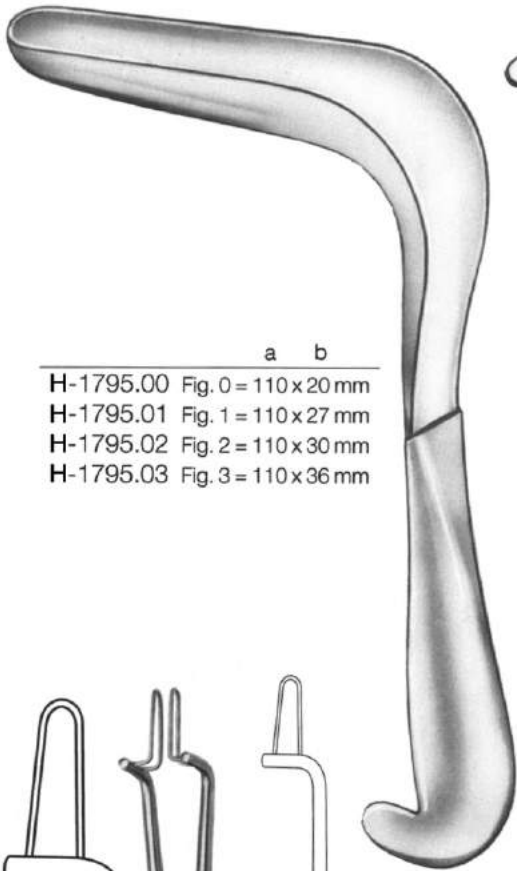

	a	b
H-1795.00	Fig. 0 = 110 x 20 mm	
H-1795.01	Fig. 1 = 110 x 27 mm	
H-1795.02	Fig. 2 = 110 x 30 mm	
H-1795.03	Fig. 3 = 110 x 36 mm	

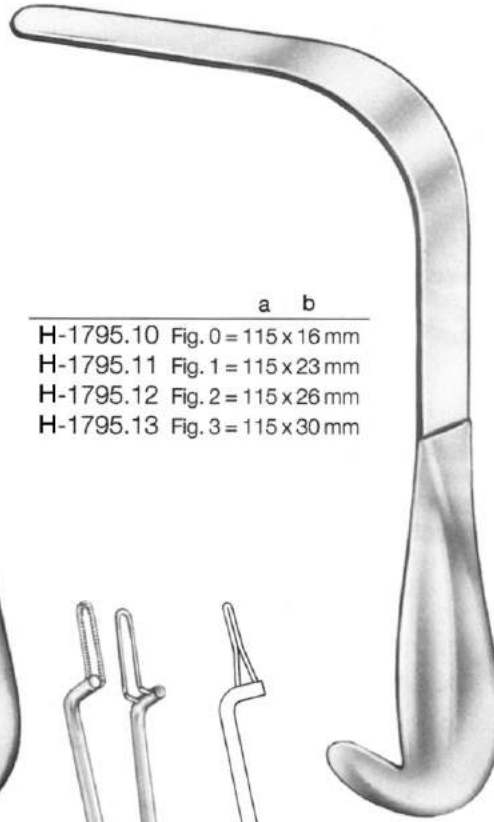

	a	b
H-1795.10	Fig. 0 = 115 x 16 mm	
H-1795.11	Fig. 1 = 115 x 23 mm	
H-1795.12	Fig. 2 = 115 x 26 mm	
H-1795.13	Fig. 3 = 115 x 30 mm	

Fig. 0	H-1795.20
Fig. 1	H-1795.21
Fig. 2	H-1795.22
Fig. 3	H-1795.23

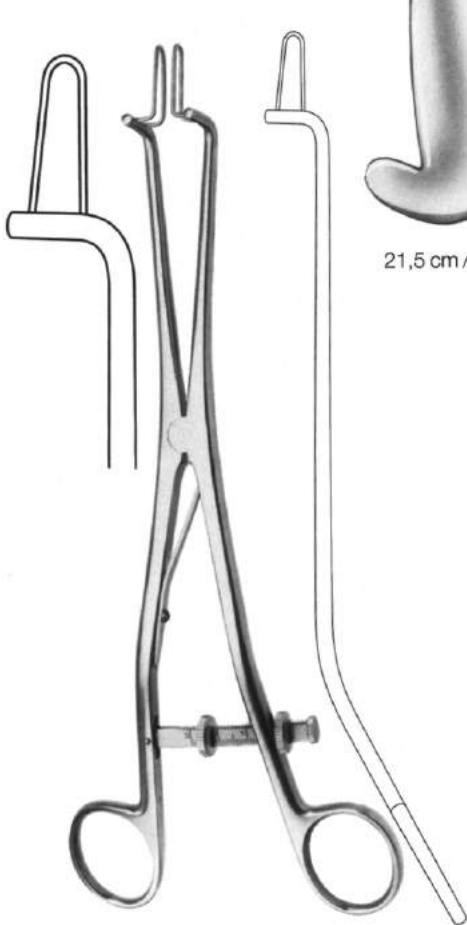

21,5 cm / 8 1/2"

Kogan
24 cm / 9 1/2"
H-2202.24



Kogan modif.
28 cm / 11"
H-2206.28

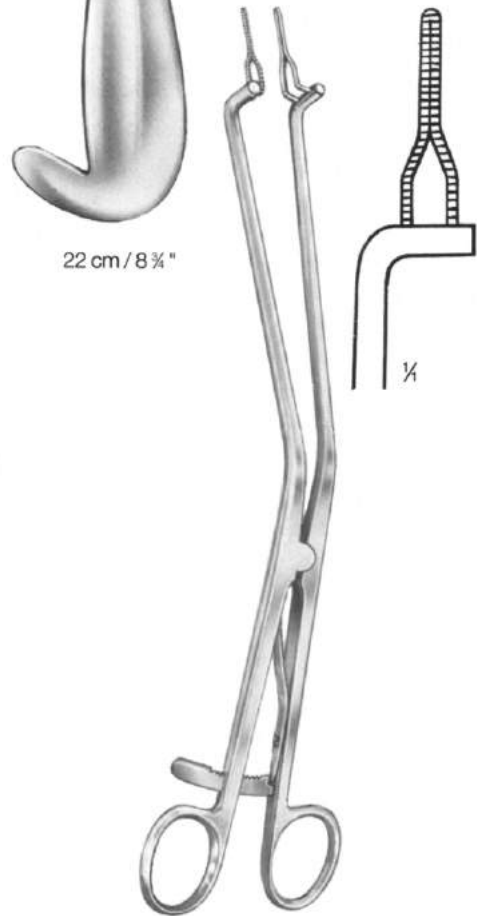

22 cm / 8 3/4"

Kogan "Thin Line"
28 cm / 11"
H-2208.28

Endospecula for Cervix und Urethra

Uterine Sounds

graduated in centimeters

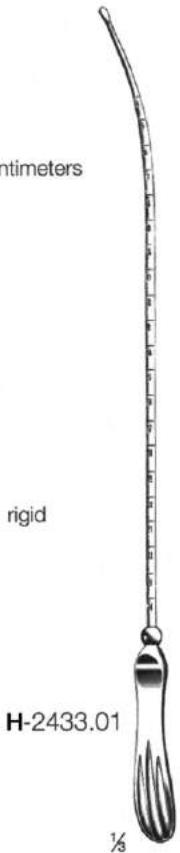

rigid

H-2433.01

1/8

Sims

33 cm, 13"

malleable

H-2433.14



plain

rigid

H-2433.03

1/8

Sims

33 cm, 13"

malleable

H-2433.34

Uterine Depressors



1/8

Valleix

30 cm, 12"

H-2483.30



1/8

Braun

27 cm/10 1/2"

H-2511.27



1/8



1/8

Sims

26 cm/10 1/4"

H-2513.26



1/8

Doyen

17 cm/6 3/4"

H-2550.17



1/8

Doyen

15 cm, 6"

H-2552.15

Cervical Biopsy and Specimen Forceps

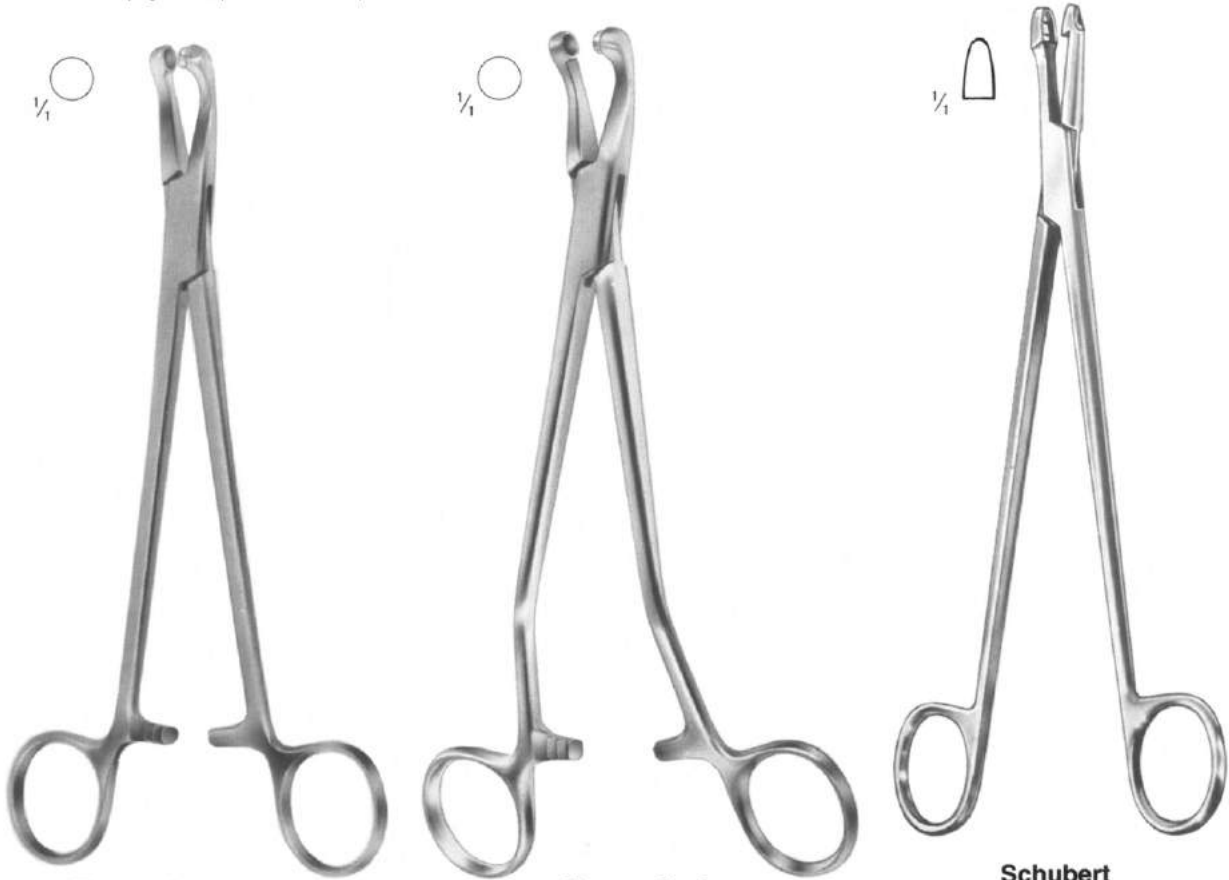

Thoms-Gaylor

H-3010.22

22 cm/8 ½"

H-3010.24

24 cm/9 ½"

Thoms-Gaylor

H-3013.22

H-3013.24

Schubert

H-3030.21 = 21 cm/8 ¼"

H-3030.29 = 29 cm/11 ½"

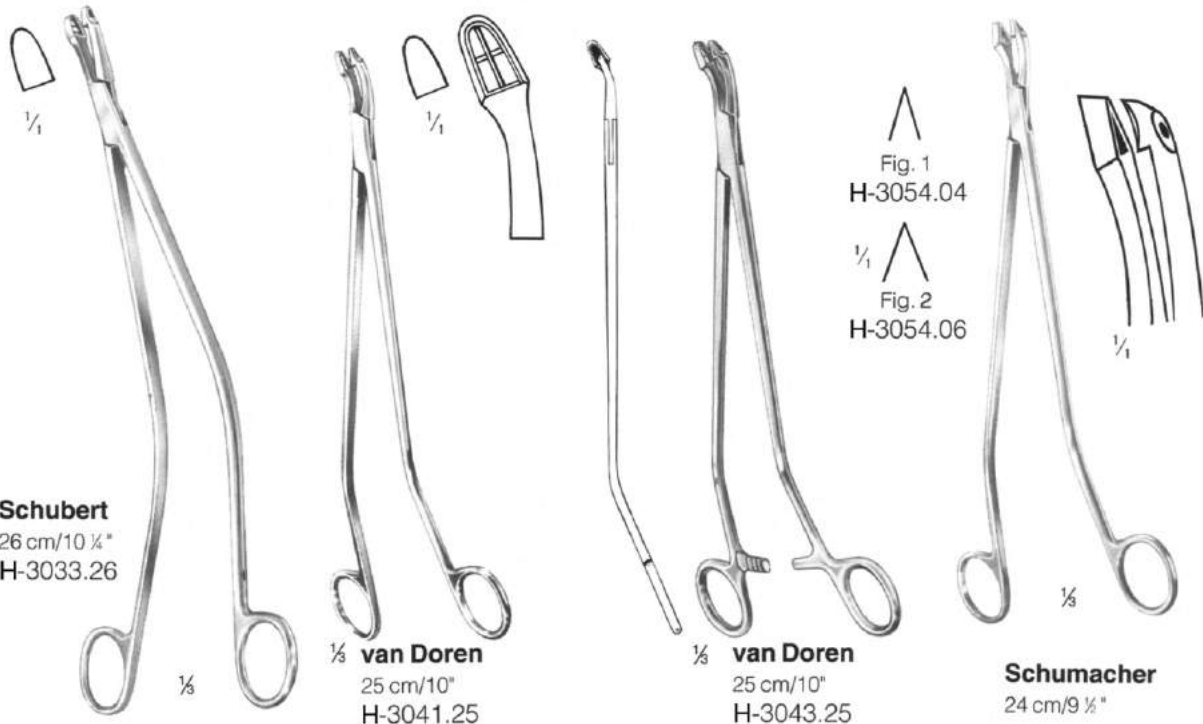

Schubert

26 cm/10 ¼"

H-3033.26

van Doren

25 cm/10"

H-3041.25

van Doren

25 cm/10"

H-3043.25

Schumacher

24 cm/9 ½"

Cervical Biopsy and Specimen Forceps

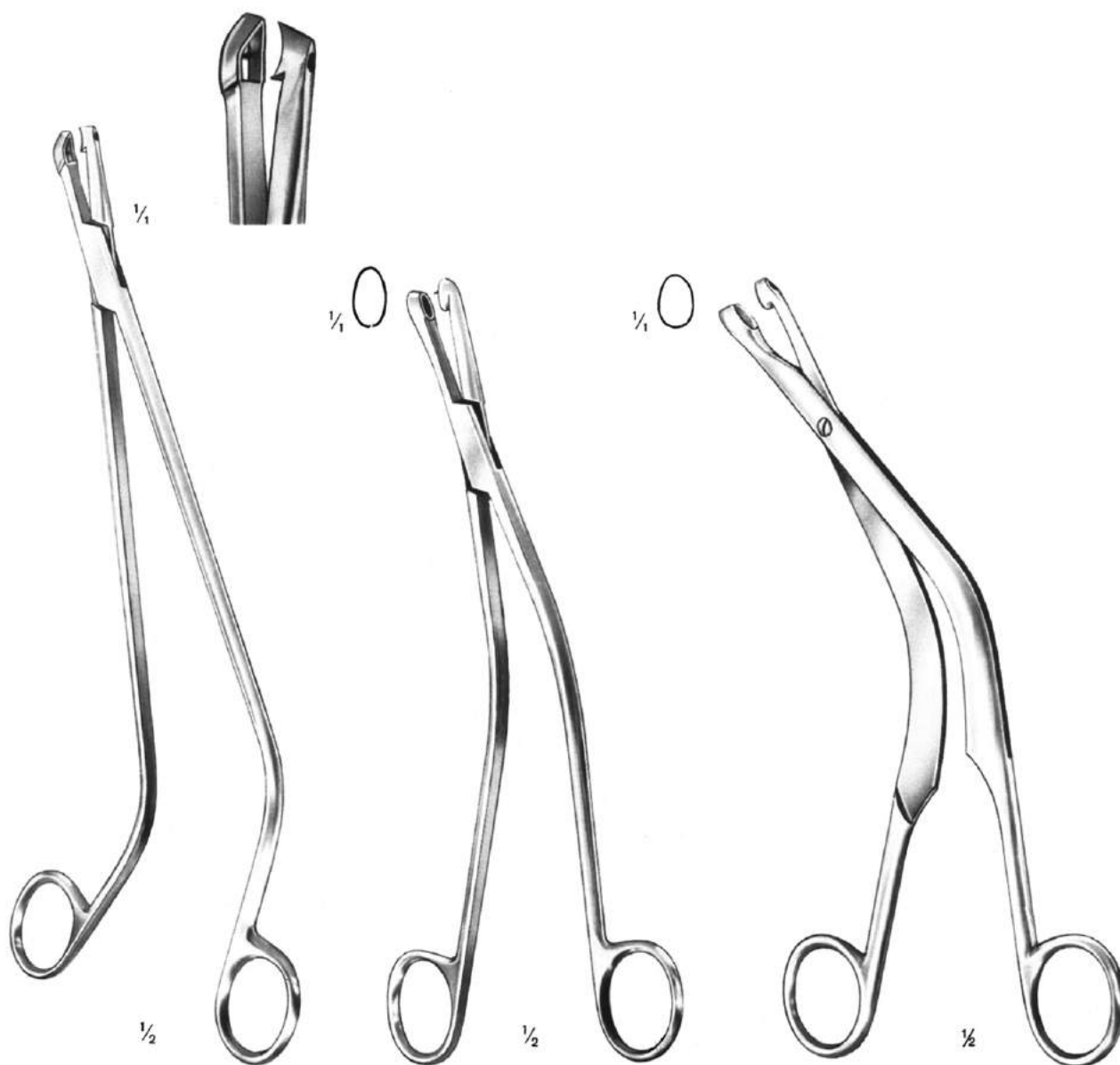

Tischler
27 cm/10 1/2"
H-3071.27

Gellhorn
23 cm/9"
H-3075.23

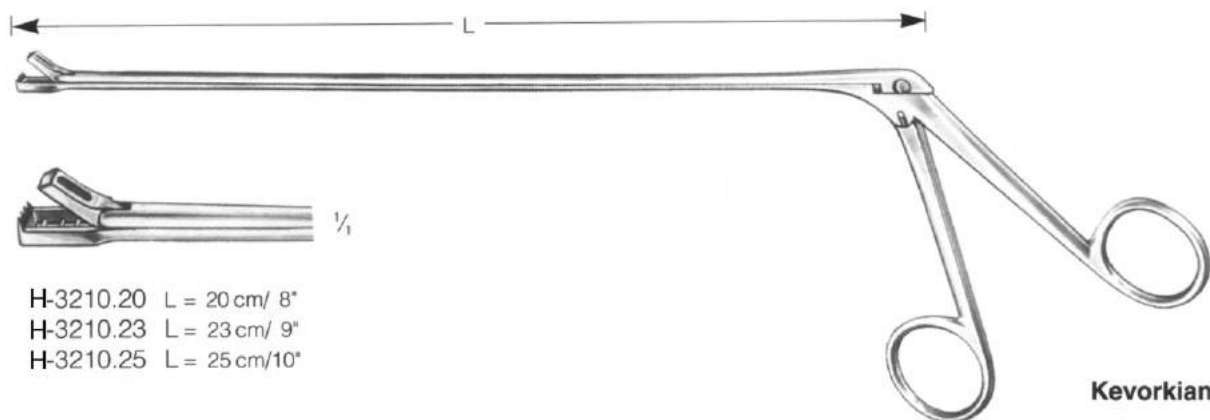

Faure
23 cm/9"
H-3089.23

Cervical Biopsy and Specimen Forceps

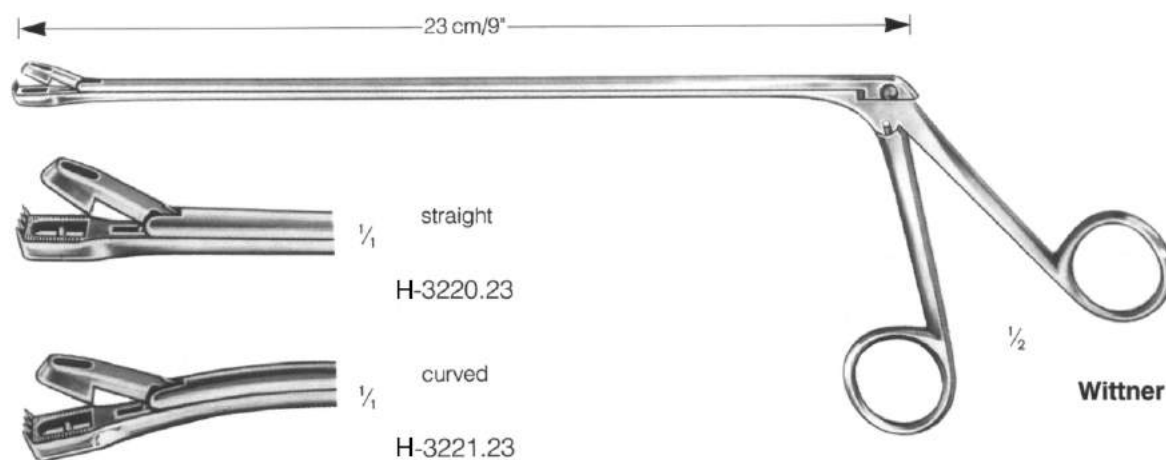
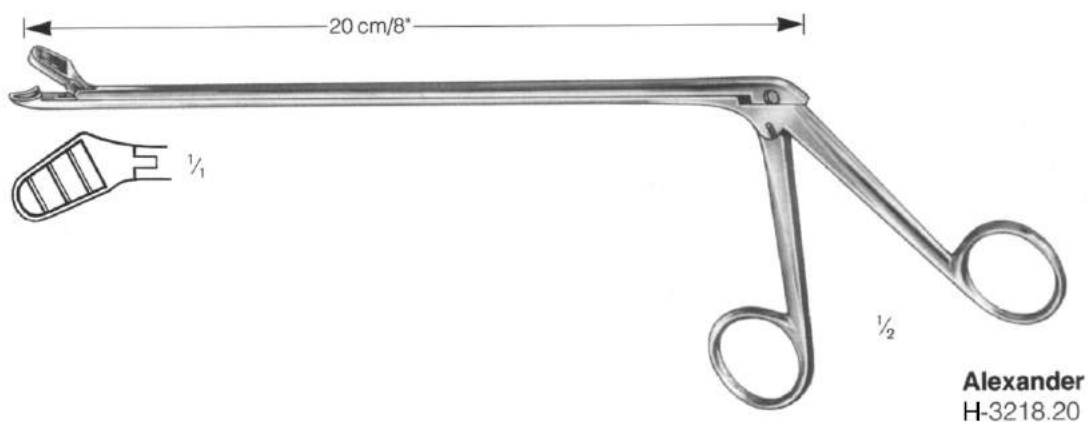

- H-3210.20 L = 20 cm/ 8"
- H-3210.23 L = 23 cm/ 9"
- H-3210.25 L = 25 cm/10"



-  $\frac{1}{4}$ straight
H-3220.23
-  $\frac{1}{4}$ curved
H-3221.23

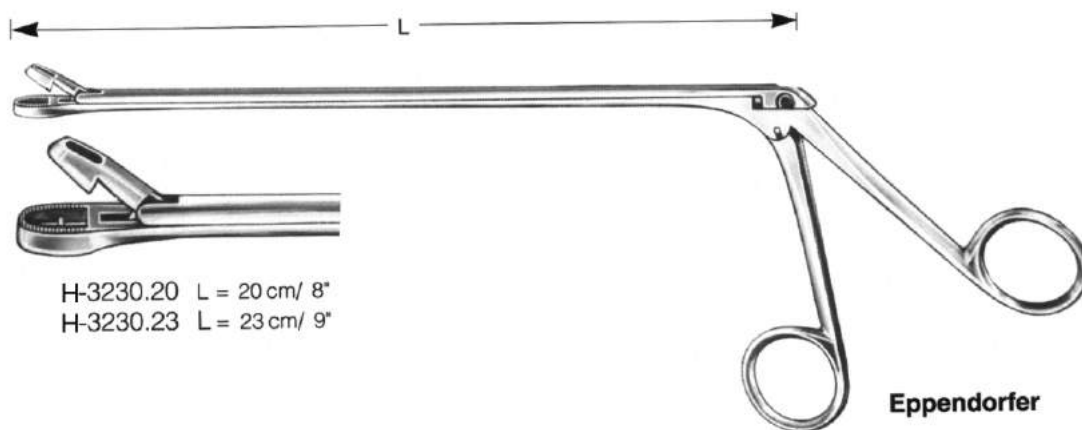

Eppendorfer

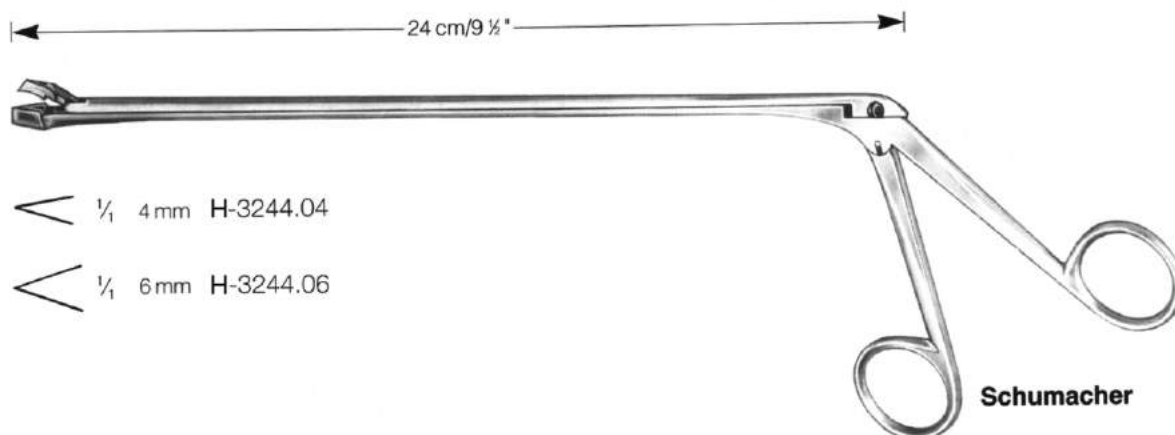

Schumacher

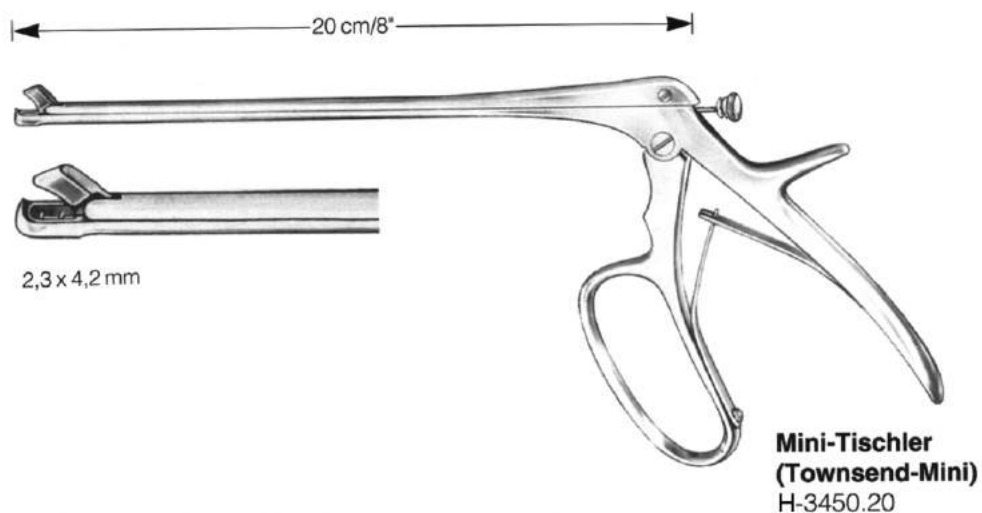

**Mini-Tischler
(Townsend-Mini)
H-3450.20**

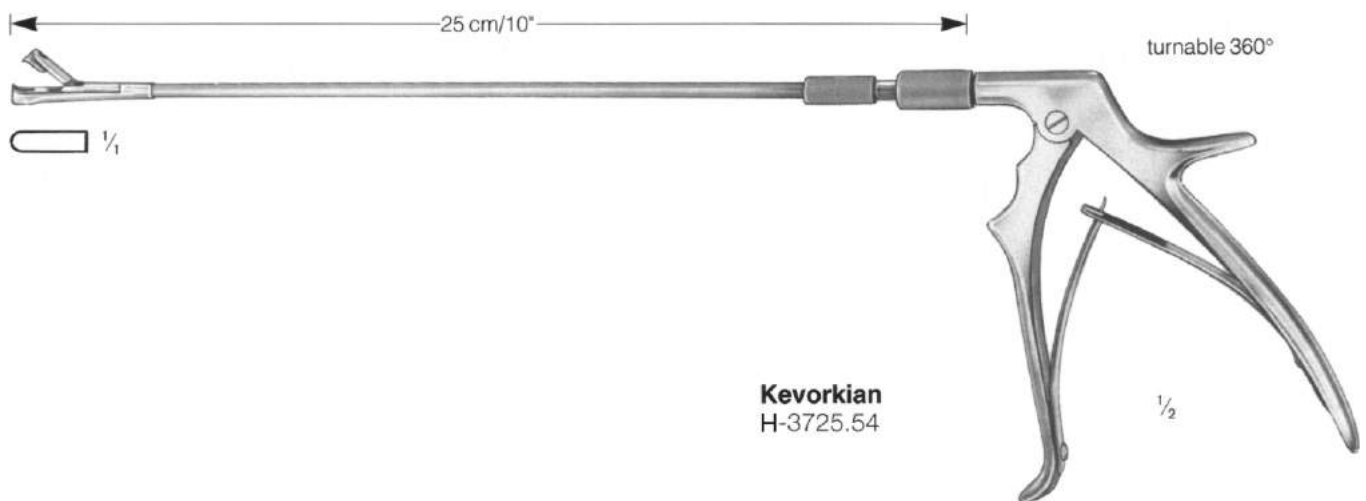
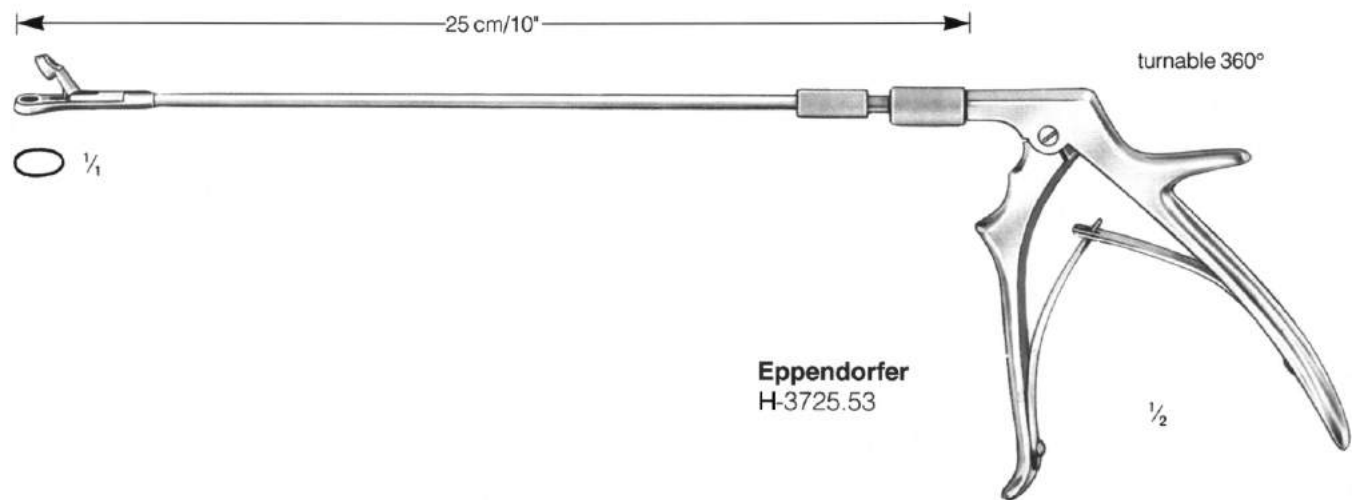
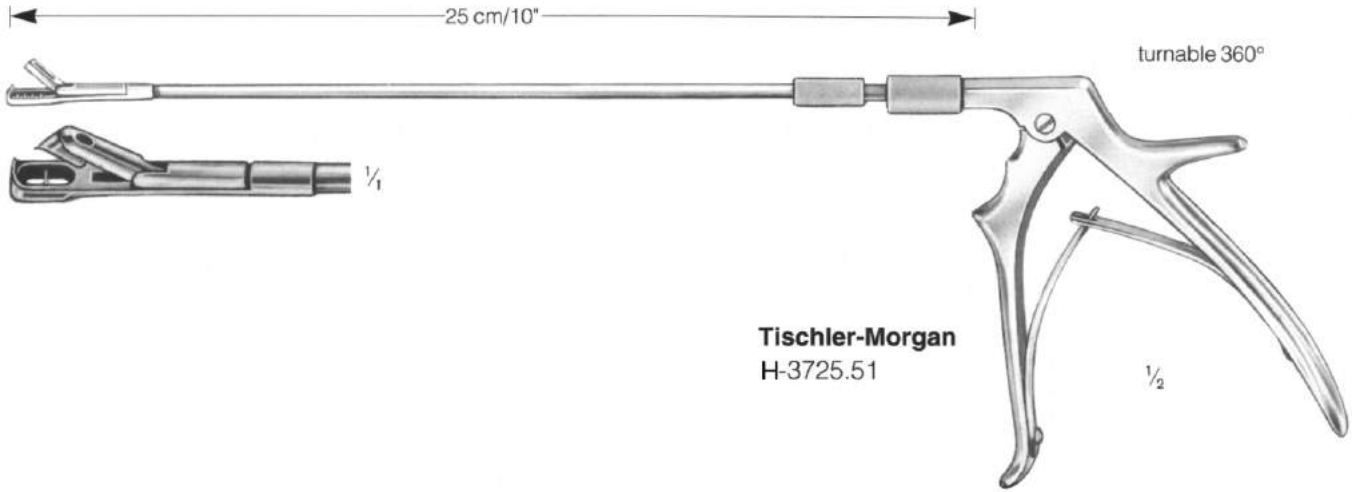

Suction Biopsy Curettes

Uterine Biopsy Aspirating Curettes



Randall
25 cm/10"
H-4025.04

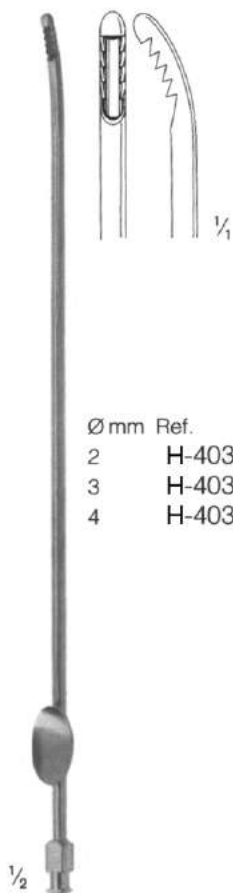

Novak
25 cm/10"

Ø mm	Ref.
2	H-4035.02
3	H-4035.03
4	H-4035.04

Endometrial Biopsy Curette



Mod. Berlin
27 cm/10 3/4"
H-4067.35

Uterine Secretion Scoop

malleable



stumpf
blunt
romas
mousses

27,5 cm/10 3/4"
H-4092.27



CARTON
H-0570.30
30 cm/12"
5 mm dia



BOZEMANN - FRITSCH
H-0590.08 8 mm dia
H-0590.10 10 mm dia
H-0590.12 12 mm dia



SPACKMANN
H-0610.18
18 cm/7"

Uterine Cannula



SPACKMANN
H-0620.35

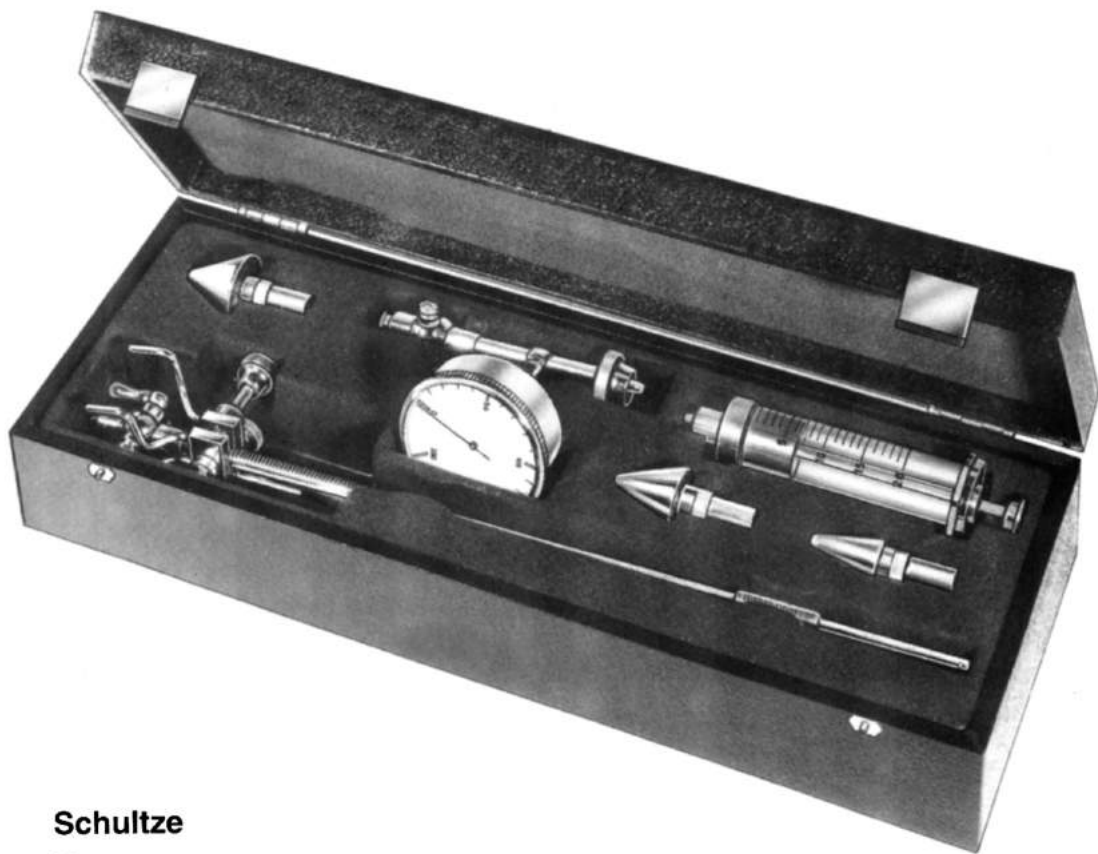

Schultze

H-4820.40
Salpingograph

Uterine Curettes, Uterine Scoops

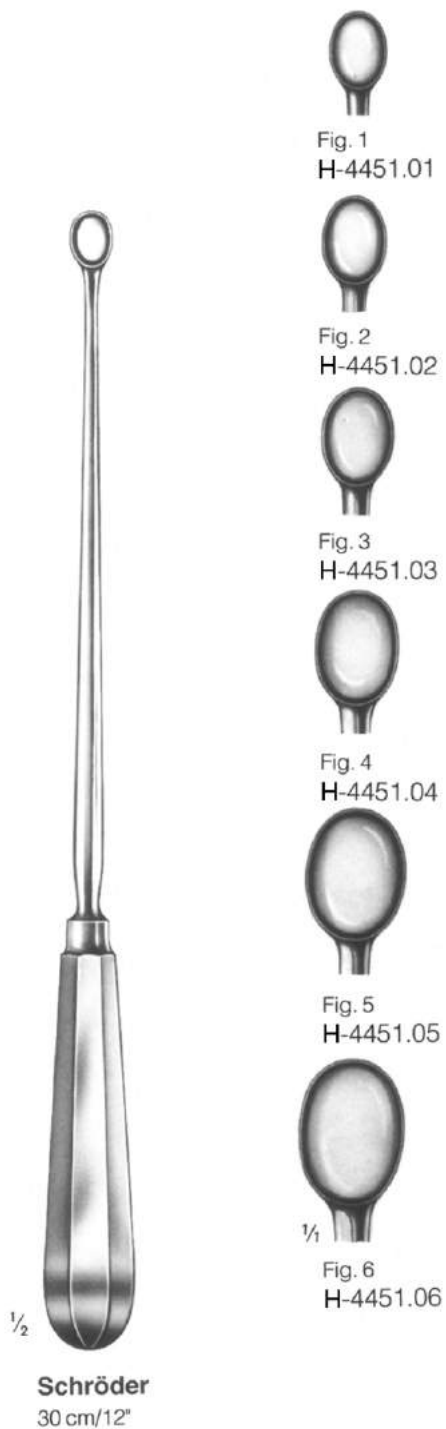

Uterine Curettes

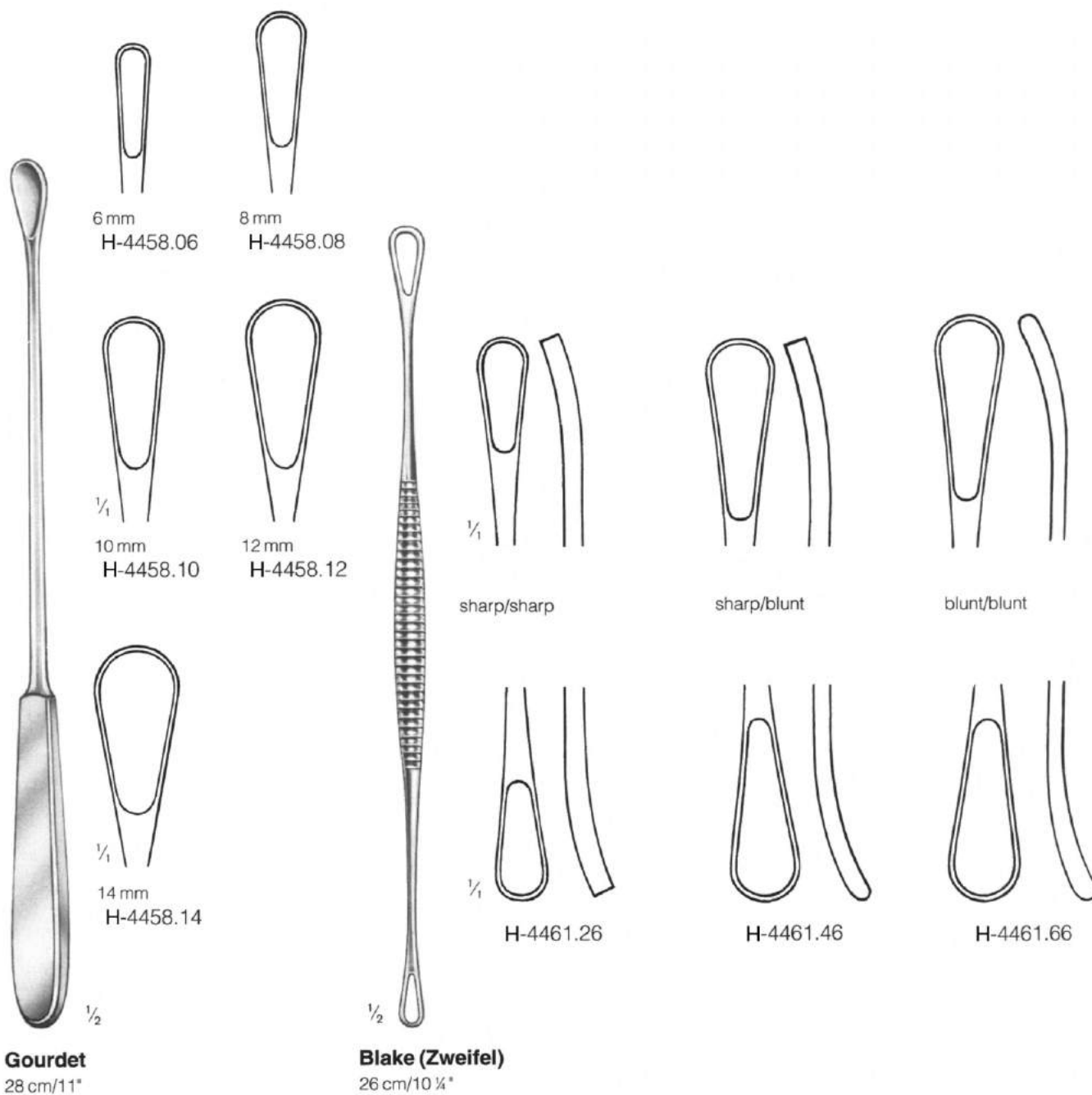

Uterine Curettes



Recamier
max. 31 cm / 12 1/2"

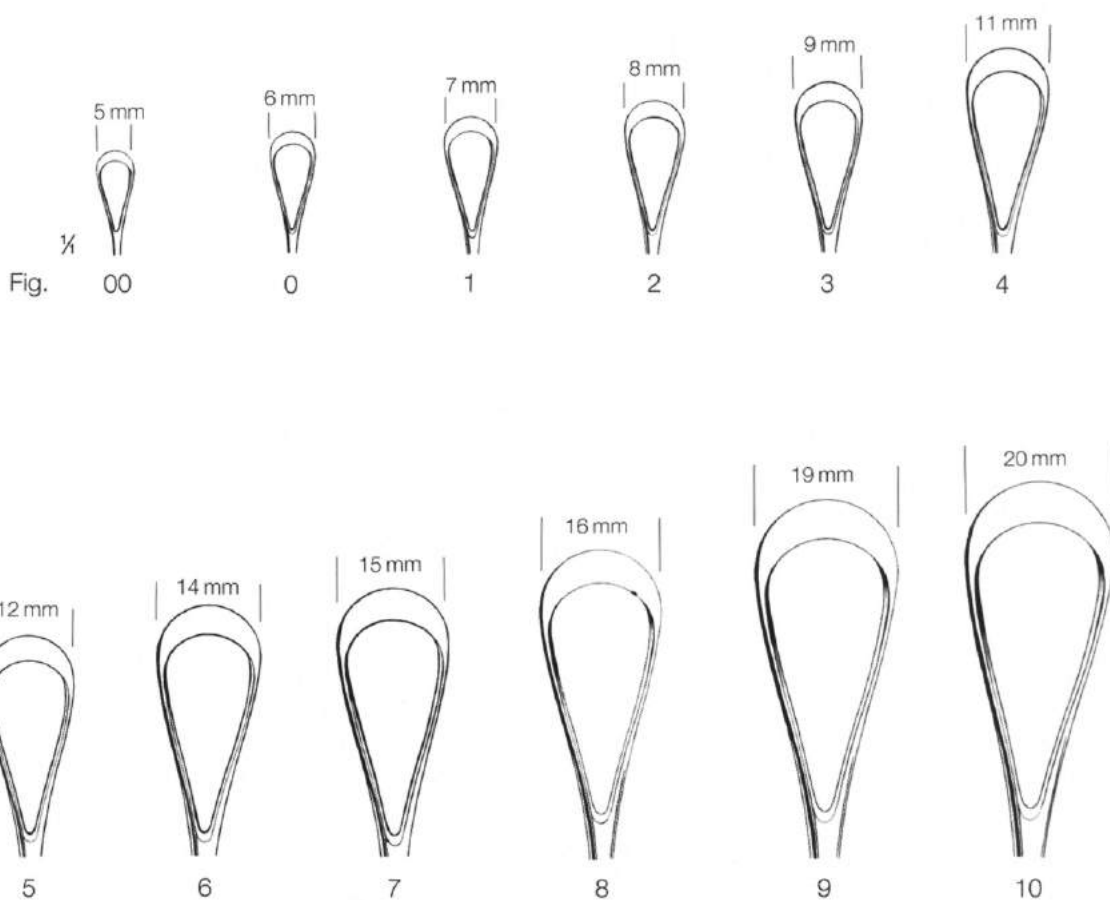

sharp

blunt

rigid

malleable

rigid

malleable

		Fig.		
H-4510.05	H-4511.05	00	H-4512.05	H-4513.05
H-4510.06	H-4511.06	0	H-4512.06	H-4513.06
H-4510.07	H-4511.07	1	H-4512.07	H-4513.07
H-4510.08	H-4511.08	2	H-4512.08	H-4513.08
H-4510.09	H-4511.09	3	H-4512.09	H-4513.09
H-4510.11	H-4511.11	4	H-4512.11	H-4513.11
H-4510.12	H-4511.12	5	H-4512.12	H-4513.12
H-4510.14	H-4511.14	6	H-4512.14	H-4513.14
H-4510.15	H-4511.15	7	H-4512.15	H-4513.15
H-4510.16	H-4511.16	8	H-4512.16	H-4513.16
H-4510.19	H-4511.19	9	H-4512.19	H-4513.19
H-4510.20	H-4511.20	10	H-4512.20	H-4513.20

Uterine Curettes



Sims
26 cm/10 ¼"



Fig. 1



Fig. 2



Fig. 3



Fig. 4



Fig. 5



Fig. 6

sharp

blunt

rigid

malleable

rigid

malleable

H-4560.51
H-4560.52
H-4560.53
H-4560.54
H-4560.55
H-4560.56

H-4561.51
H-4561.52
H-4561.53
H-4561.54
H-4561.55
H-4561.56

Fig.
1
2
3
4
5
6

H-4562.51
H-4562.52
H-4562.53
H-4562.54
H-4562.55
H-4562.56

H-4563.51
H-4563.52
H-4563.53
H-4563.54
H-4563.55
H-4563.56

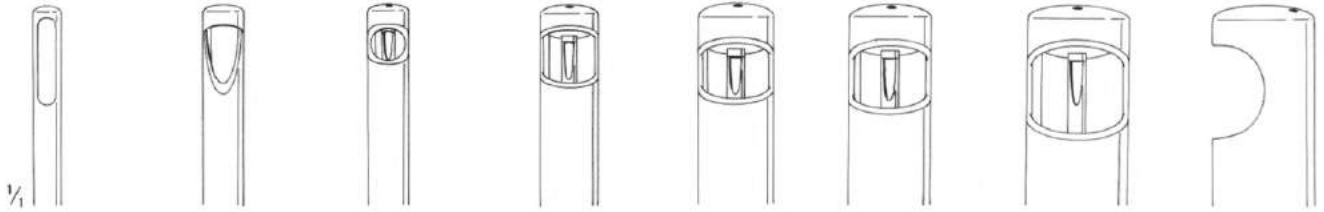

H-4601.03
3 mm Ø

H-4601.04
4,5 mm Ø

H-4601.06
6 mm Ø

H-4601.08
8 mm Ø

H-4601.10
10 mm Ø

H-4601.12
12 mm Ø

H-4601.14
14 mm Ø

H-4601.50

Specimen and Aspirating Curettes

Aspirating Curettes

Hose Connection



¼

Breisky
33 cm/ 13 "
H-6010.33



¼

Collyer
30,5 cm/ 12 "
H-6030.30

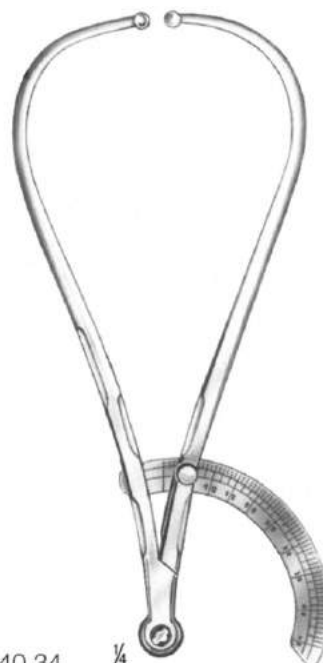

¼

H-6040.34
cm/inches scale

Martin
34 cm/ 13 ½ "

H-6041.34
cm scale



Naegele
H-7310.36 = 36 cm/ 14 "
H-7310.40 = 40 cm/ 15 ½ "



¼

Kielland
41 cm/ 16 ¼ "
H-7330.41



¼

Piper
44 cm/ 17 ½ "
H-7335.44



¼

Simpson
30,5 cm/ 12 "
H-7374.30



WRIGLEY
H-7310.23 23 cm



ELLIOT
H-7402.32 32cm
H-7402.38 38cm



SIMPSON.LUIKART
H-7410.36 36cm



LUIKART
H-7410.40 40cm



DE.LEE
H-7312.30 30cm
H-7312.36 36cm
H-7312.39 39cm



Kielland-luikart
H-7414.40



Simpson-Braun
36 cm/14"
H-7374.36



Boerma
29 cm/11 1/2"
H-7402.29



Sellheim
28 cm/11"
H-7205.28



LUIKART-BILL
H-3171.21

Placenta and Ovum Curettes, Scoops

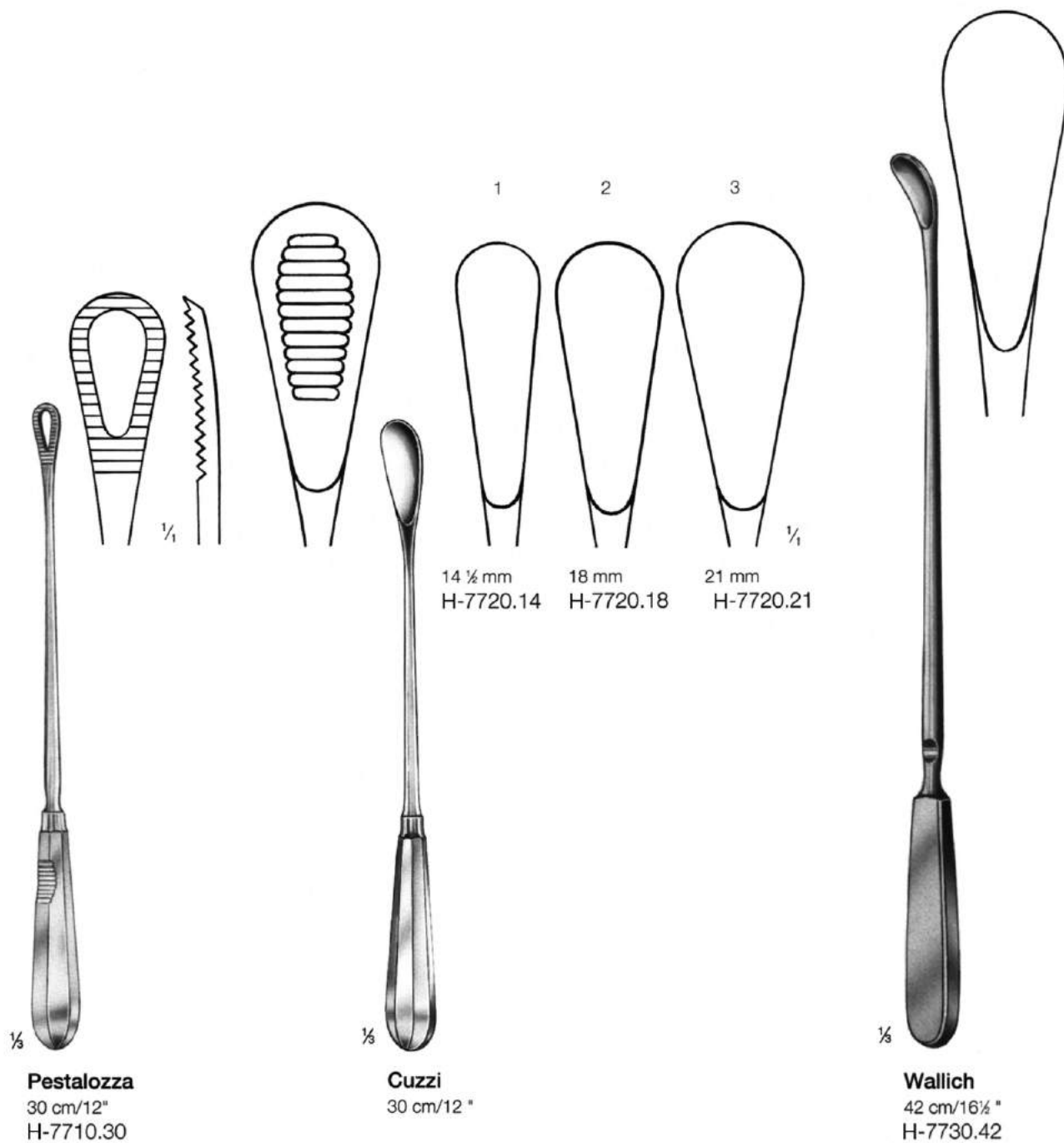

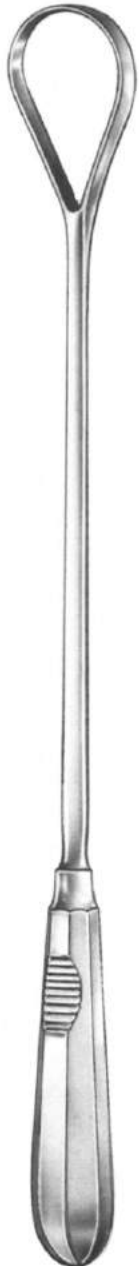

Recamier-Bumm



1/4

Fig. 11
21 mm



Fig. 12
23 mm



Fig. 13
25 mm

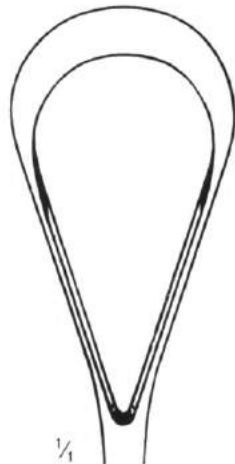

1/4

Fig. 14
30 mm
sharp

rigid



Fig. 15
35 mm

malleable

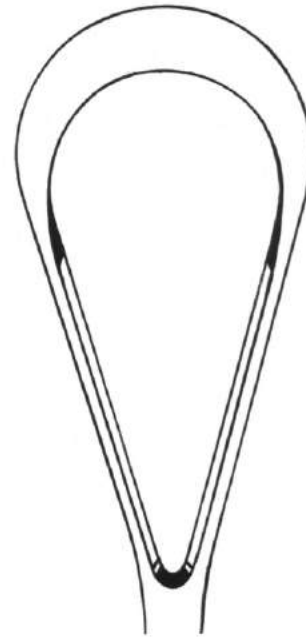

Fig. 16
40 mm

blunt

rigid

malleable

31 cm / 12 1/2"

Fig.

H-4510.21
H-4510.23

H-4511.21
H-4511.23

11
12

H-4512.21
H-4512.23

H-4513.21
H-4513.23

34 cm / 13 1/2"

Fig.

H-4510.25
H-4510.30
H-4510.35
H-4510.40

H-4511.25
H-4511.30
H-4511.35
H-4511.40

13
14
15
16

H-4512.25
H-4512.30
H-4512.35
H-4512.40

H-4513.25
H-4513.30
H-4513.35
H-4513.40

Umbilical Cord Clamps

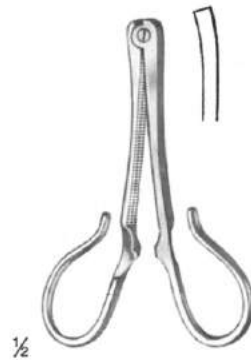

½
Kane
8,5 cm, 3 ½"
H-8210.85



½
Collin
9 cm, 3 ½"
H-8212.90

Amniotomes for the



½
Beacham
26 cm / 10 ¼"
H-7910.26

transvaginal injection for paracervical anaesthesia



½
IOWA
14 cm, 5 ½"
H-8310.14

Trumpet Needle Guide





½
IOWA
14 cm, 5 ½"
H-8311.14

Injection Needle
1.00 x 160 mm
Luer-Lock

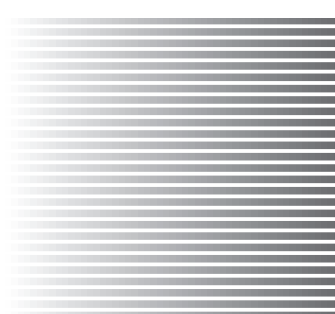

½
IOWA
H-8312.16

- 
- 
- 
- Stomach, intestine, rectum
 - Estomac, intestin, rectum
 - Estómago, intestino, recto

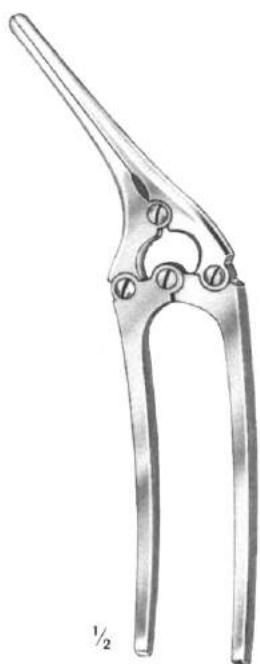

1/2

Payr-Baby
 18 cm/7"

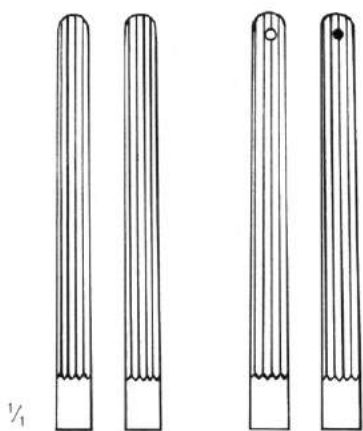

1/1

I-0120.18

without pin

I-0130.18

with pin

Intestinal and Stomach Clamps

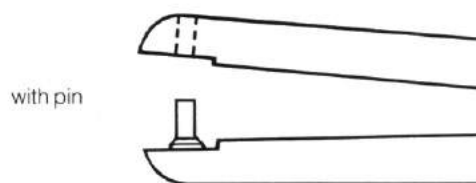

with pin

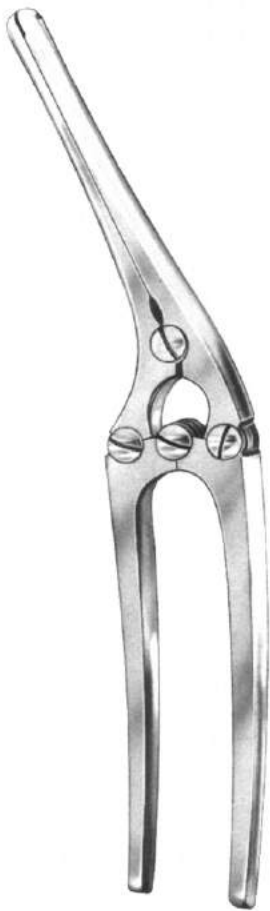

Payr

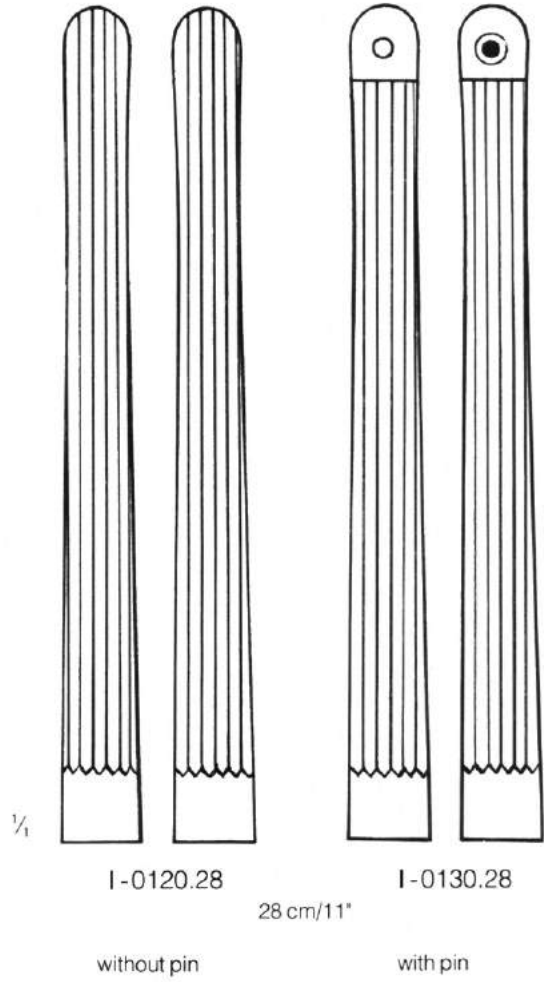
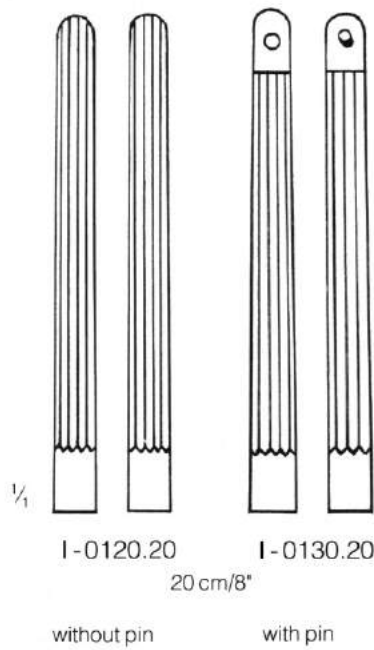

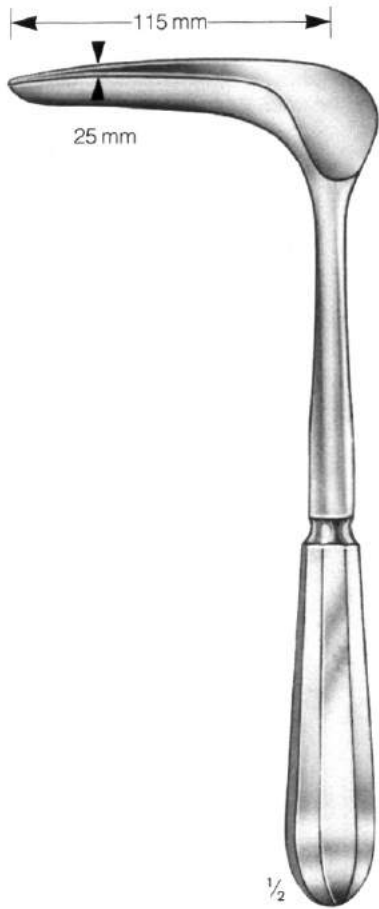

Rectal specula

Czerny
22 cm/8 3/4"
I-0510.22

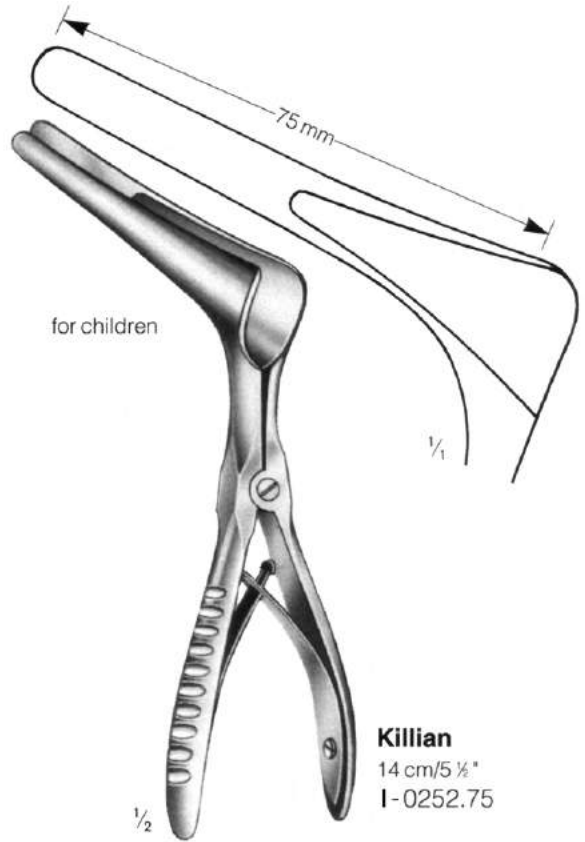

for children

Killian
14 cm/5 1/2"
I-0252.75



Bodenhammer (Sims)
15 cm/6"
I-0530.16



Sims
15 cm/6"
I-0532.16

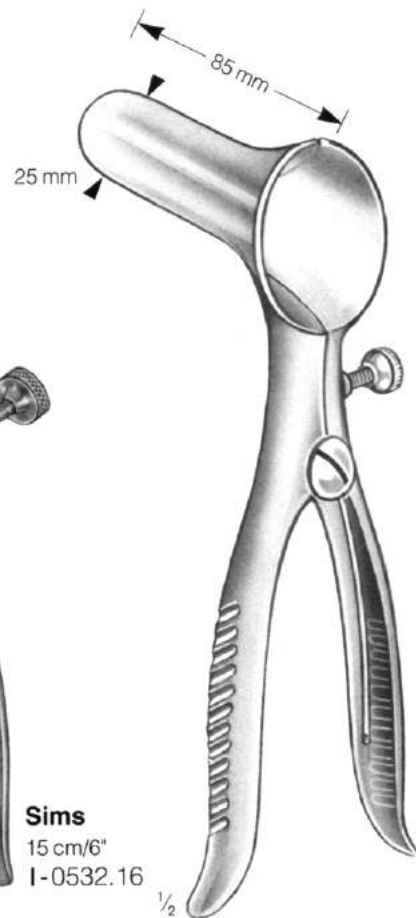

Pratt
22 cm/8 3/4"
I-0534.22

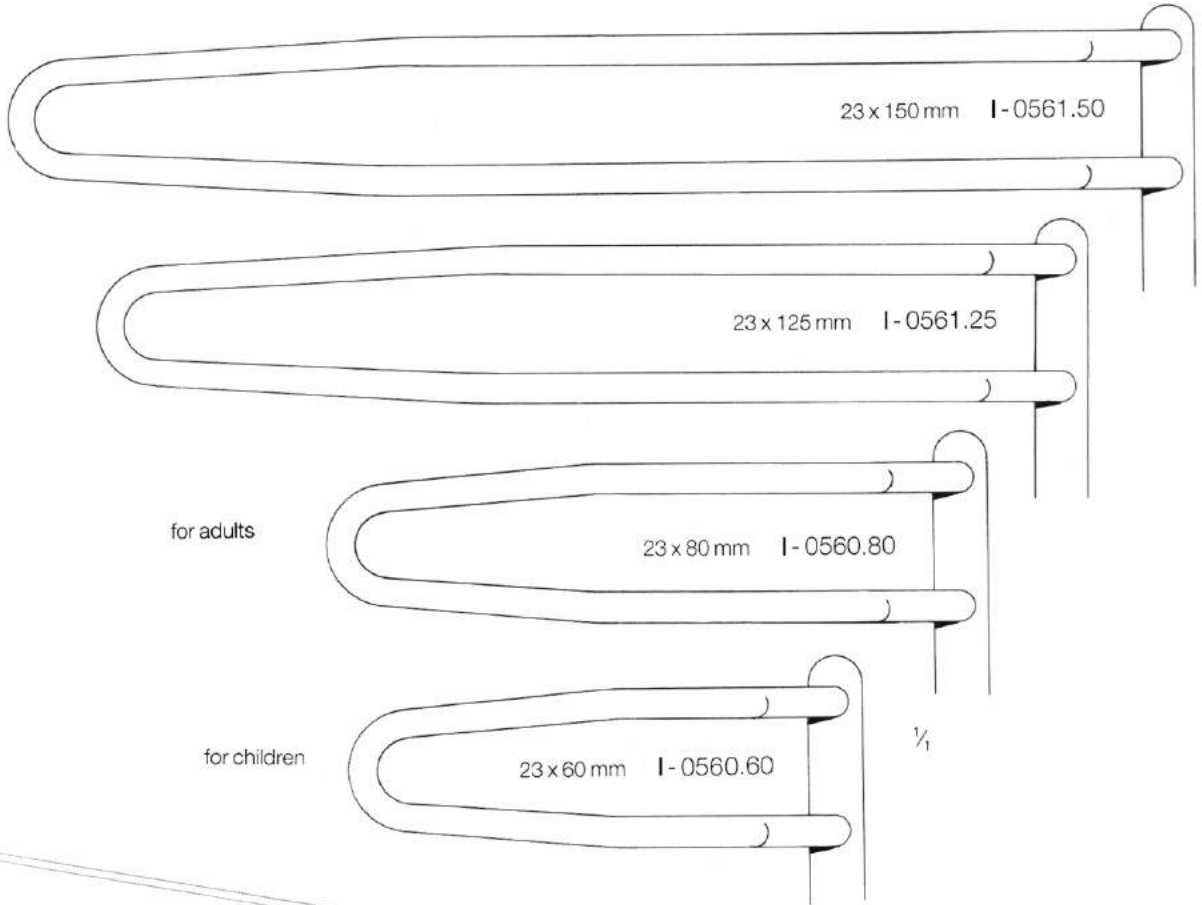

Mathieu
 19 cm 7 1/2"
 I-0543.19

1/2



Sims
 (Schulze-Bergmann)
 22 cm 8 3/4"

1/2

Sphincteroscopes

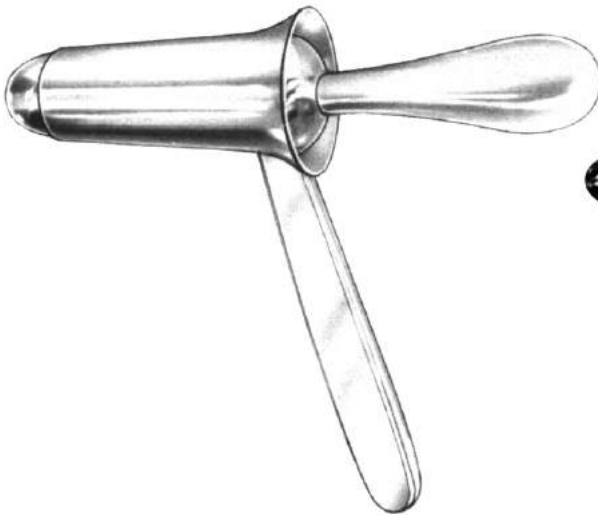

Kelly
 Ø 21 mm x 50 mm I-0601.21
 Ø 25 mm x 50 mm I-0601.25

Proctoscopes



Kelly
 Ø 22 mm x 50 mm I-0722.05
 Ø 22 mm x 100 mm I-0722.10
 Ø 22 mm x 145 mm I-0722.14
 Ø 22 mm x 200 mm I-0722.20

Anoscopes



Hirschmann

Fig 1 Ø 16 mm x 65 mm I-0806.16
 Fig 2 Ø 19 mm x 65 mm I-0806.19
 Fig 3 Ø 22 mm x 65 mm I-0806.22

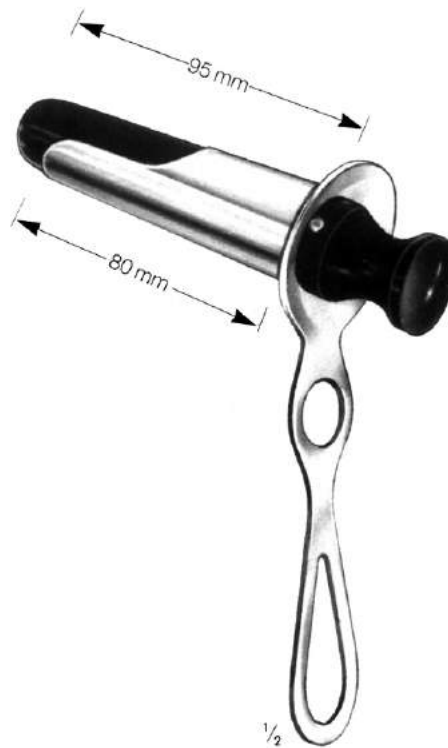

Ives-Fansler

22 mm Ø
 I-0826.22

Rectal Biopsy Forceps

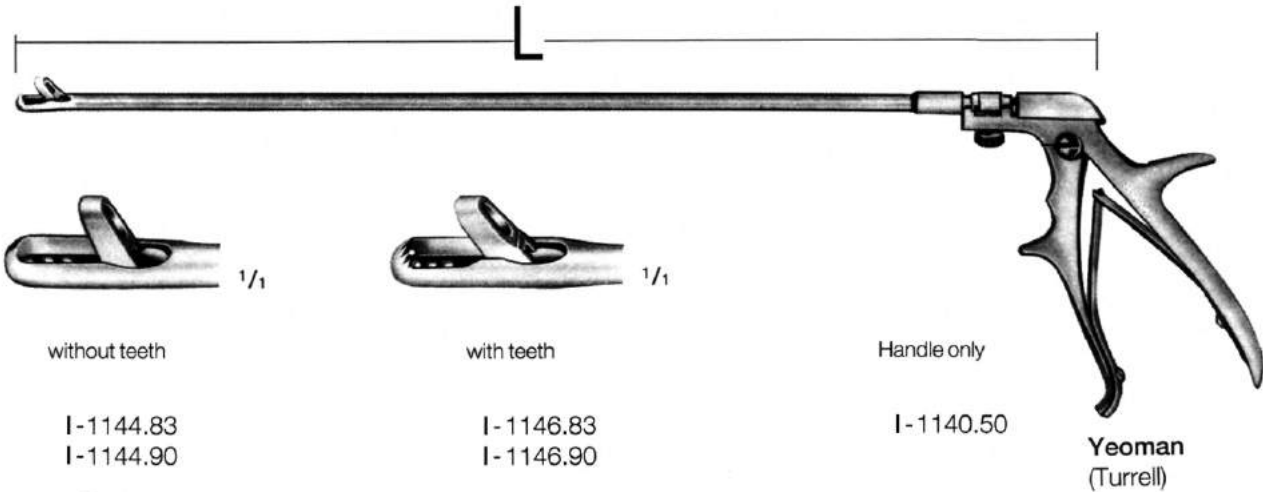

I-1144.83
I-1144.90

I-1146.83
I-1146.90

I-1140.50

Yeoman
(Turrell)

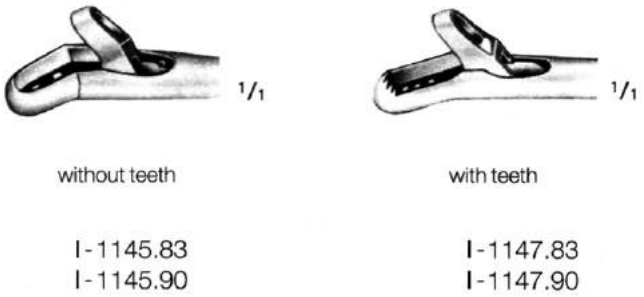

I-1145.83
I-1145.90

I-1147.83
I-1147.90

Forceps with handle	L	Stem only
I-1144.83	33 cm, 13"	I-1144.33
I-1144.90	40 cm, 16"	I-1144.40
I-1145.83	33 cm, 13"	I-1145.33
I-1145.90	40 cm, 16"	I-1145.40
I-1146.83	33 cm, 13"	I-1146.33
I-1146.90	40 cm, 16"	I-1146.40
I-1147.83	33 cm, 13"	I-1147.33
I-1147.90	40 cm, 16"	I-1147.40

Interchangeable handles for Rectal Biopsy Specimen Forceps

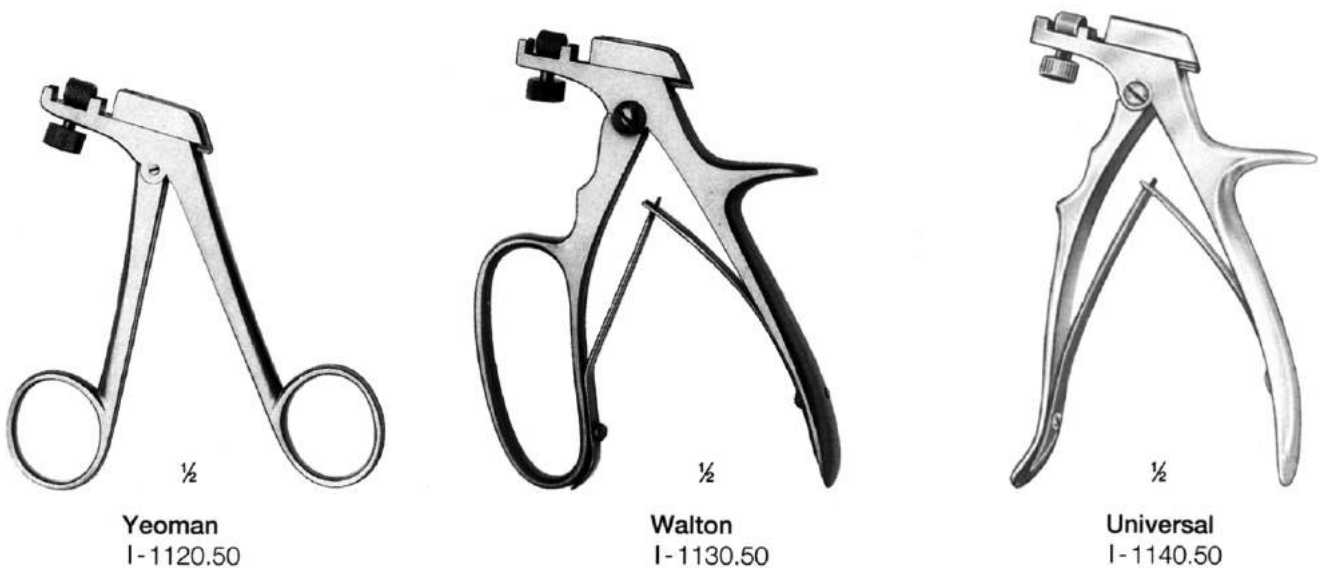

Yeoman
I-1120.50

Walton
I-1130.50

Universal
I-1140.50

Rectal Biopsy Forceps

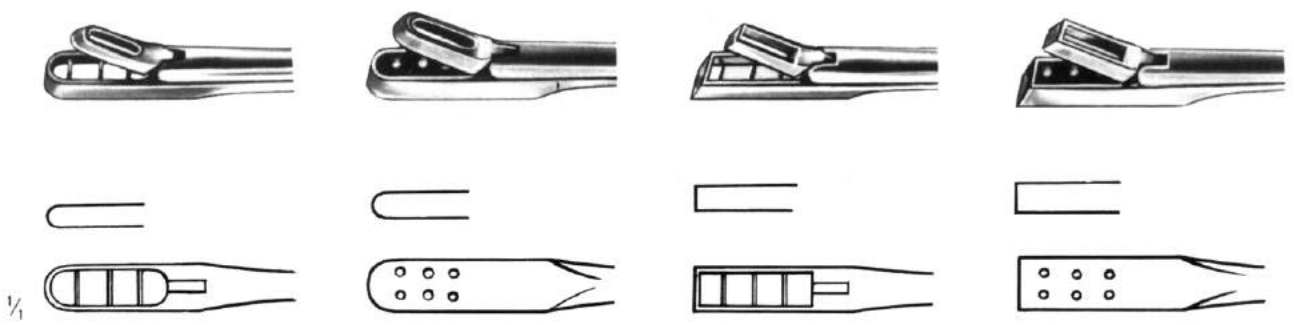
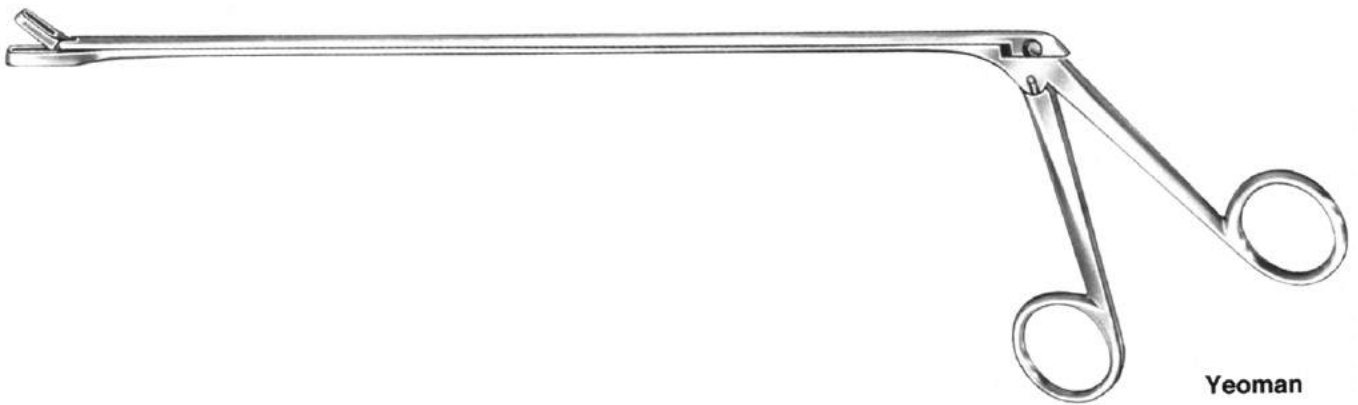
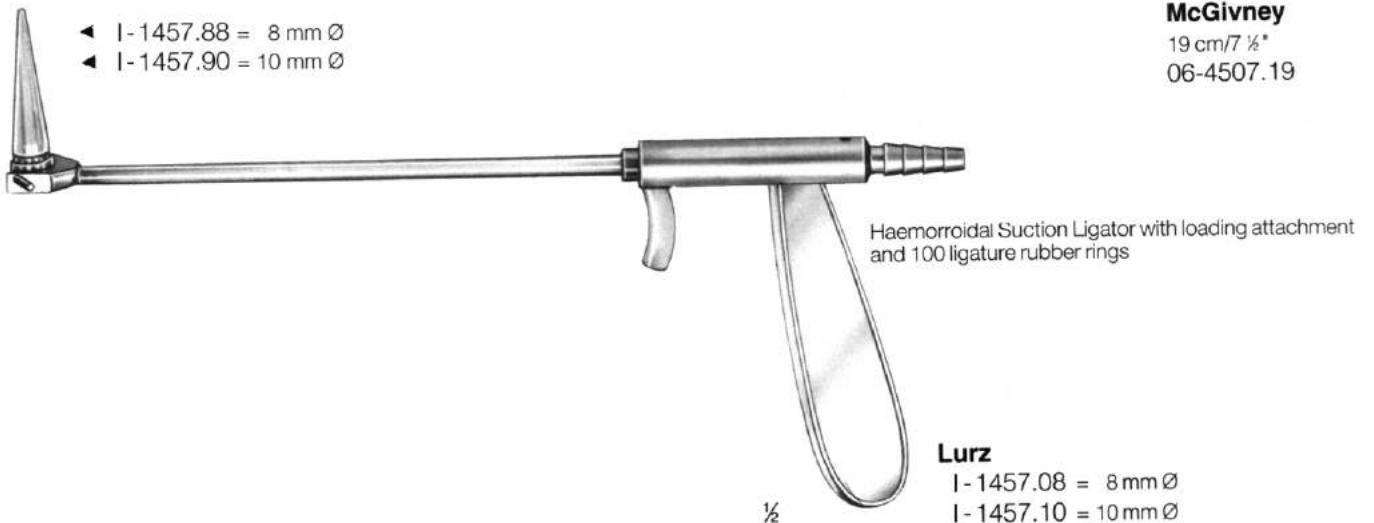
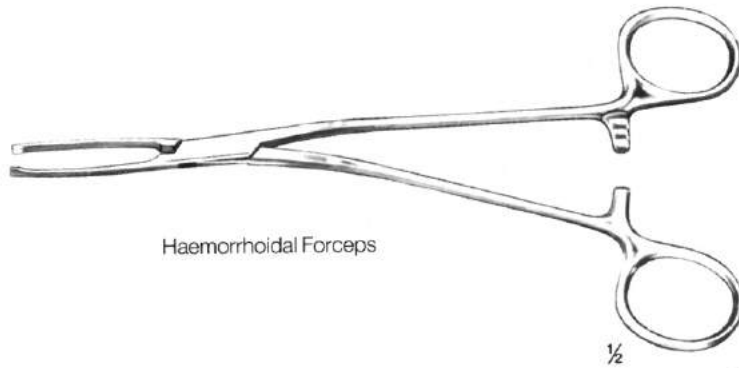
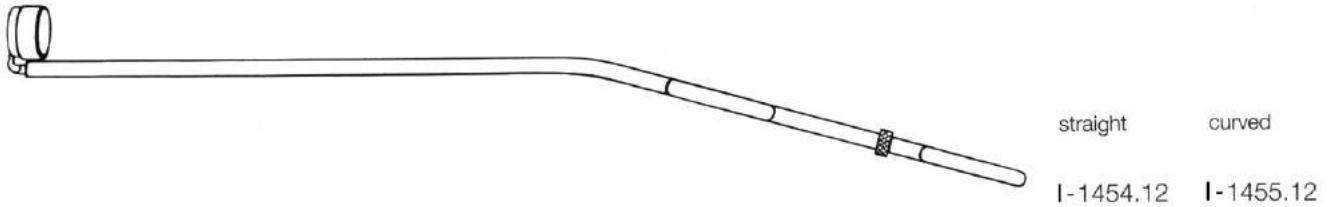
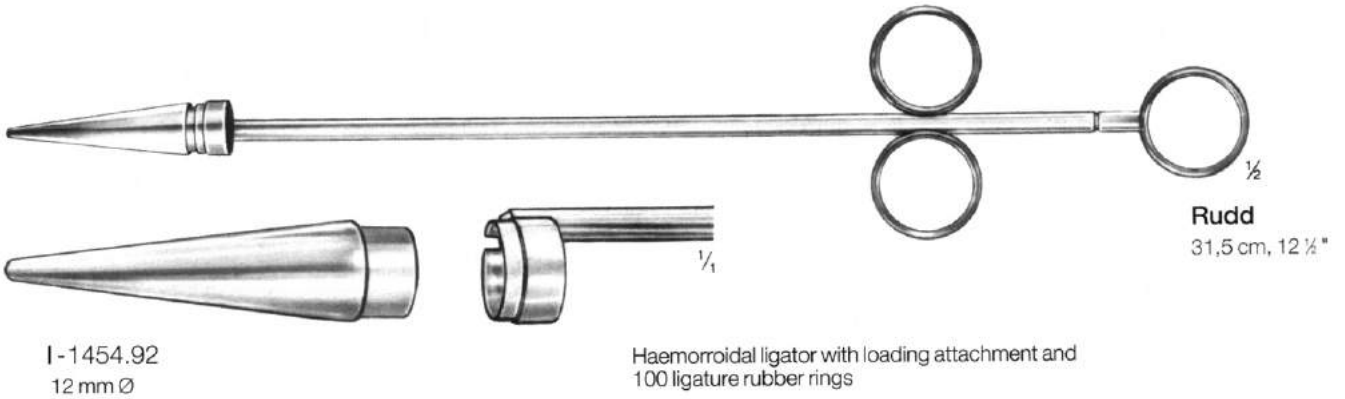

Fig. 1 Fig. 2 Fig. 3 Fig. 4

cm	inch.	Fig. 1	Fig. 2	Fig. 3	Fig. 4
28	11	I-1001.28	I-1002.28	I-1003.28	I-1004.28
35	13 3/4	I-1001.35	I-1002.35	I-1003.35	I-1004.35
42	16 1/2	I-1001.42	I-1002.42	I-1003.42	I-1004.42

Haemorrhoidal Ligators



Rectal Snares

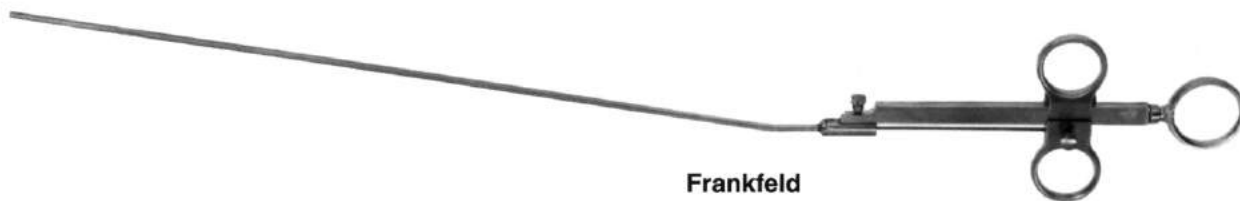

Frankfeld

working length: 30,5 cm/12"

I- 1510.31

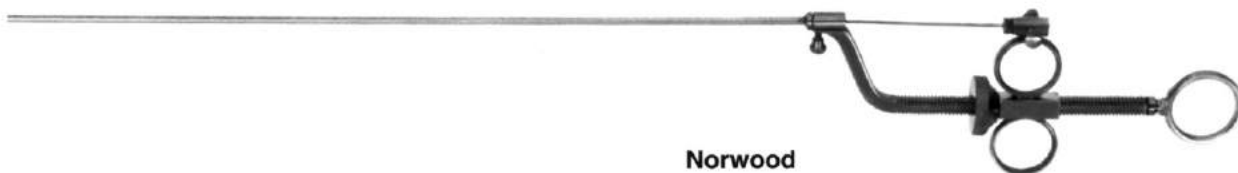

Norwood

working length: 30,5 cm/12"

I- 1521.31

Steel Wire for Rectal Snares



10 m, 33 ft.

0,3 mm	I- 1550.30
0,4 mm	I- 1550.40
0,5 mm	I- 1550.50



10 cm, 4"

0,3 mm	I- 1552.30
0,4 mm	I- 1552.40
0,5 mm	I- 1552.50

package of 12 pieces

Gall Duct Dilators

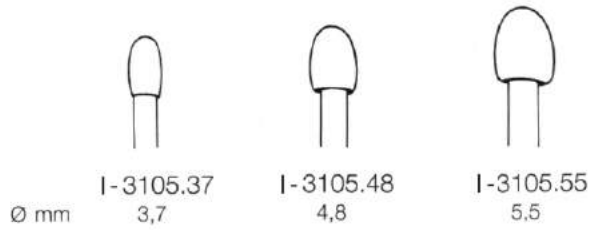
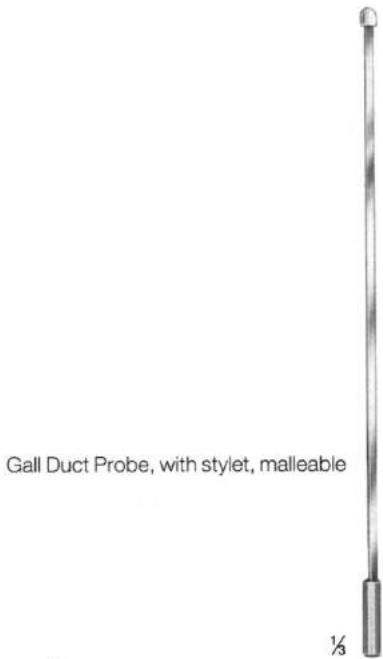

Desjardins
28 cm / 11"

Gall Stone Scoops



Ochsner(Fenger)
38 cm / 15"
I-3102.38



Moynihan
34 cm / 13 1/2"
I-3110.34



Mayo
26 cm / 10 1/2"

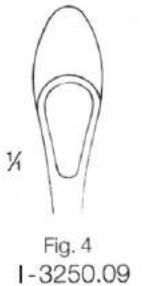
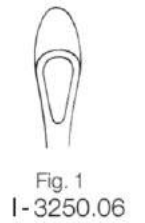
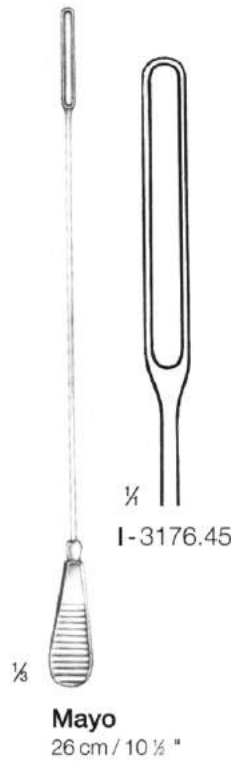
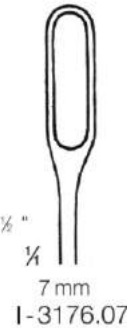
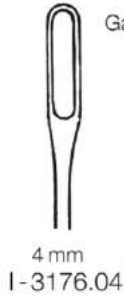

Gall Stone Scoops

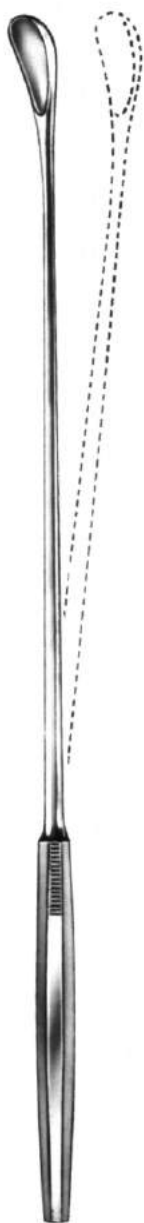

Luer-Körte

32 cm/12 3/4"

malleable, blunt



Fig. 000
I-3230.33
2,5 mm



Fig. 00
I-3230.42
3,2 mm



Fig. 0
I-3230.50
4,2 mm



Fig. 1
I-3230.51
5,5 mm



Fig. 2
I-3230.52
6,7 mm



Fig. 3
I-3230.53
8 mm



Fig. 4
I-3230.54
11 mm



Fig. 5
I-3230.55
15 mm



Mayo

28 cm/11 "

I-3338.28



Moore

30 cm/12 "

I-3355.30

Prostatic Retractors

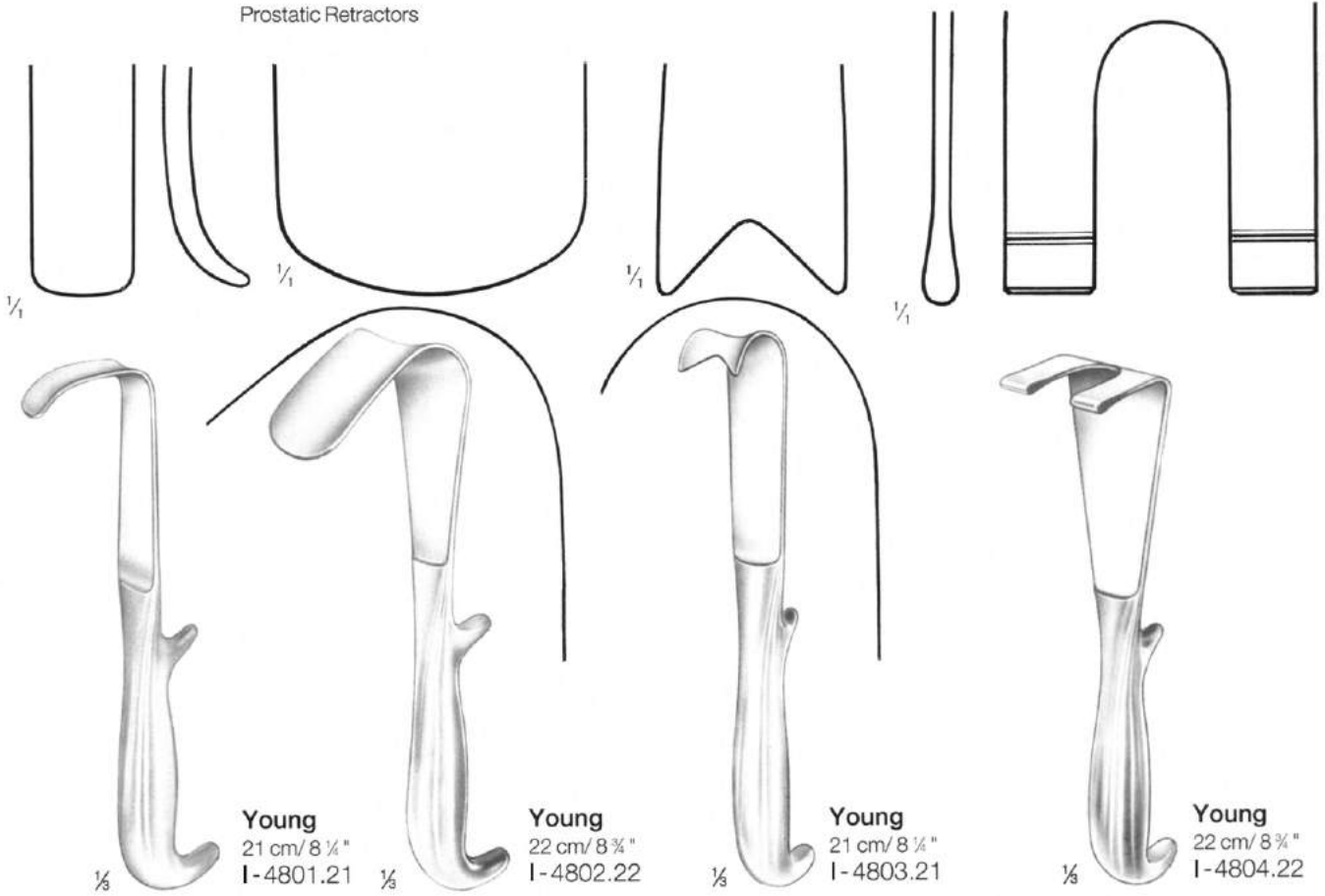

Catheter Introducing Instruments (Guides)

Circumcision instrument

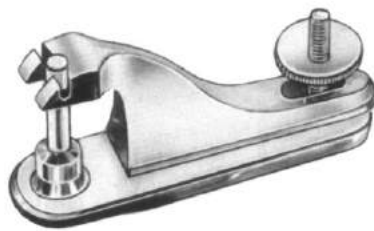

	Ø mm
I-4910.08	8,0
I-4910.11	11,0
I-4910.13	13,0
I-4910.14	14,5
I-4910.16	16,0
I-4910.21	21,0
I-4910.24	24,0
I-4910.26	26,0
I-4910.29	29,0
I-4910.32	32,0
I-4910.35	35,0

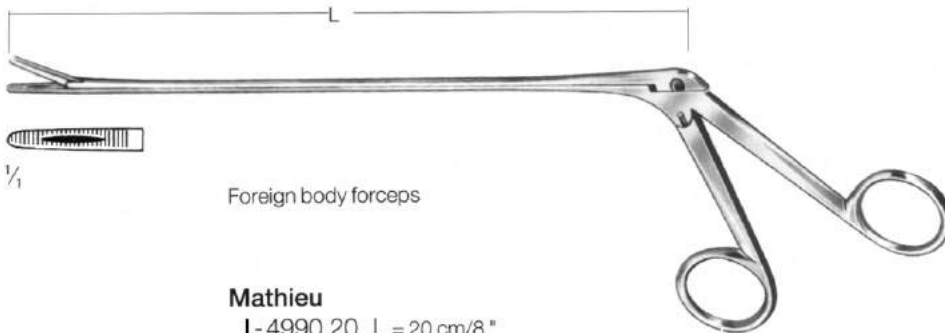

Mathieu
 I-4990.20 L = 20 cm / 8"
 I-4990.28 L = 28 cm / 11"

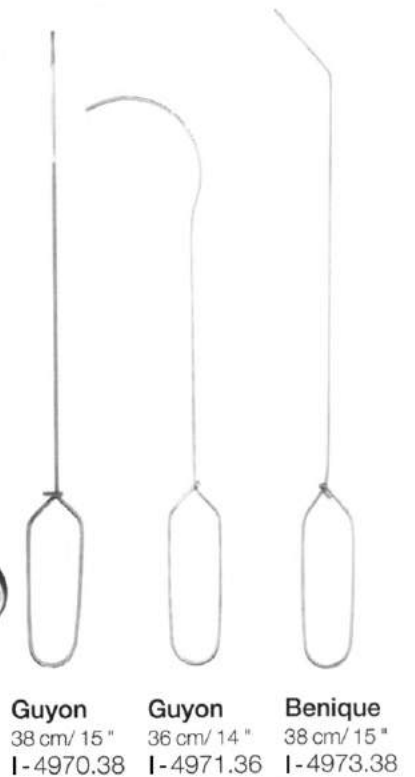



J

- Mallets, chisels, gouges, osteotomes, curettes, rasps, elevators, dissectors
- Maillets, ciseaux-burins, gouges, ostéotomes, curettes tranchantes, limes et râpes à os, rugines, élévateurs, dissecteurs
- Martillos y mazos, cucharillas cortantes, limas para huesos, escofinas, periostótomos, elevadores, disecadores



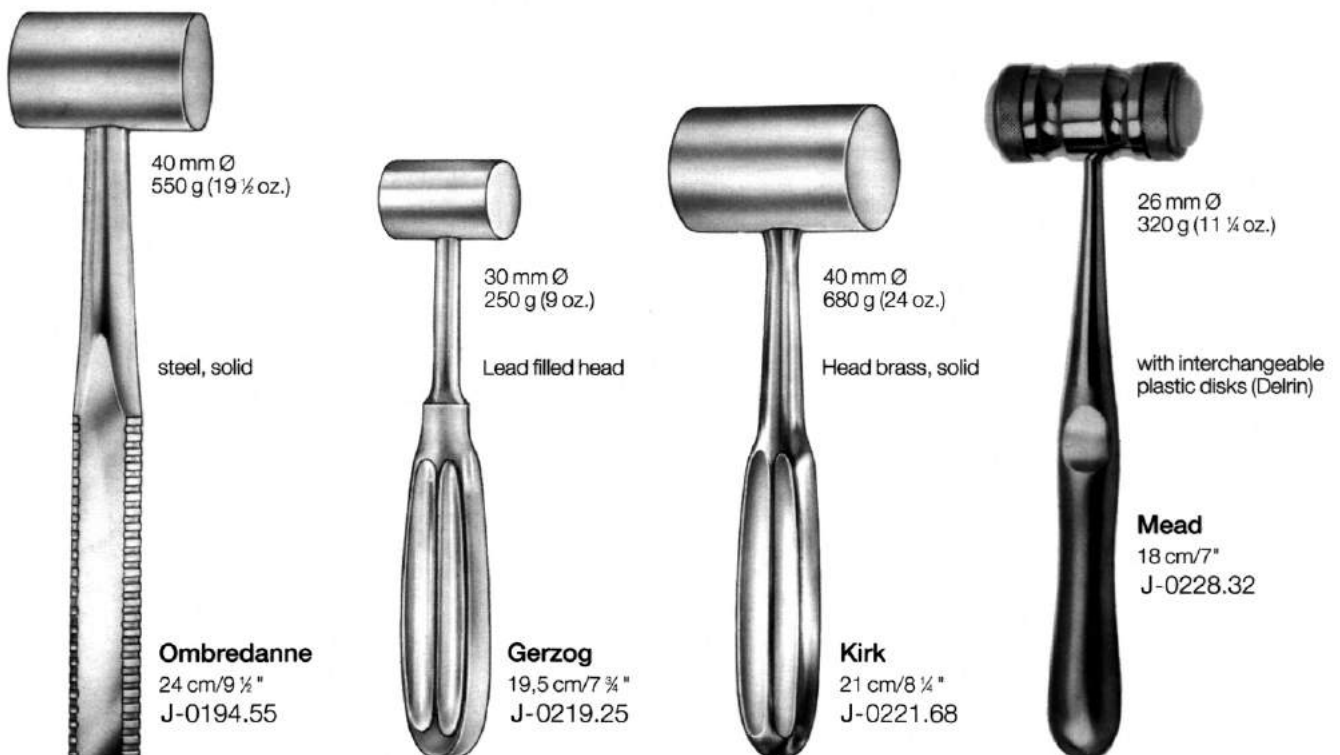
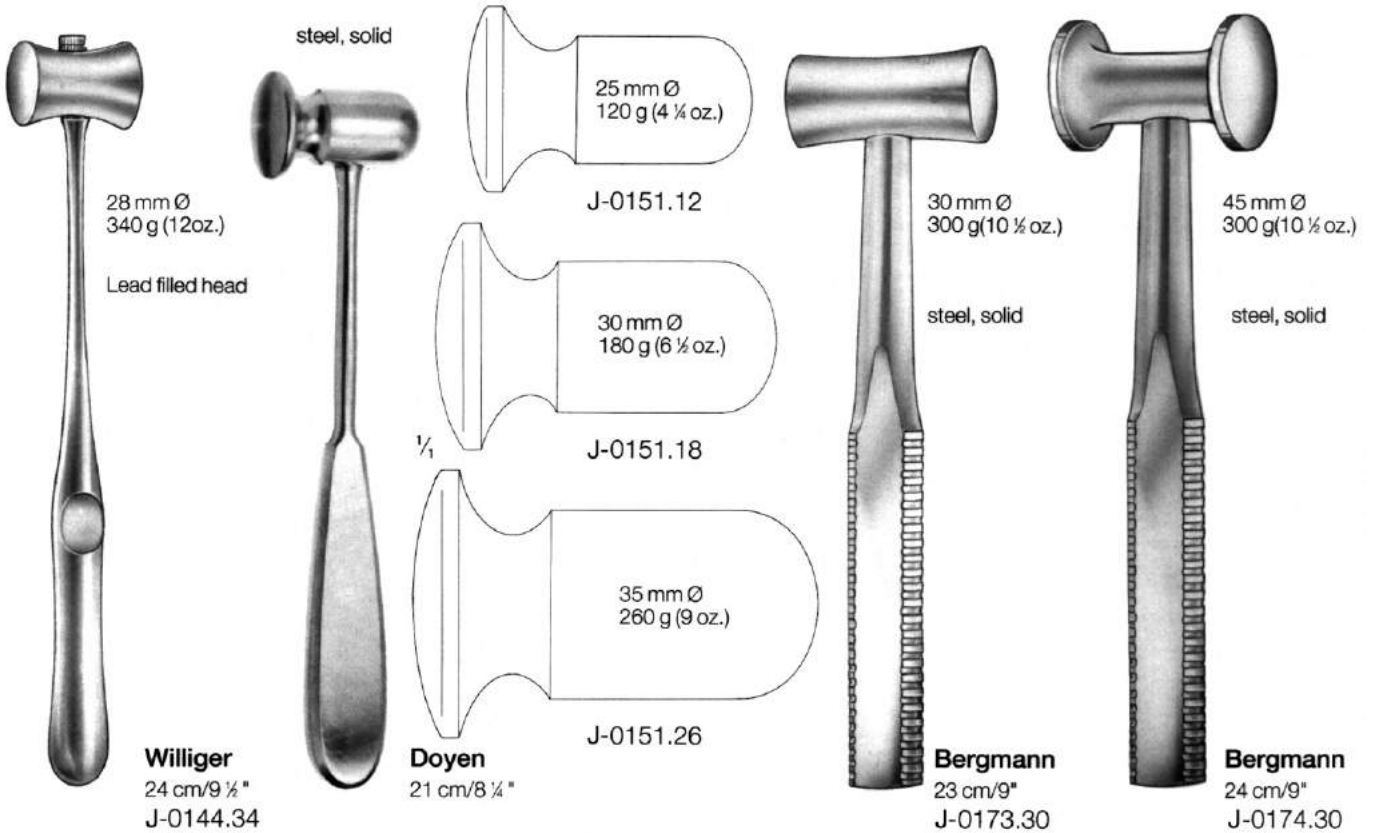



35 mm Ø

Wagner

23 cm/9"

J-0235.13

complete with
1 pair of metal disks
1 pair of plastic disks
(Delrin) and
1 Wrench

½

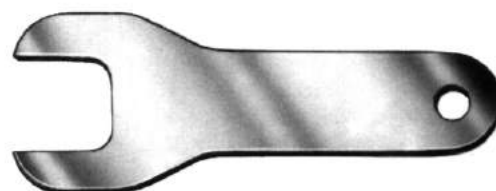

J-0235.99

Wrench



Hemostats, chisels, gouges, osteotomes

Fouloirs hémostatiques, ciseaux-burins, gouges, ostéotomes

Hemostáticos, cineles, gubias, osteótomos

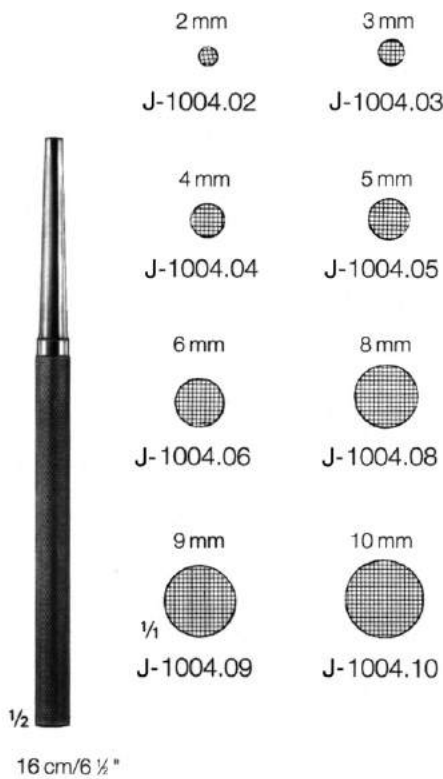
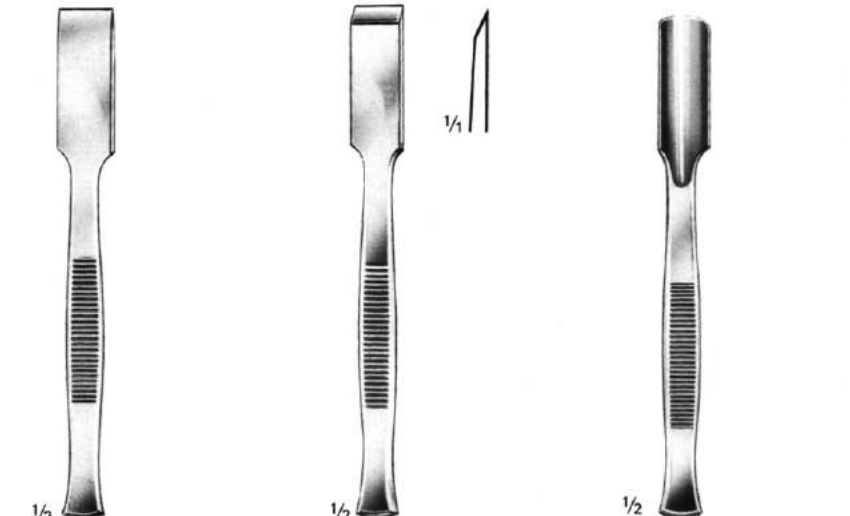

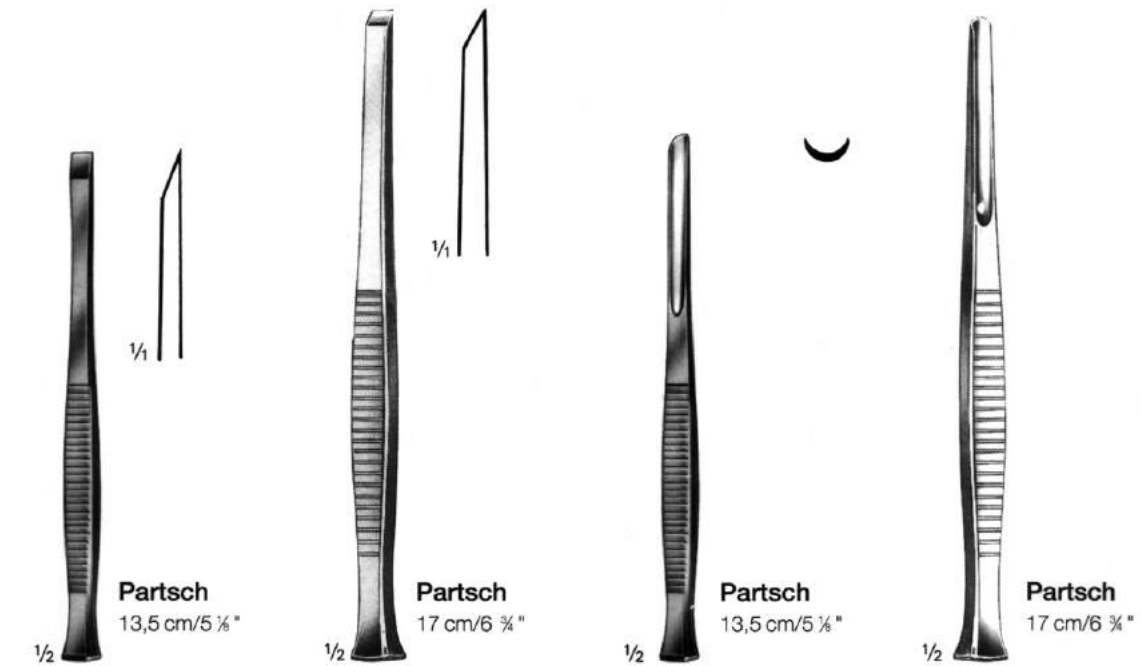

J-1020.04	4 mm	J-1022.04	4 mm	J-1024.04	4 mm
J-1020.06	6 mm	J-1022.06	6 mm	J-1024.06	6 mm
J-1020.08	8 mm	J-1022.08	8 mm	J-1024.08	8 mm
J-1020.10	10 mm	J-1022.10	10 mm	J-1024.10	10 mm
J-1020.12	12 mm	J-1022.12	12 mm	J-1024.12	12 mm
J-1020.14	14 mm	J-1022.14	14 mm	J-1024.14	14 mm
J-1020.16	16 mm	J-1022.16	16 mm	J-1024.16	16 mm

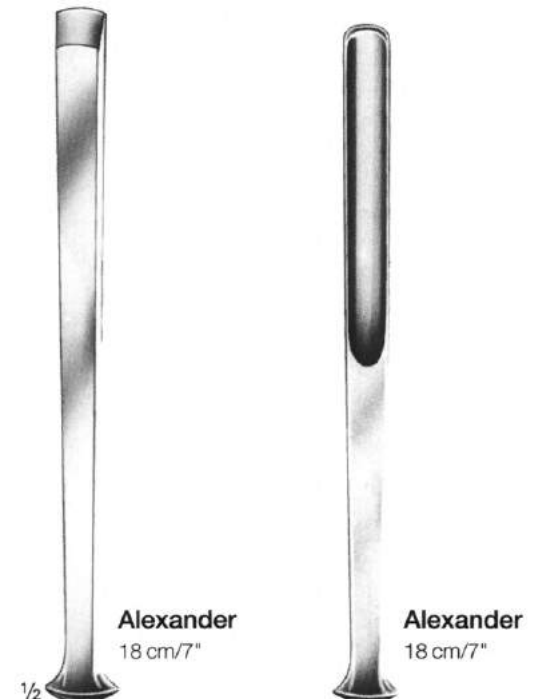

Partsch		Partsch		Partsch		Partsch	
13,5 cm/5 1/2"		17 cm/6 3/4"		13,5 cm/5 1/2"		17 cm/6 3/4"	
J-1062.02	2 mm	J-1072.02	2 mm	J-1064.02	2 mm	J-1074.02	2 mm
J-1062.03	3 mm	J-1072.03	3 mm	J-1064.03	3 mm	J-1074.03	3 mm
J-1062.04	4 mm	J-1072.04	4 mm	J-1064.04	4 mm	J-1074.04	4 mm
J-1062.05	5 mm	J-1072.05	5 mm	J-1064.05	5 mm	J-1074.05	5 mm
J-1062.06	6 mm	J-1072.06	6 mm	J-1064.06	6 mm	J-1074.06	6 mm
J-1062.07	7 mm	J-1072.07	7 mm	J-1064.07	7 mm	J-1074.07	7 mm
J-1062.08	8 mm	J-1072.08	8 mm	J-1064.08	8 mm	J-1074.08	8 mm

Osteotomes, chisels, gouges
Ostéotomes, ciseaux-burins, gouges
Osteótomos, cinceles, gubias



Alexander
18 cm/7"

J-1112.04	4 mm	J-1114.04	4 mm
J-1112.06	6 mm	J-1114.06	6 mm
J-1112.08	8 mm	J-1114.08	8 mm
J-1112.10	10 mm	J-1114.10	10 mm
J-1112.12	12 mm	J-1114.12	12 mm
J-1112.14	14 mm	J-1114.14	14 mm

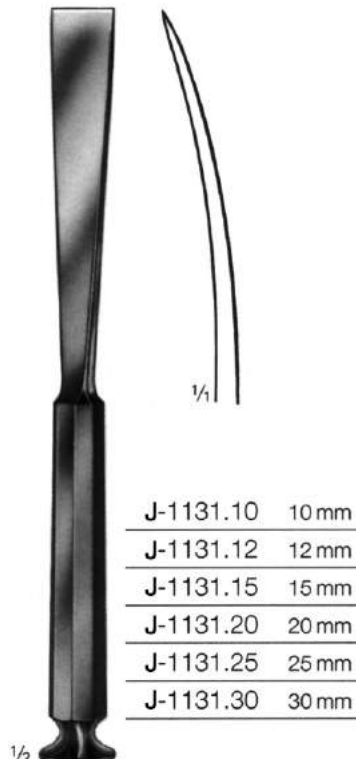

Stille
20 cm/8"

J-1131.10	10 mm
J-1131.12	12 mm
J-1131.15	15 mm
J-1131.20	20 mm
J-1131.25	25 mm
J-1131.30	30 mm

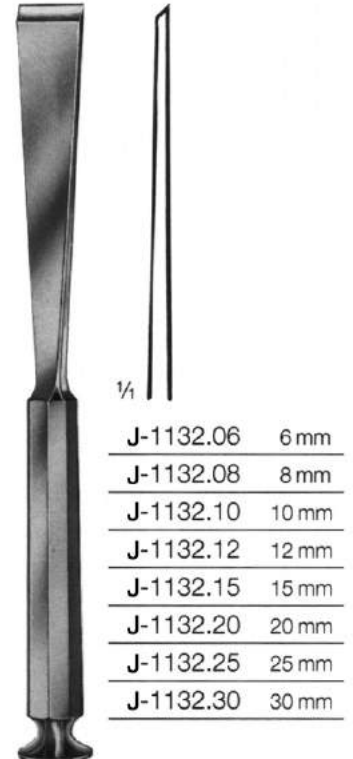

Stille
20 cm/8"

J-1132.06	6 mm
J-1132.08	8 mm
J-1132.10	10 mm
J-1132.12	12 mm
J-1132.15	15 mm
J-1132.20	20 mm
J-1132.25	25 mm
J-1132.30	30 mm

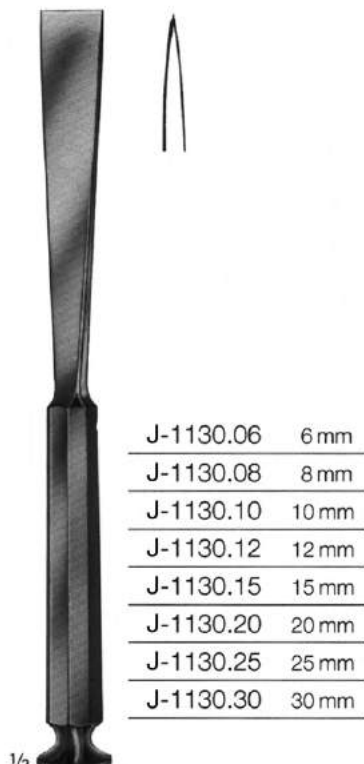

Stille
20 cm/8"

J-1130.06	6 mm
J-1130.08	8 mm
J-1130.10	10 mm
J-1130.12	12 mm
J-1130.15	15 mm
J-1130.20	20 mm
J-1130.25	25 mm
J-1130.30	30 mm

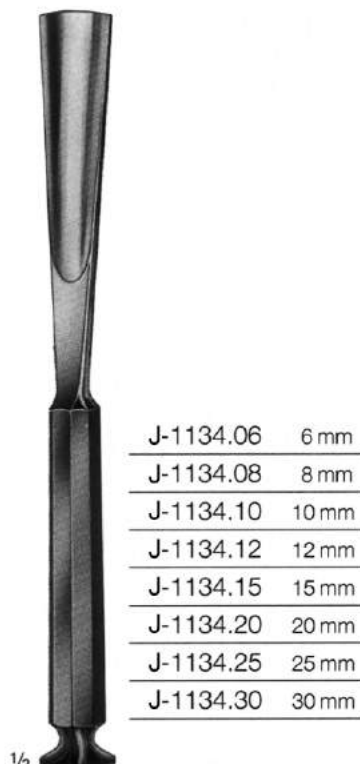

Stille
20 cm/8"

J-1134.06	6 mm
J-1134.08	8 mm
J-1134.10	10 mm
J-1134.12	12 mm
J-1134.15	15 mm
J-1134.20	20 mm
J-1134.25	25 mm
J-1134.30	30 mm

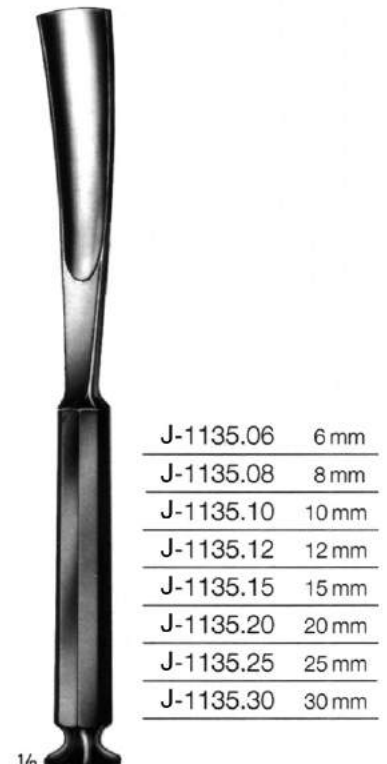

Stille
20 cm/8"

J-1135.06	6 mm
J-1135.08	8 mm
J-1135.10	10 mm
J-1135.12	12 mm
J-1135.15	15 mm
J-1135.20	20 mm
J-1135.25	25 mm
J-1135.30	30 mm

Chisels, gouges, with ferrozell (novotex) handles
Ciseaux-burins, gouges, manche en ferrozell (novottex)
Cinceles, gubias, con mangos de ferrozell (novotex)



1/2

1/4

4 mm
J-1150.04

6 mm
J-1150.06

8 mm
J-1150.08

10 mm
J-1150.10

12 mm
J-1150.12

Mini-Lexer
18 cm/7"



1/2

1/4

4 mm
J-1154.04

6 mm
J-1154.06

8 mm
J-1154.08

10 mm
J-1154.10

12 mm
J-1154.12

Mini-Lexer
18 cm/7"



1/2

1/4

7 mm

10 mm

15 mm

20 mm

25 mm

30 mm

1/4

J-1160.07	7 mm
J-1160.10	10 mm
J-1160.15	15 mm
J-1160.20	20 mm
J-1160.25	25 mm
J-1160.30	30 mm

Lexer
22 cm/8 3/4"



1/2

1/4

7 mm

10 mm

15 mm

20 mm

25 mm

30 mm

1/4

J-1164.07	7 mm
J-1164.10	10 mm
J-1164.15	15 mm
J-1164.20	20 mm
J-1164.25	25 mm
J-1164.30	30 mm

Lexer
22 cm/8 3/4"

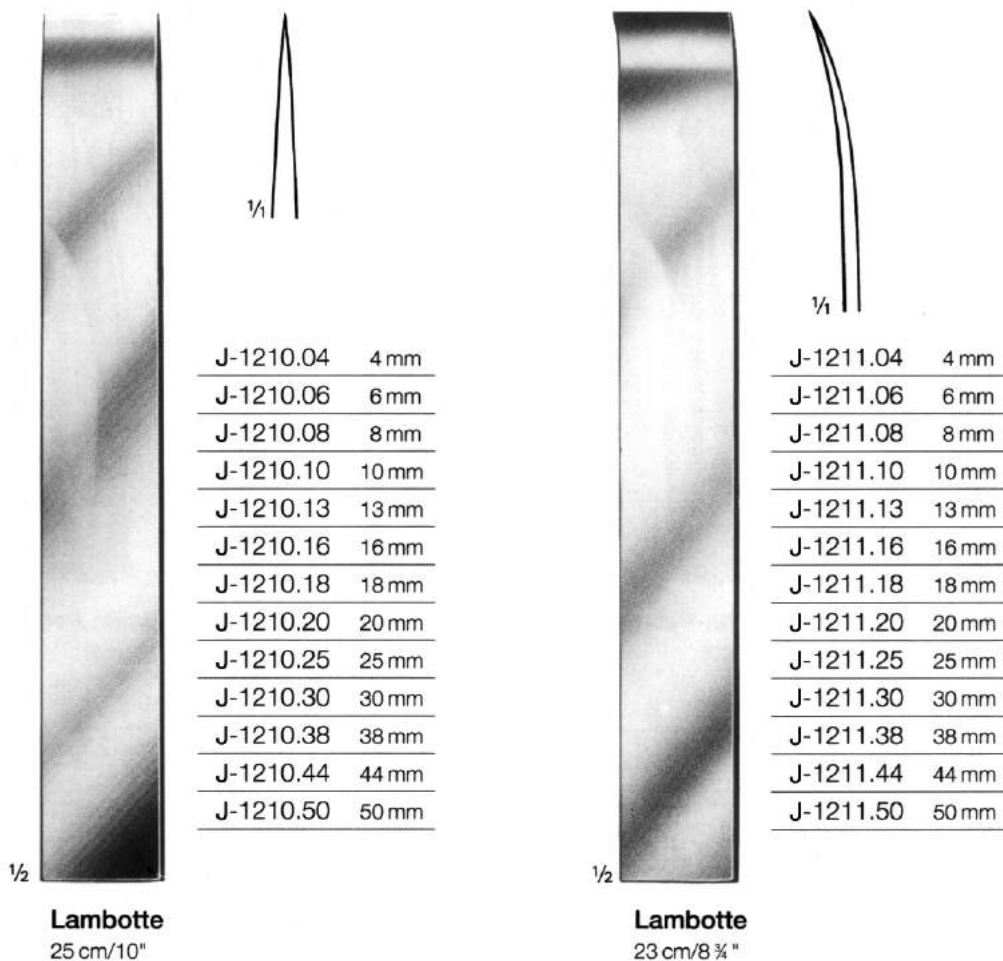
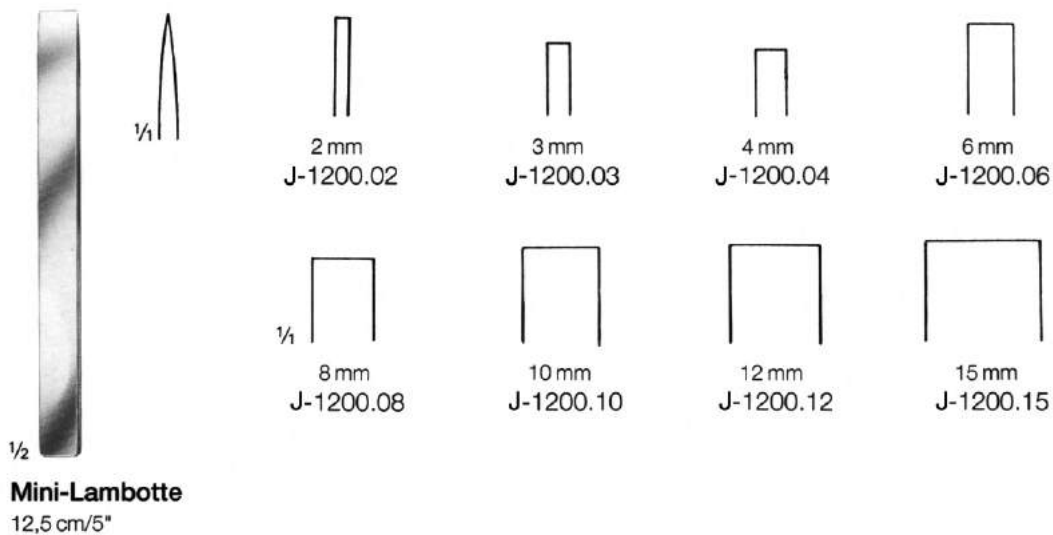



1/2

Smith-Petersen
20 cm/8"



1/2

Smith-Petersen
20 cm/8"



1/2

Smith-Petersen
20 cm/8"



1/2

Smith-Petersen
20 cm/8"

6 mm	J-1230.06	J-1231.06	-	-
9 mm	J-1230.09	J-1231.09	J-1234.09	J-1235.09
13 mm	J-1230.13	J-1231.13	-	-
14 mm	-	-	J-1234.14	J-1235.14
16 mm	J-1230.16	J-1231.16	-	-
19 mm	J-1230.19	J-1231.19	J-1234.19	J-1235.19
25 mm	J-1230.25	J-1231.25	J-1234.25	J-1235.25
32 mm	J-1230.32	J-1231.32	J-1234.32	J-1235.32



Hibbs
24 cm/9 1/2"

Hibbs
24 cm/9 1/2"

Hibbs
24 cm/9 1/2"

Hibbs
24 cm/9 1/2"

Hibbs
24 cm/9 1/2"

6 mm	J-1250.06	J-1252.06	J-1251.06	J-1254.06	J-1255.06
13 mm	J-1250.13	J-1252.13	J-1251.13	J-1254.13	J-1255.13
19 mm	J-1250.19	J-1252.19	J-1251.19	J-1254.19	J-1255.19
25 mm	J-1250.25	J-1252.25	J-1251.25	J-1254.25	J-1255.25
32 mm	J-1250.32	J-1252.32	J-1251.32	J-1254.32	J-1255.32

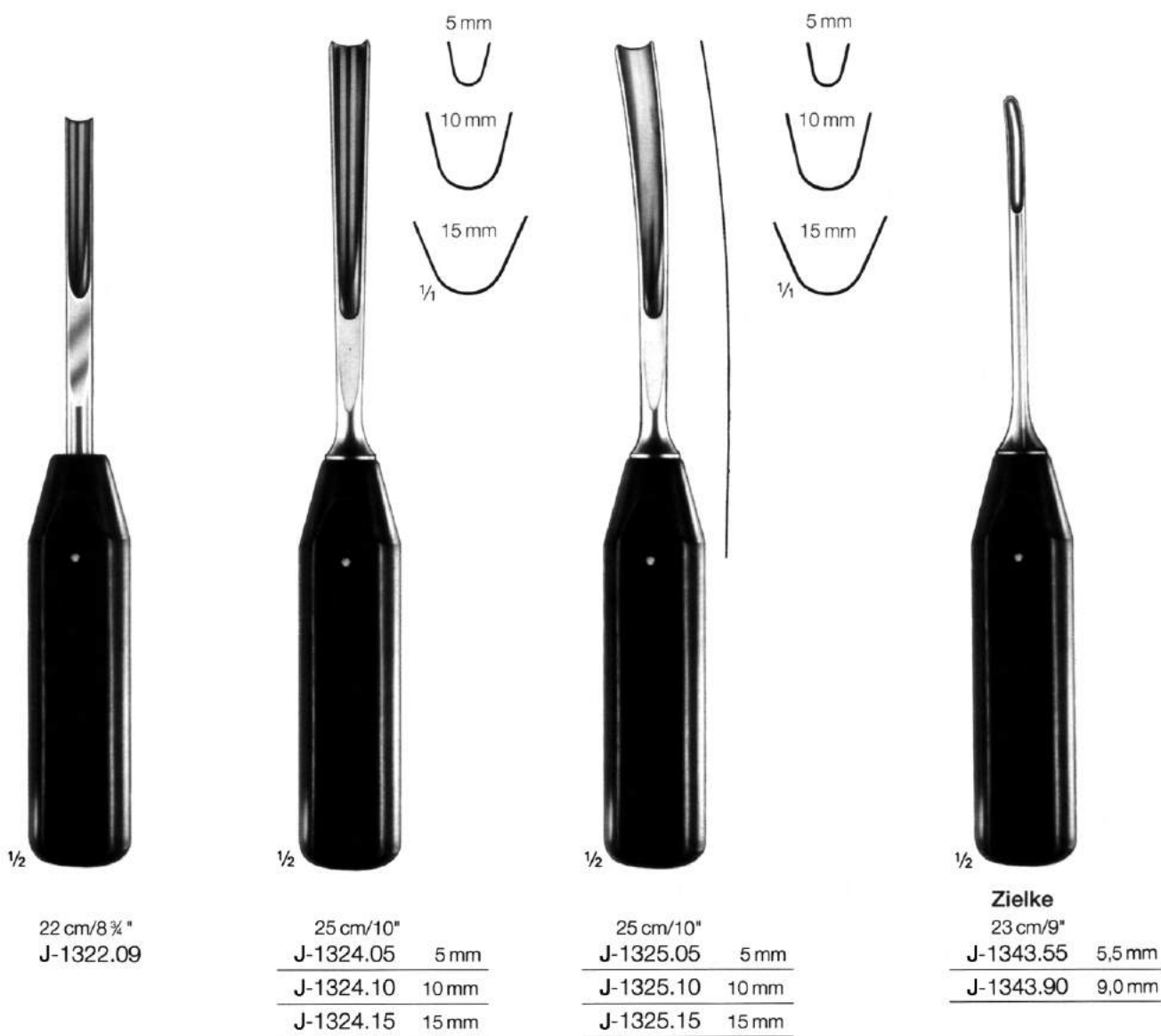



Cobb
28 cm/11"
J-1358.08



Cobb
28 cm/11"
J-1358.28



Cobb
28 cm/11"
J-1358.48



Cobb
28 cm/11"
J-1358.68

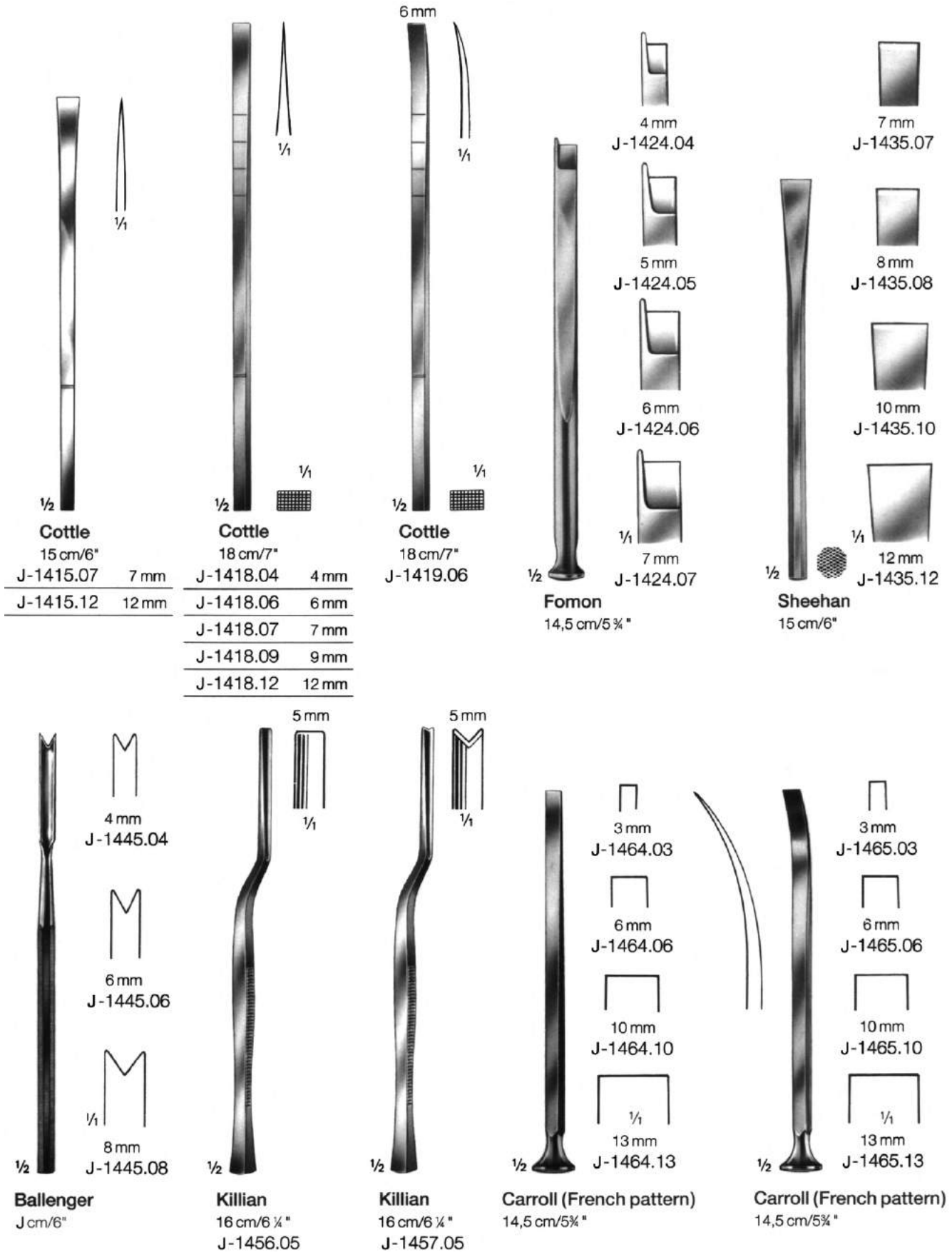

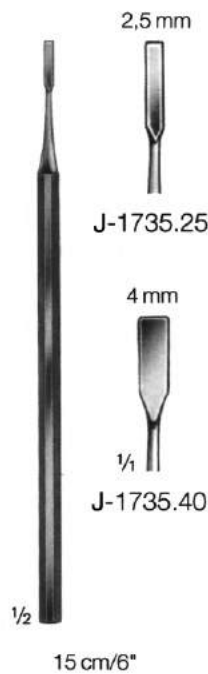
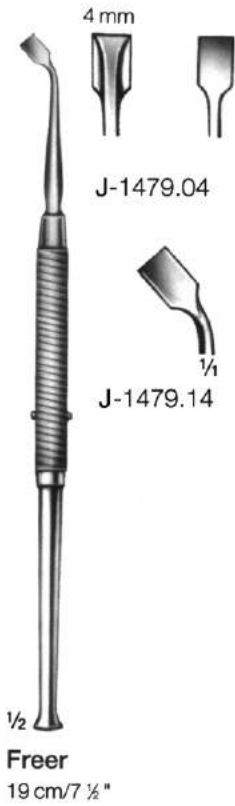

for sectioning of
 Alveolar Process
 between two roots



Dissecting Chisels

for opening the spinal column



Skull Breaker

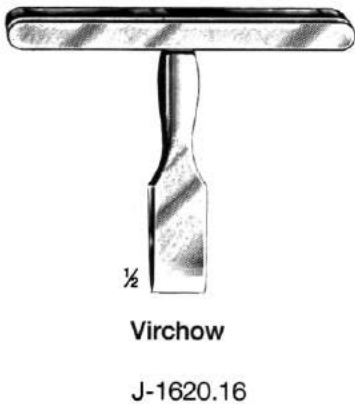

Sternum Chisel



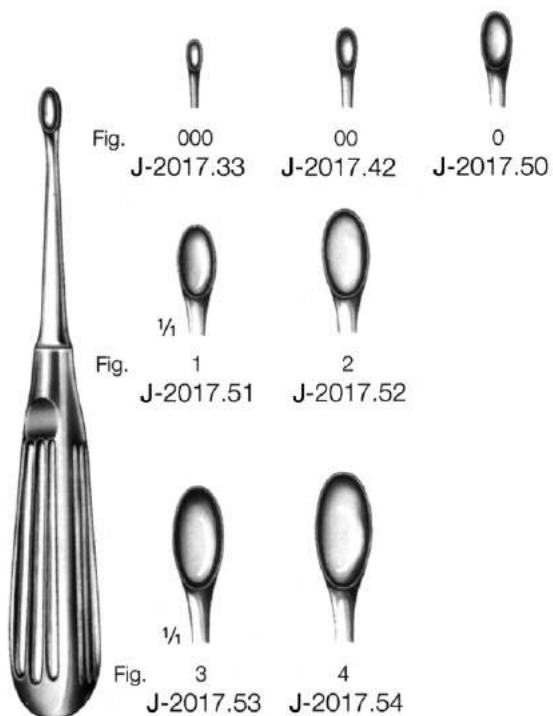

Schede
 17 cm/6 3/4"



Volkmann
 17 cm/6 3/4"

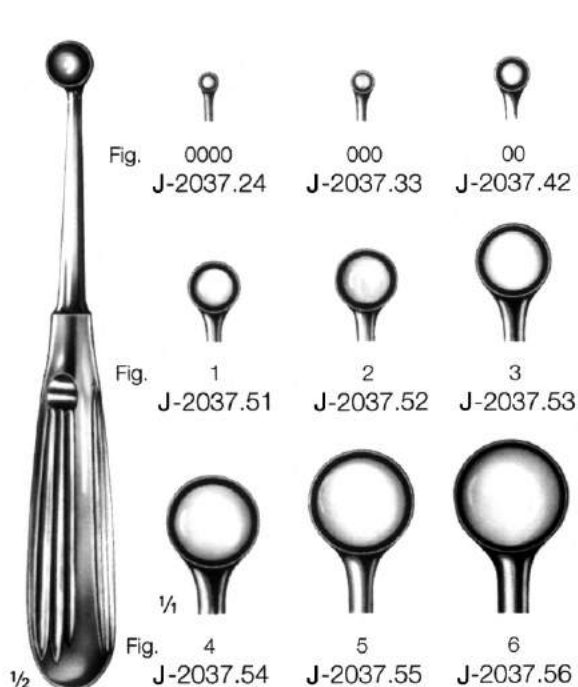

Bruns
 17 cm/6 3/4"

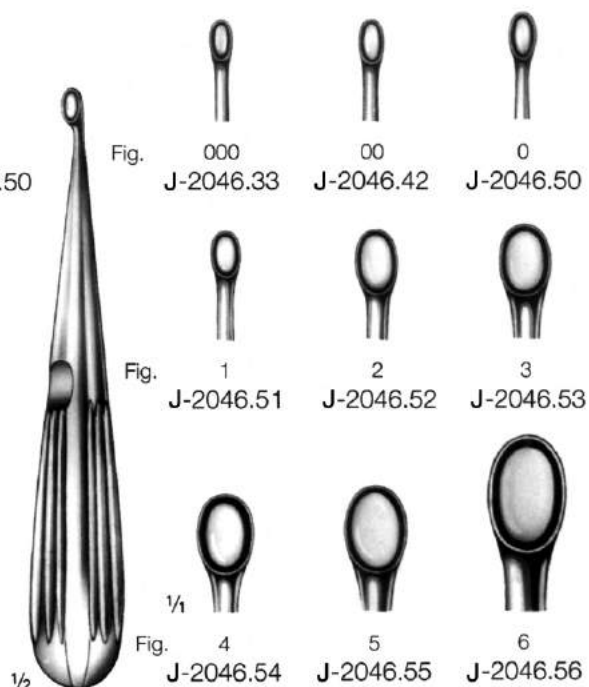

Spratt
 16 cm/6 1/4"



1/2
Epstein
 20 cm / 8"



1/2
Hibbs-Spratt
 (Spinal-Fusion)
 20 cm / 8"



1/2
Hibbs-Spratt
 (Spinal-Fusion)
 20 cm / 8"

J-2060.33	Fig. 000	J-2070.33	Fig. 000	J-2081.33	Fig. 000
J-2060.42	Fig. 00	J-2070.42	Fig. 00	J-2081.42	Fig. 00
J-2060.50	Fig. 0	J-2070.50	Fig. 0	J-2081.50	Fig. 0
		J-2070.51	Fig. 1	J-2081.51	Fig. 1
		J-2070.52	Fig. 2	J-2081.52	Fig. 2
		J-2070.53	Fig. 3	J-2081.53	Fig. 3
		J-2070.54	Fig. 4	J-2081.54	Fig. 4
		J-2070.55	Fig. 5	J-2081.55	Fig. 5
		J-2070.56	Fig. 6	J-2081.56	Fig. 6

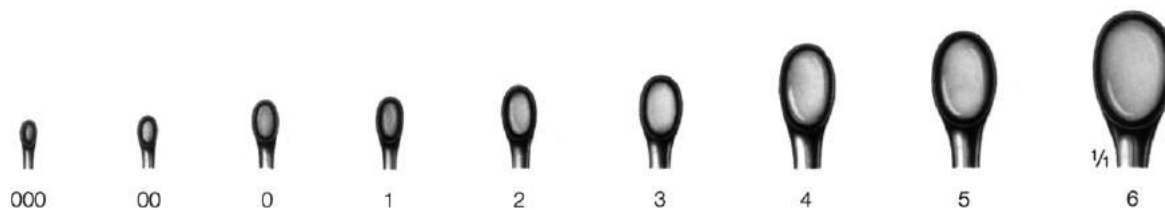

Bruns
23 cm/9"



Bruns
23 cm/9"



Bruns
23 cm/9"

J-2092.33	Fig. 000	J-2093.33	Fig. 000	J-2096.33	Fig. 000
J-2092.42	Fig. 00	J-2093.42	Fig. 00	J-2096.42	Fig. 00
J-2092.50	Fig. 0	J-2093.50	Fig. 0	J-2096.50	Fig. 0
J-2092.51	Fig. 1	J-2093.51	Fig. 1	J-2096.51	Fig. 1
J-2092.52	Fig. 2	J-2093.52	Fig. 2	J-2096.52	Fig. 2
J-2092.53	Fig. 3	J-2093.53	Fig. 3	J-2096.53	Fig. 3
J-2092.54	Fig. 4	J-2093.54	Fig. 4	J-2096.54	Fig. 4
J-2092.55	Fig. 5	J-2093.55	Fig. 5	J-2096.55	Fig. 5
J-2092.56	Fig. 6	J-2093.56	Fig. 6	J-2096.56	Fig. 6

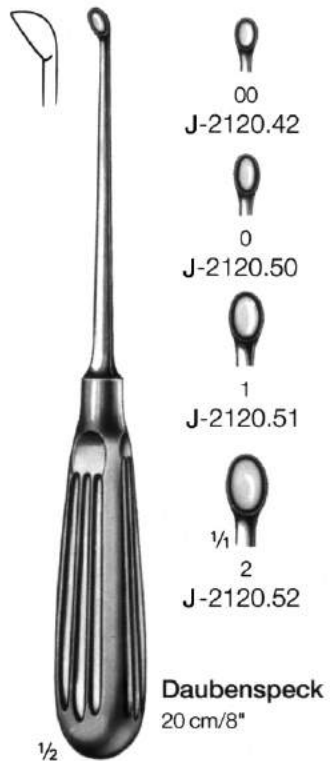
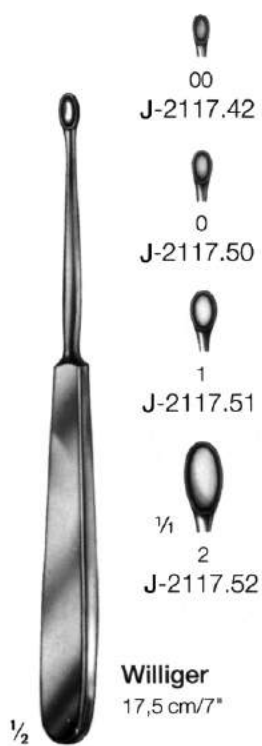

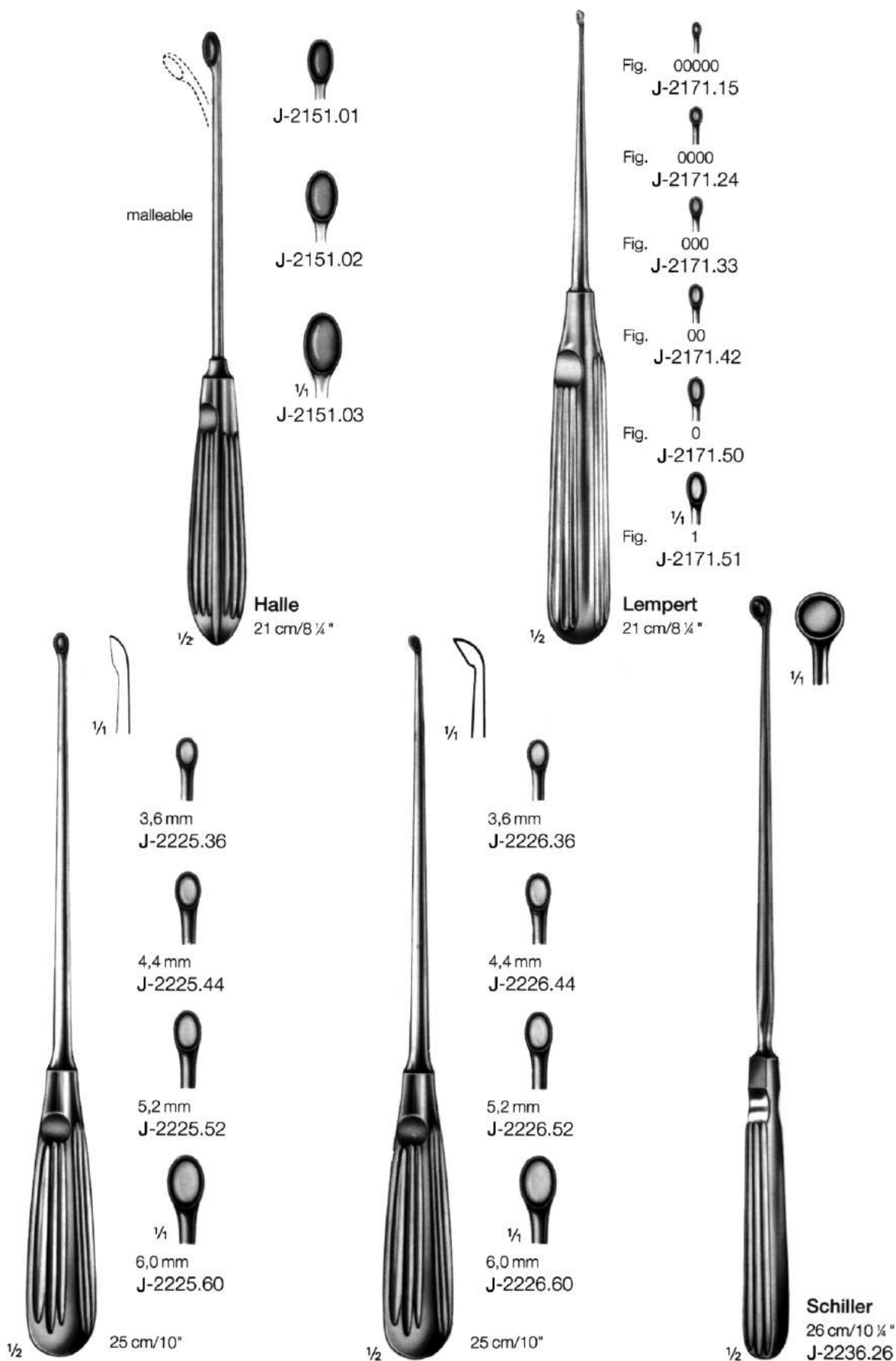

Lupus Curettes

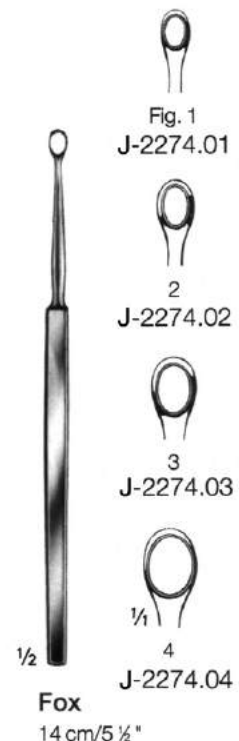
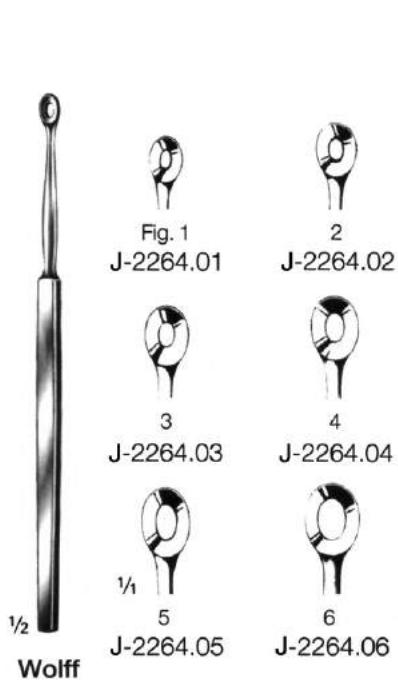
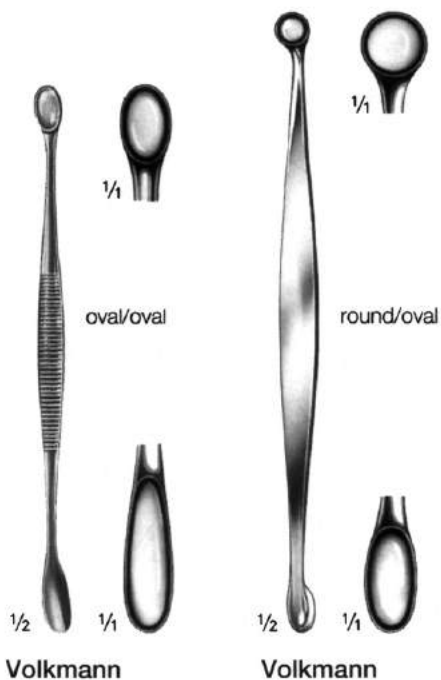

cm	inch		
13	5	J-2310.13	J-2314.13
14.5	5 1/2	J-2310.14	
16	6 1/4		J-2314.16
17	6 3/4	J-2310.17	
20	8	J-2310.20	J-2314.20

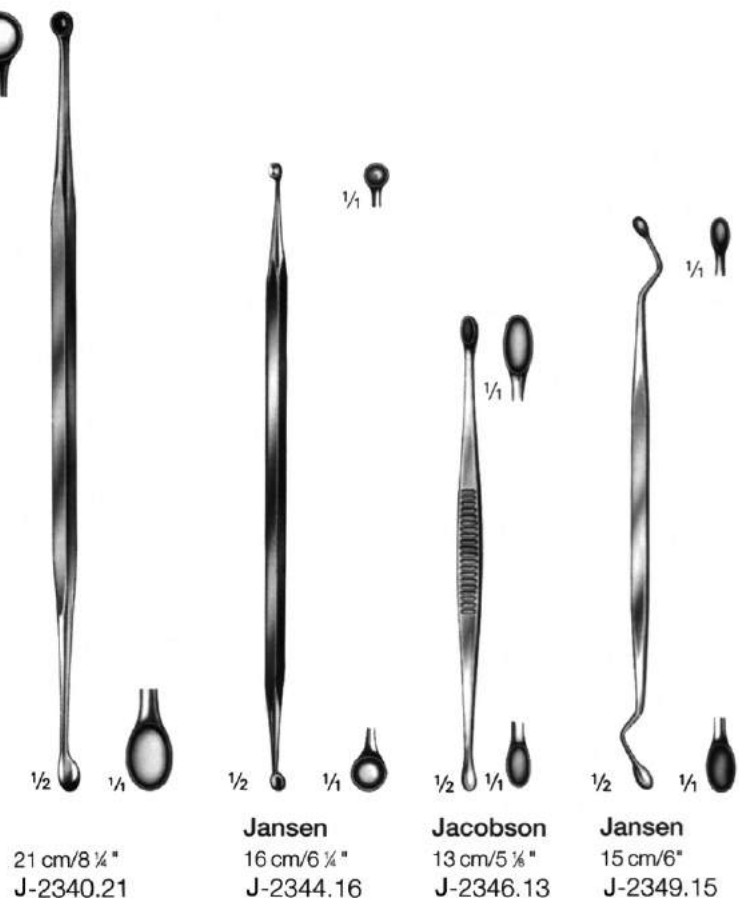
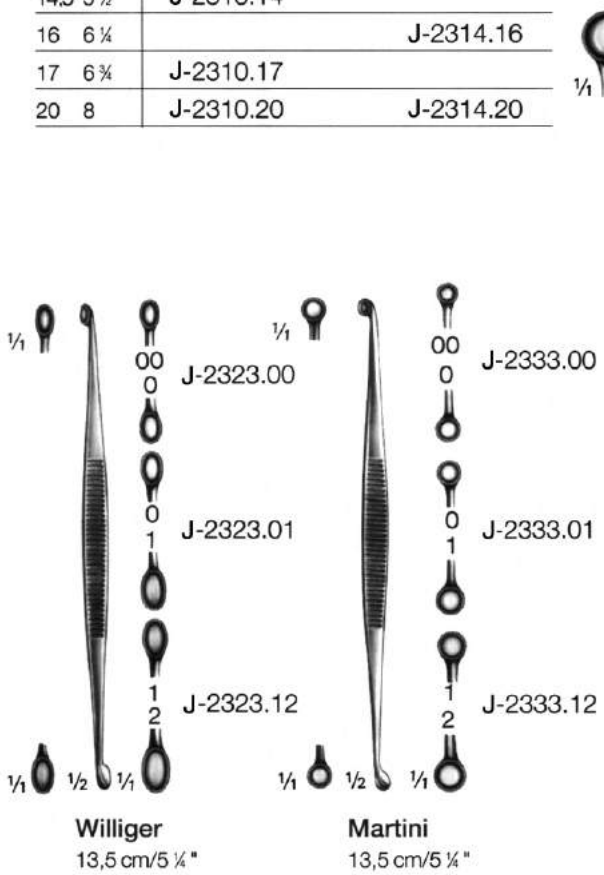

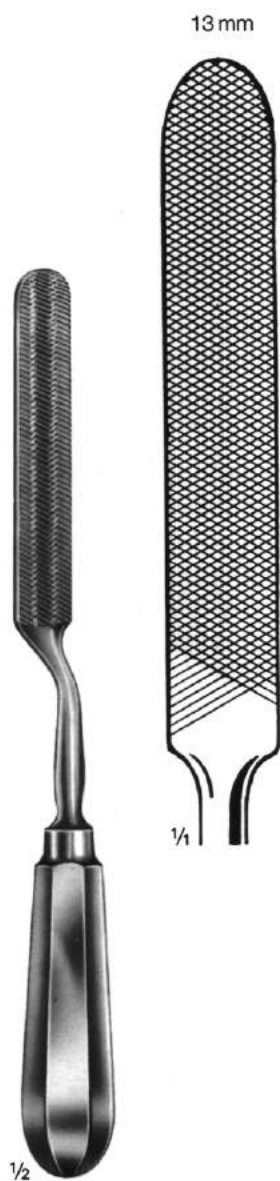

24 cm/9 1/2"
 J-2513.24



Putti
 30 cm/12"
 J-2517.30



Putti
 27 cm/10 1/2"
 J-2521.27

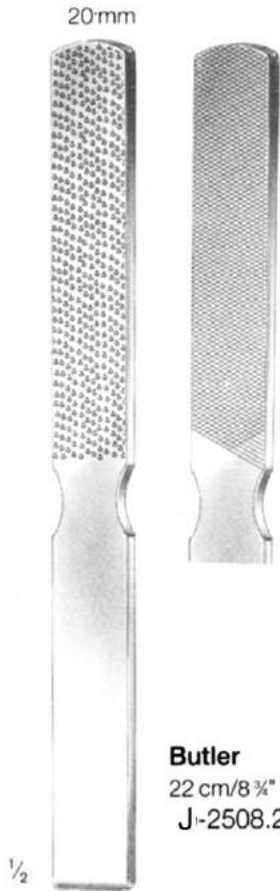

Butler
 22 cm/8 3/4"
 J-2508.22

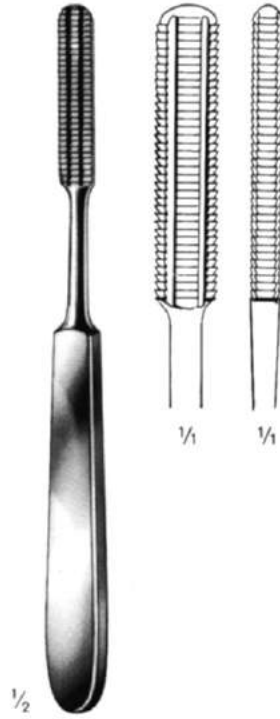

Maltz
 18 cm/7"
 J-2602.18

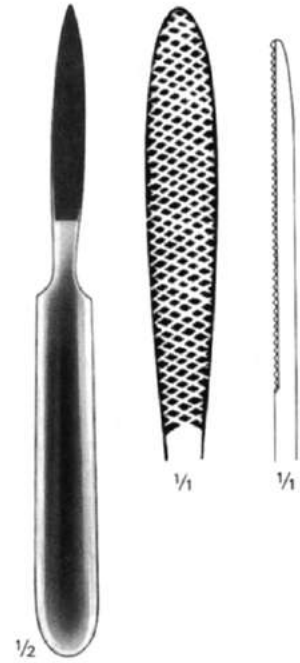

Joseph
 16 cm/6 1/4"
 J-2616.01

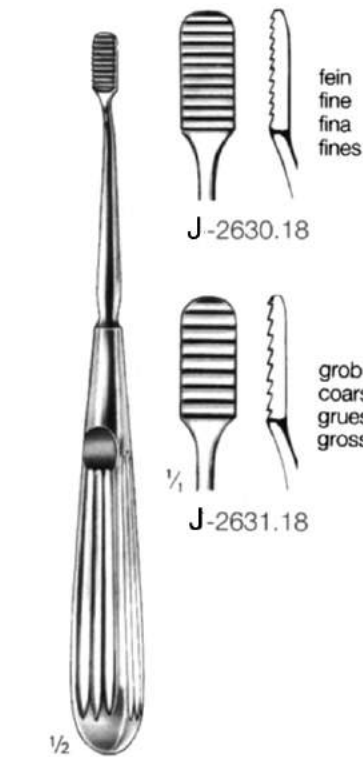

J-2630.18



J-2631.18

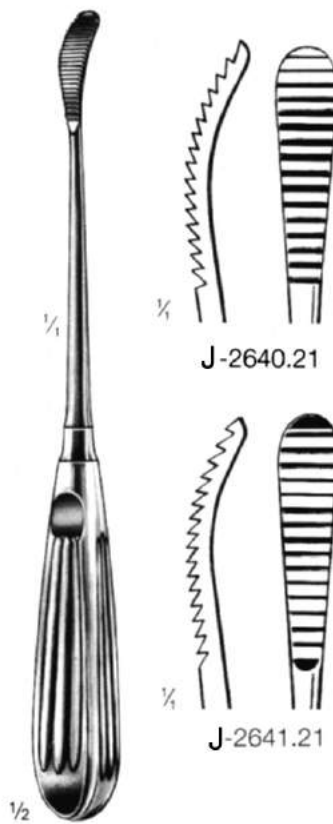

Aufricht
 21 cm/8 1/4"

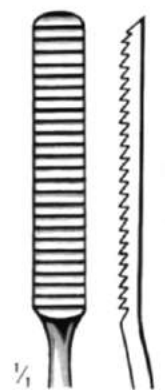

Cottle
 21 cm/8 1/4"
 J-2646.21

12,5 mm

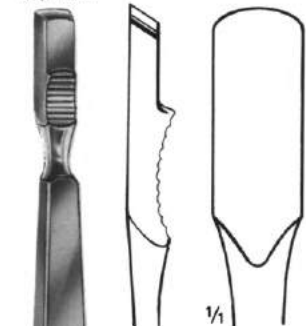

1/2

Farabeuf
15 cm/6"
J-3010.15

12,5 mm

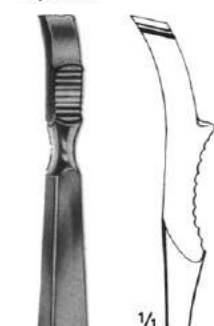

1/2

Farabeuf
15 cm/6"
J-3011.15

11 mm



1/2

Farabeuf-Collin
15,5 cm/6 1/8"
J-3012.15

11 mm

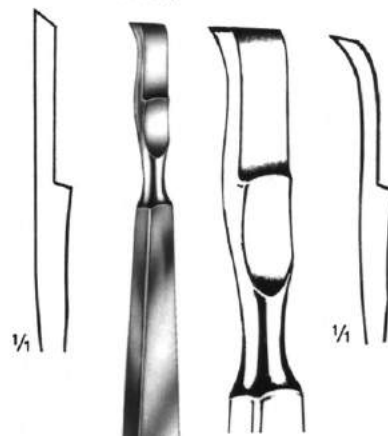

1/2

Farabeuf-Collin
15,5 cm/6 1/8"
J-3013.15

14 mm



1/2

Langenbeck
18 cm/7"
J-3021.18

16 mm



1/2

Langenbeck
19 cm/7 1/2"
J-3022.19

15 mm



1/2

Cushing
19 cm/7 1/2"
J-3025.19

1/4



1/2

Lambotte
21 cm/8 1/4"

J-3031.05	5 mm
J-3031.10	10 mm
J-3031.15	15 mm
J-3031.20	20 mm
J-3031.25	25 mm

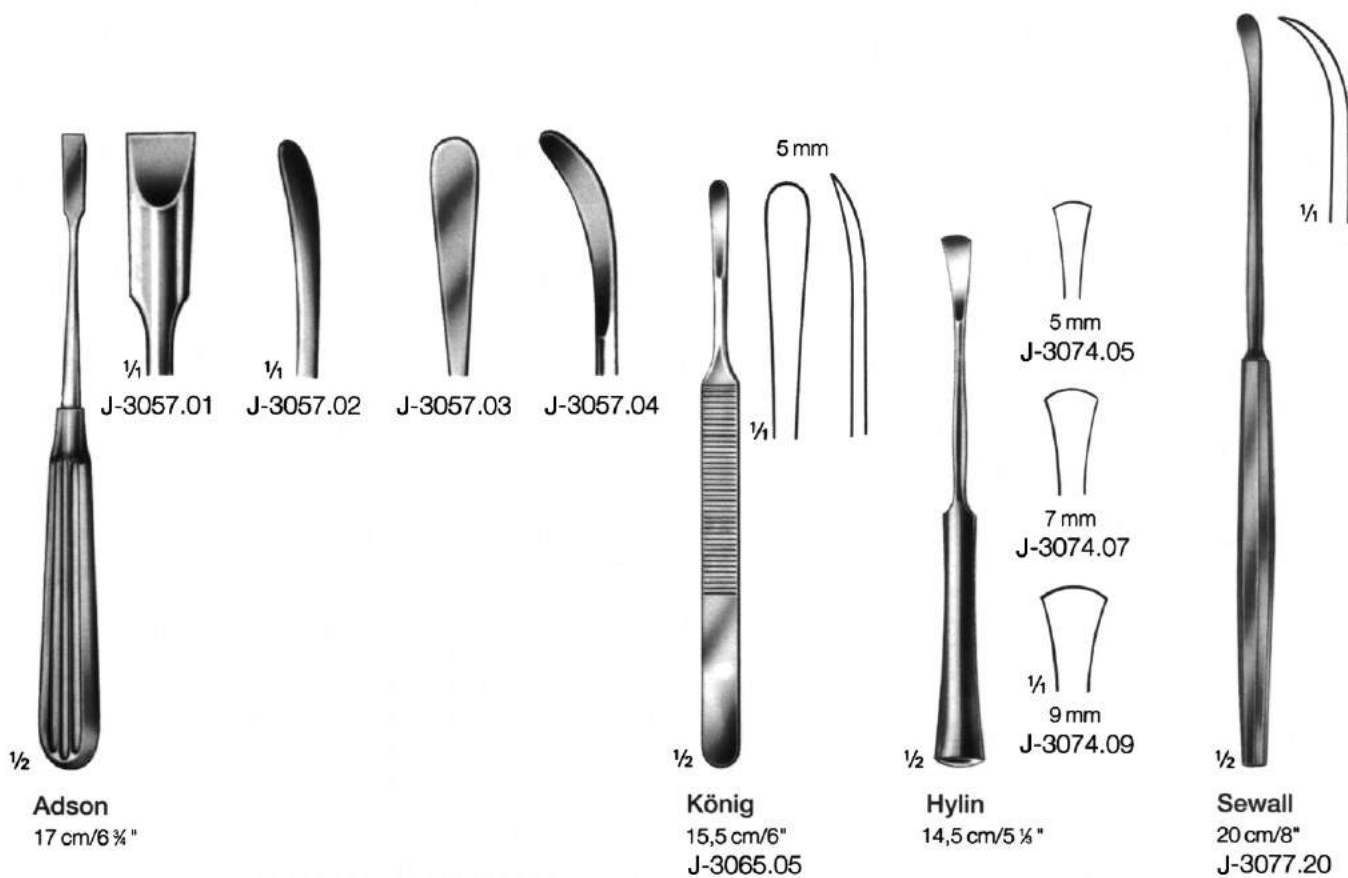
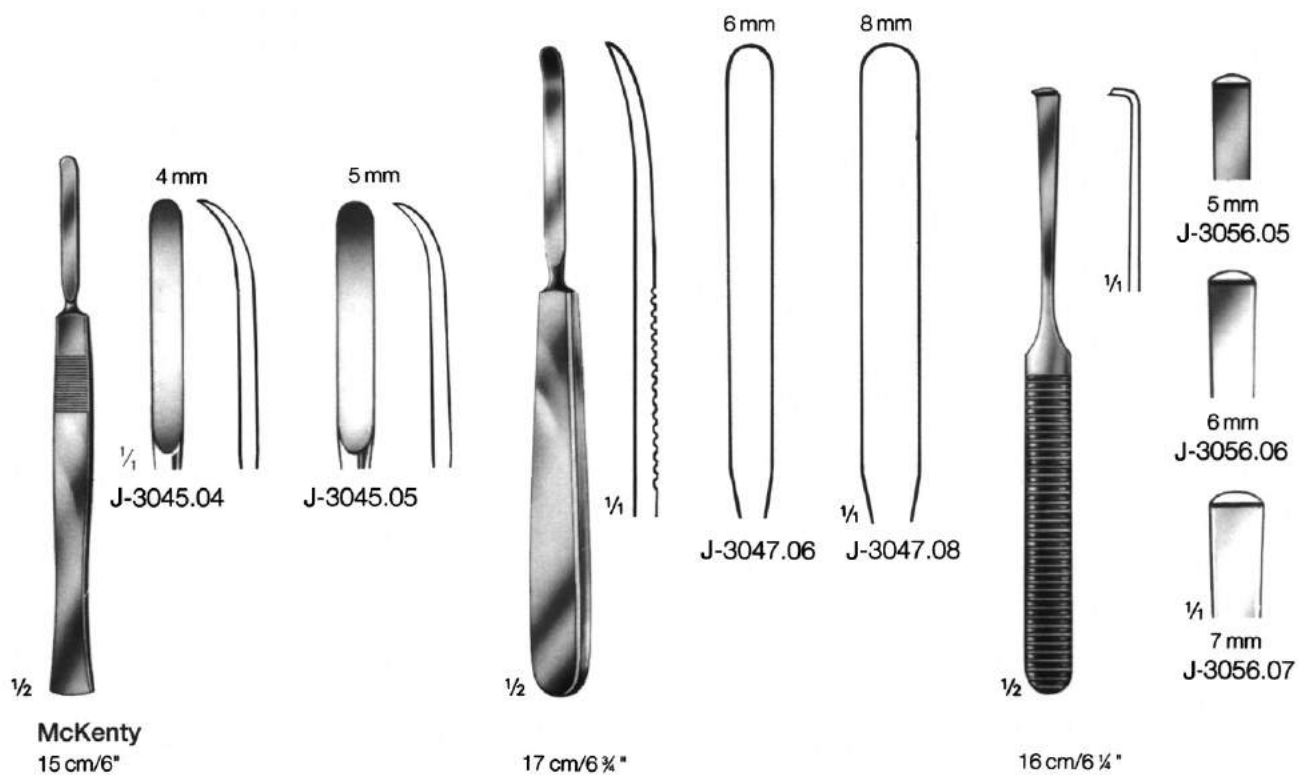

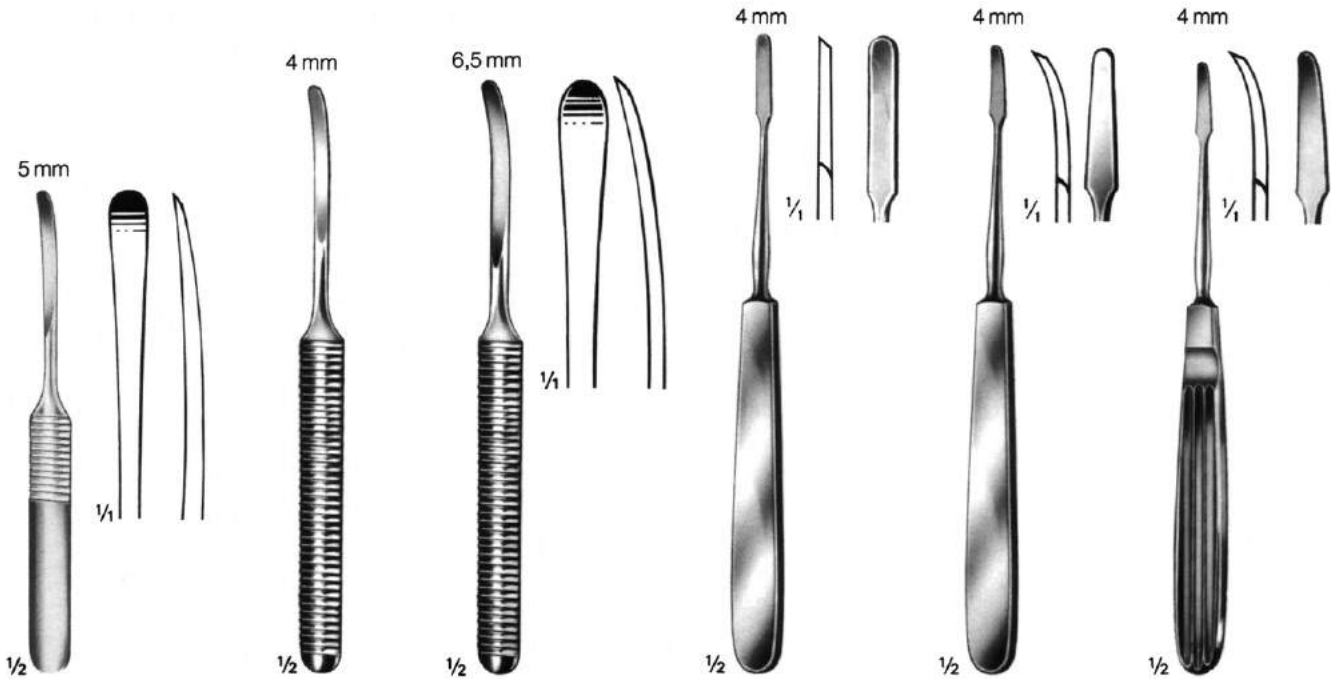

Williger
13 cm/5"
J-3113.05

Williger
16 cm/6 1/4"
J-3116.40

Williger
16 cm/6 1/4"
J-3116.65

Fomon
17 cm/6 3/4"
J-3127.04

Joseph
16 cm/6 1/4"
J-3136.04

Joseph
16 cm/6 1/4"
J-3137.04

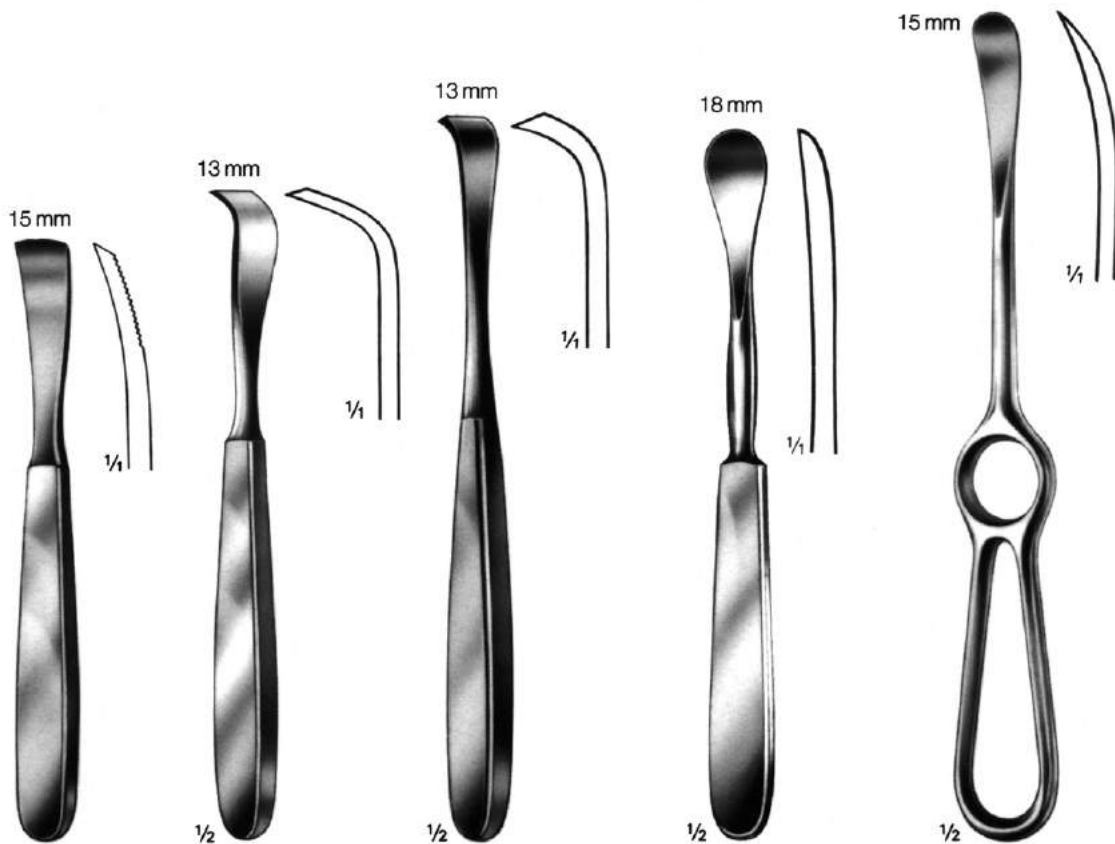

Jansen
16,5 cm/6 1/2"
J-3146.15

Schneider
17,5 cm/7"
J-3157.13

Schneider-Sauerbruch
19 cm/7 1/2"
J-3159.13

Sedillot
18 cm/7"
J-3168.18

Sedillot
21 cm/8 1/4"
J-3171.15

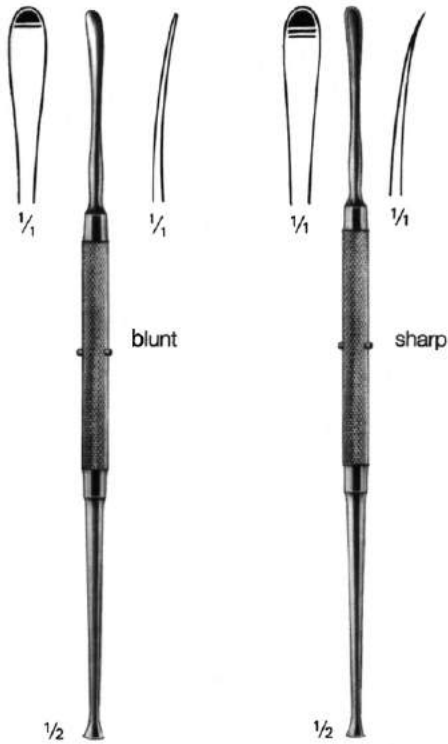

Freer
 19 cm/7 1/2"
 J-3179.01



Freer
 19 cm/7 1/2"
 J-3179.02



Freer
 17 cm/6 3/4"
 J-3179.17

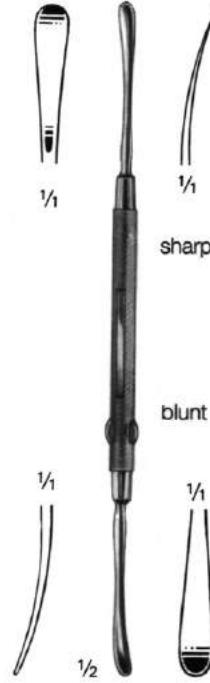

Freer
 18 cm/7"
 J-3180.18



Freer
 20 cm/8"
 J-3180.20

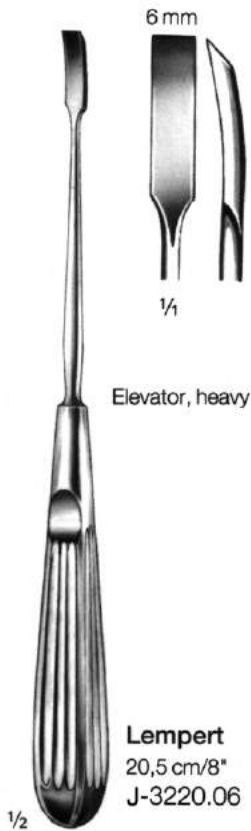

Lempert
 20,5 cm/8"
 J-3220.06

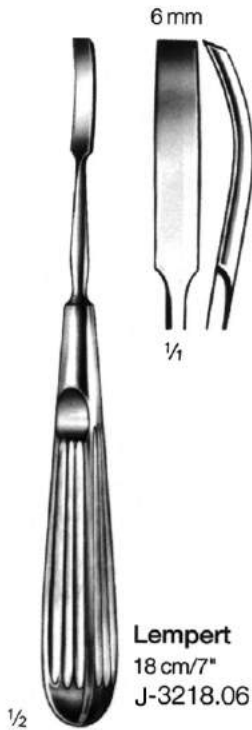

Lempert
 18 cm/7"
 J-3218.06

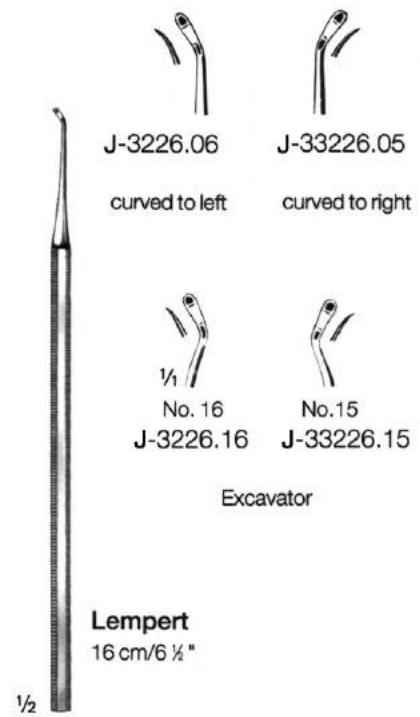

J-3226.06
 curved to left

J-33226.05
 curved to right

No. 16
 J-3226.16

No. 15
 J-33226.15

Excavator

Lempert
 16 cm/6 1/2"

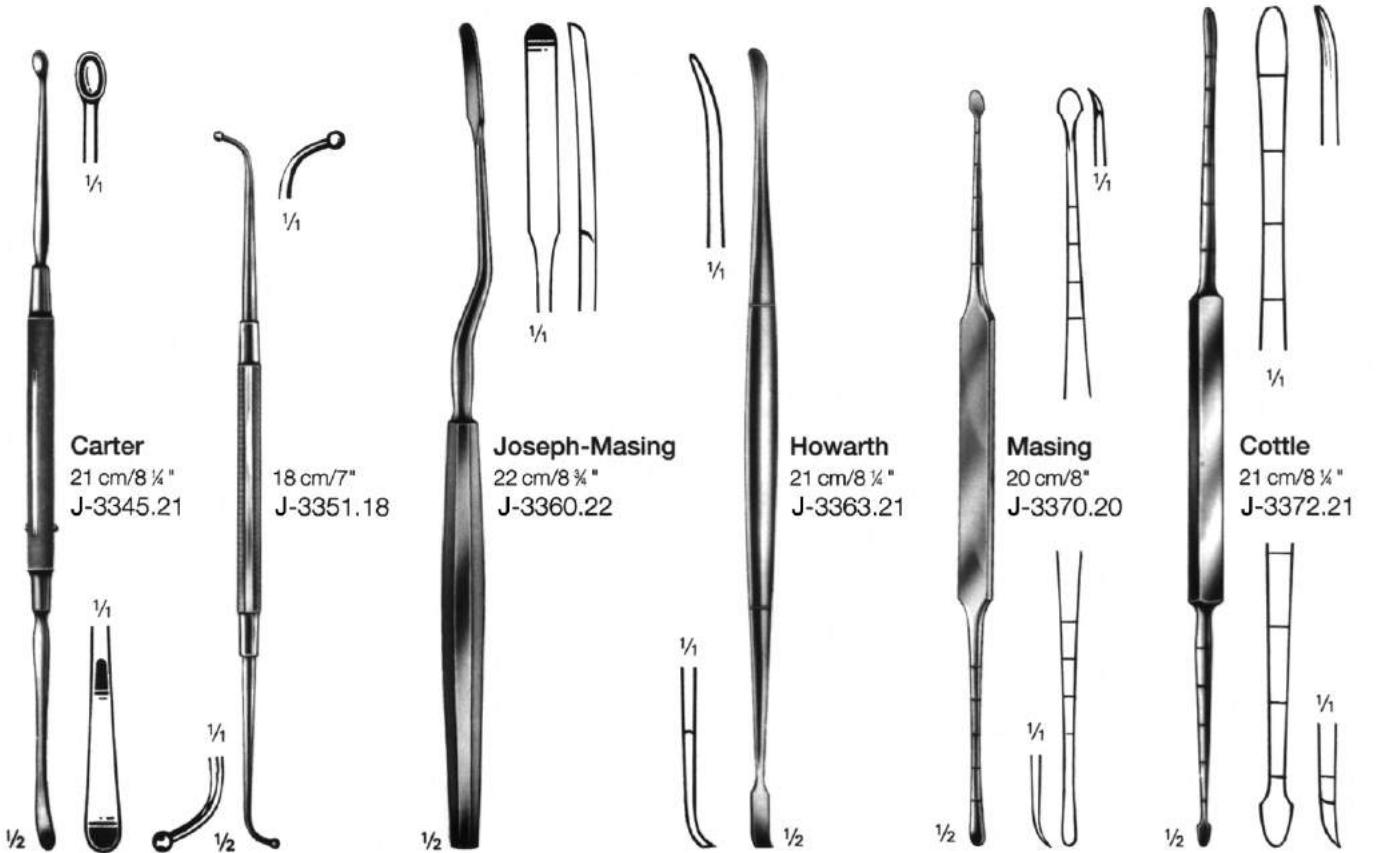
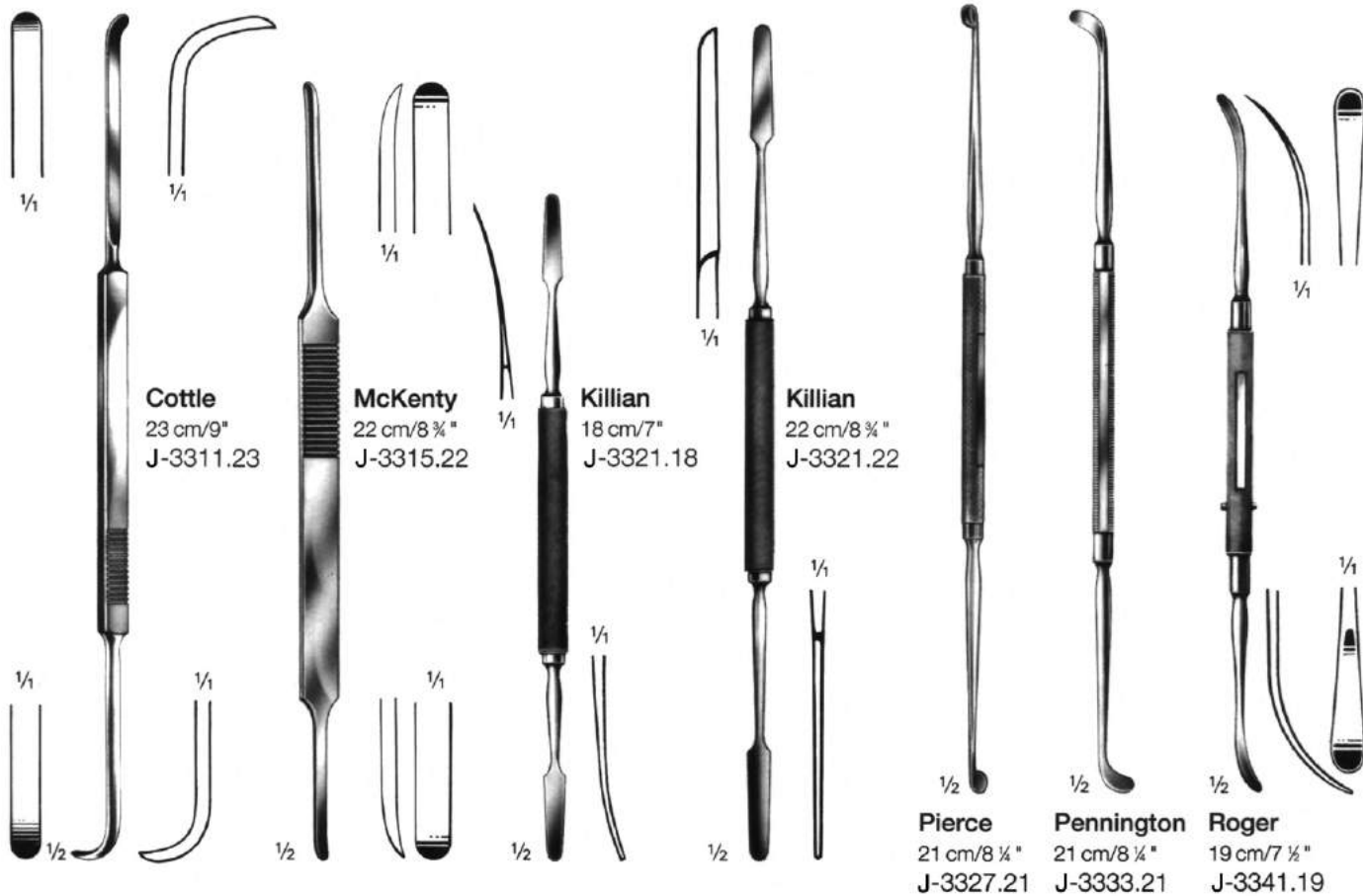



1/2
 19 cm/7 1/2"
 J-3419.06



1/2
 18,5 cm/7 1/4"
 J-3428.03

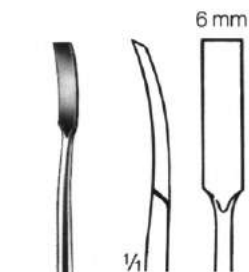

1/2
 18,5 cm/7 1/4"
 J-3438.06



1/2
 18,5 cm/7 1/4"
 J-3448.06

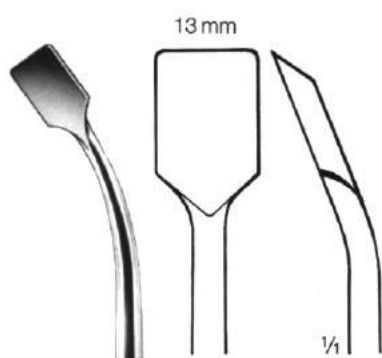

1/2
 18,5 cm/7 1/4"
 J-3458.13



1/2
 19,5 cm/7 3/4"
 J-3469.14



1/2
 18,5 cm/7 1/4"
 J-3478.14



1/2
 20 cm/8"
 J-3490.20

Raspatories with ferrozell-handle
Raspatoires avec manche Ferrozell
Periostótomos con mangos de Ferrozell (madera artificial)

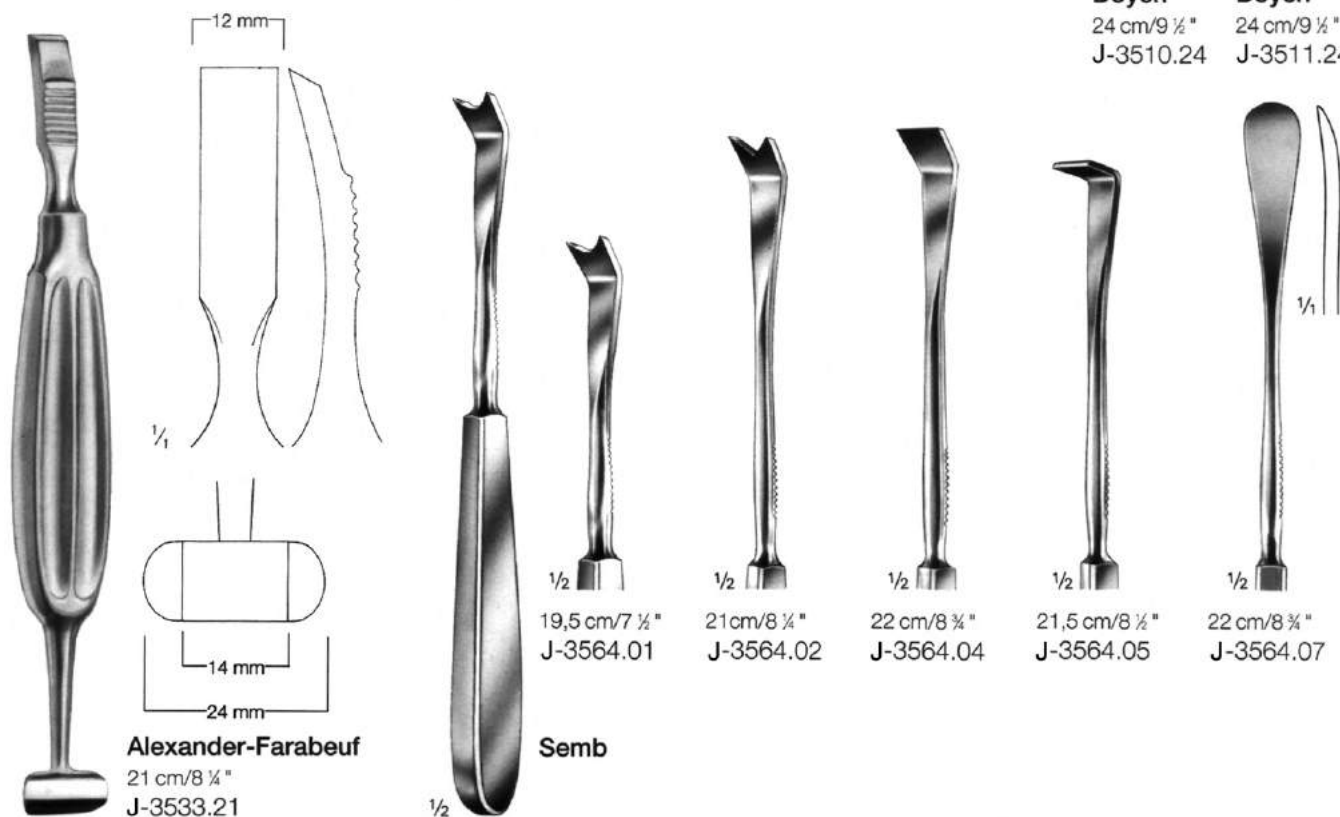
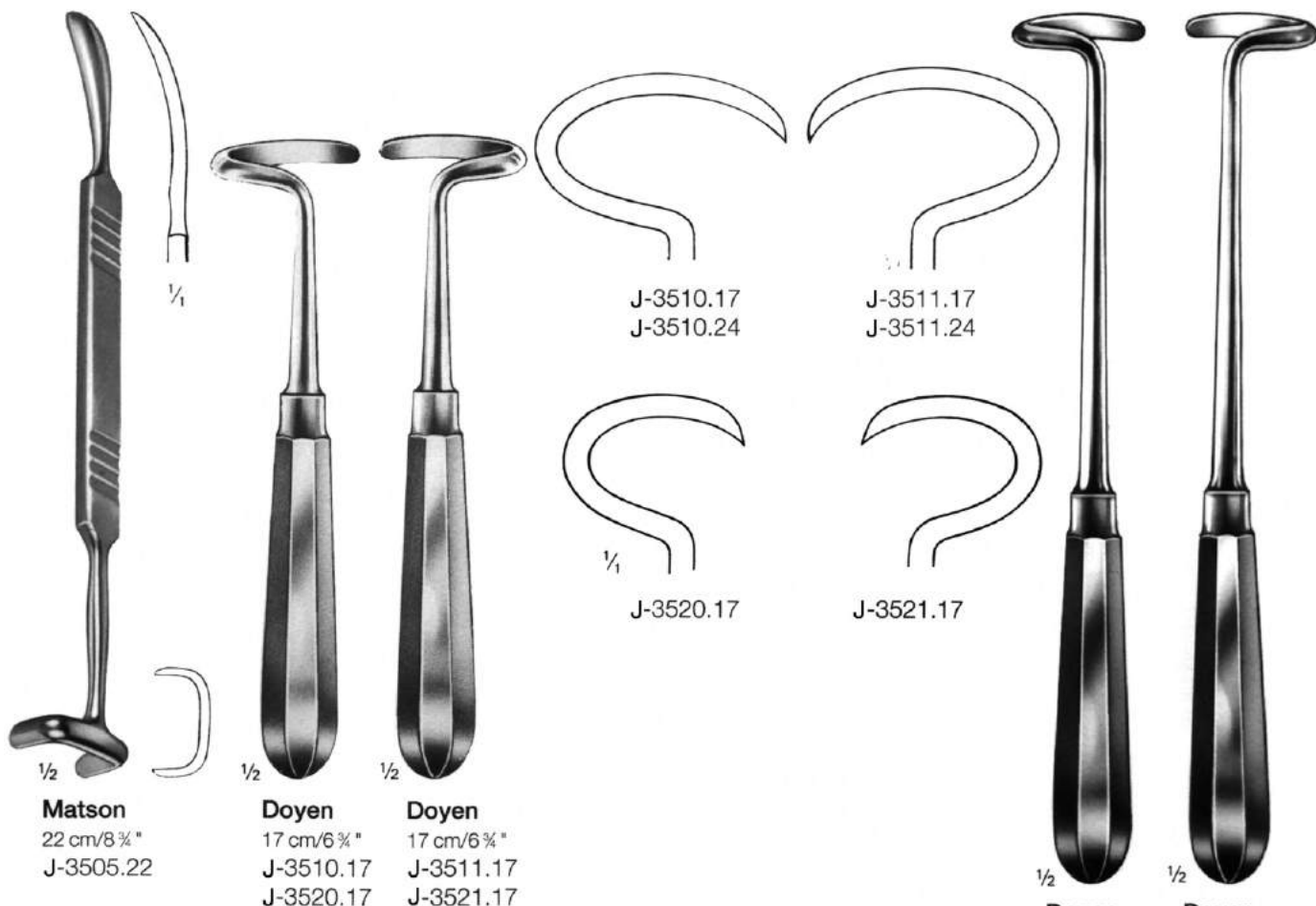



Langenbeck
23 cm/9"
J-4023.11



Yankauer
18 cm/7"
J-4027.18



Mass. Gen. Hosp.
15 cm/6"
J-4033.15

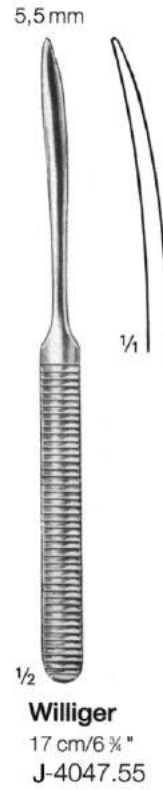

Williger
17 cm/6 3/4"
J-4047.55

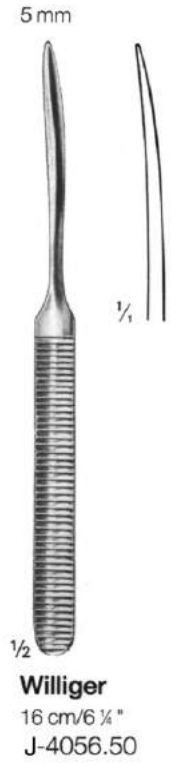

Williger
16 cm/6 1/4"
J-4056.50

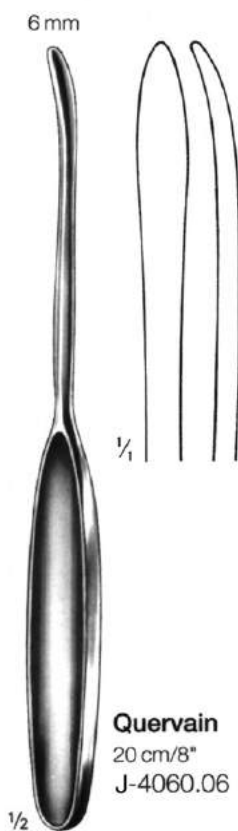

Quervain
20 cm/8"
J-4060.06

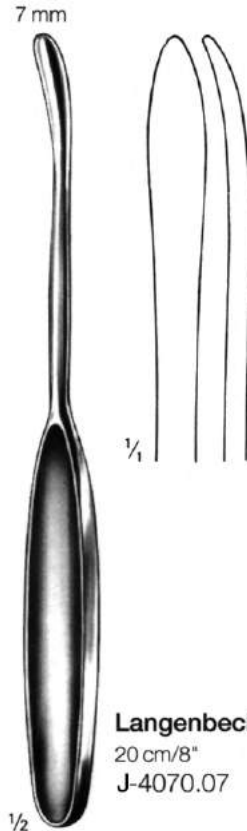

Langenbeck
20 cm/8"
J-4070.07

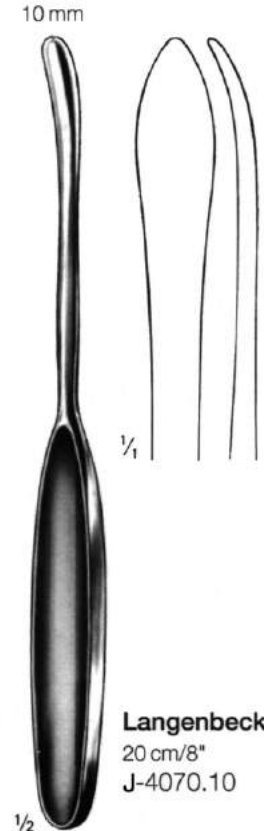

Langenbeck
20 cm/8"
J-4070.10

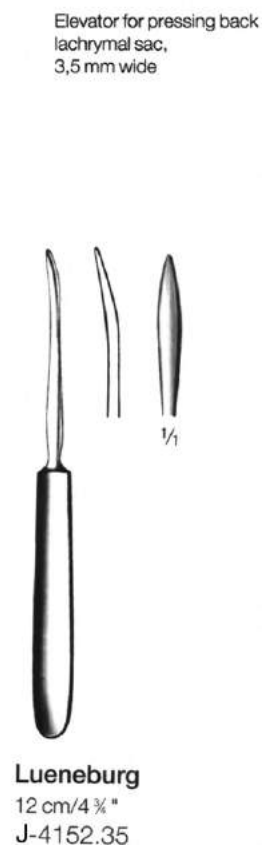
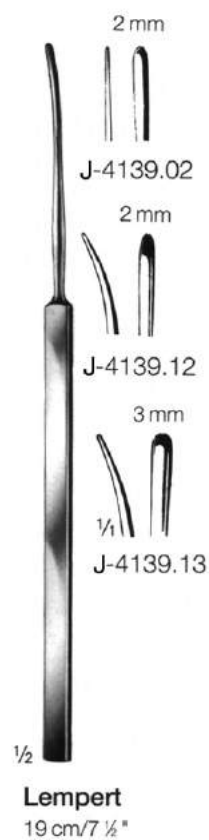
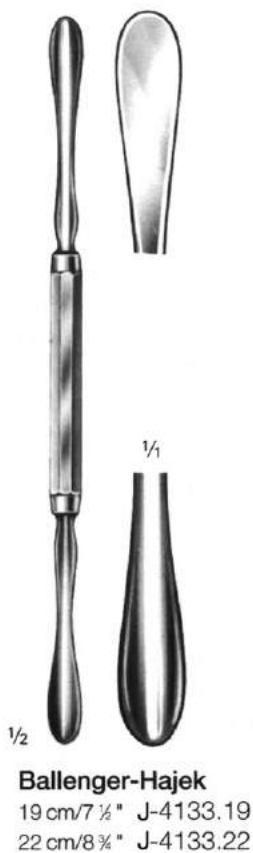
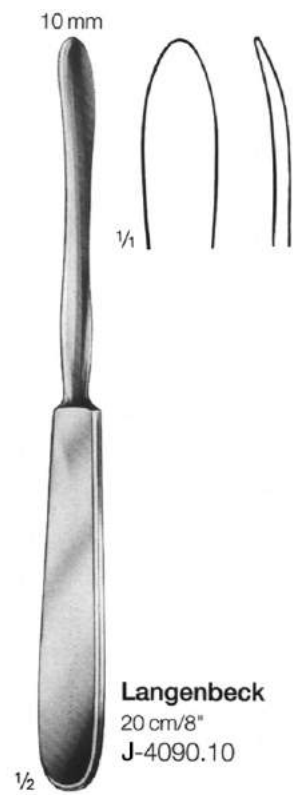
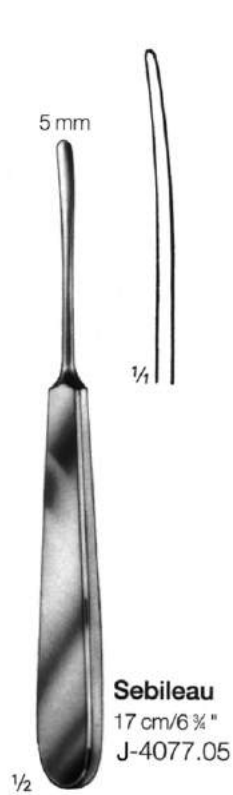



17,5 cm/6 3/4"
 J-4116.17



16 cm/6 1/4"
 J-4162.16



Halle
 16 cm/6 1/4"
 J-4164.16

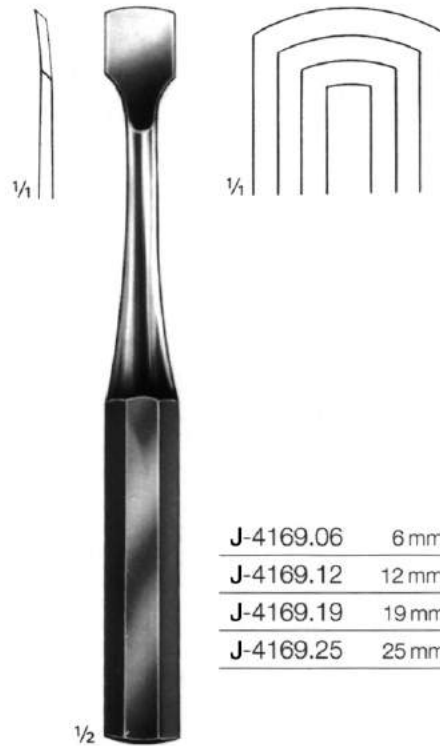

J-4169.06	6 mm
J-4169.12	12 mm
J-4169.19	19 mm
J-4169.25	25 mm

Key
 19 cm/7 1/2"

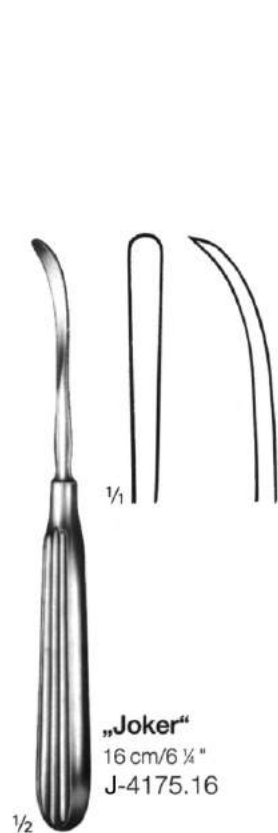

„Joker“
 16 cm/6 1/4"
 J-4175.16



Alderdyce
 21 cm/8 1/4"
 J-4181.21



McDonald
 19 cm/7 1/2"
 J-4183.19

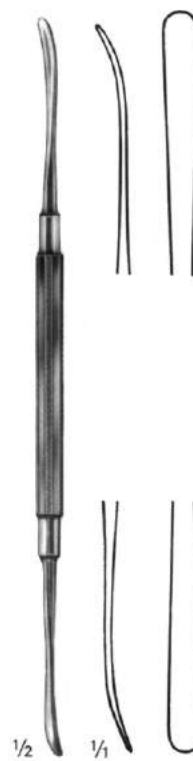

Freer
 18,5 cm/7 1/4"
 J-4185.18

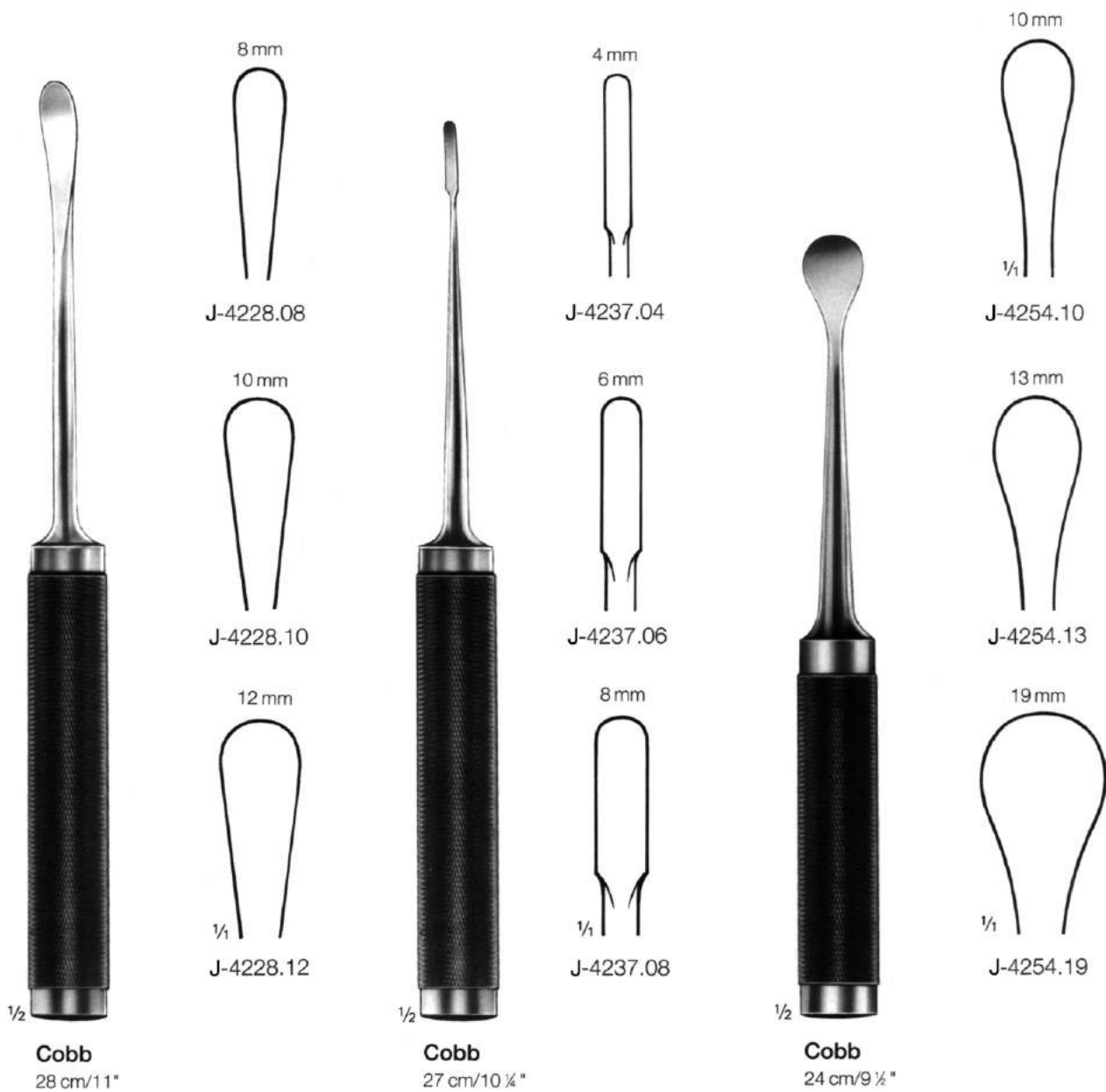

Dissectors, dura separators
Dissecteurs, séparateurs pour dure-mère
Disecadores, descoladores de dura-madre

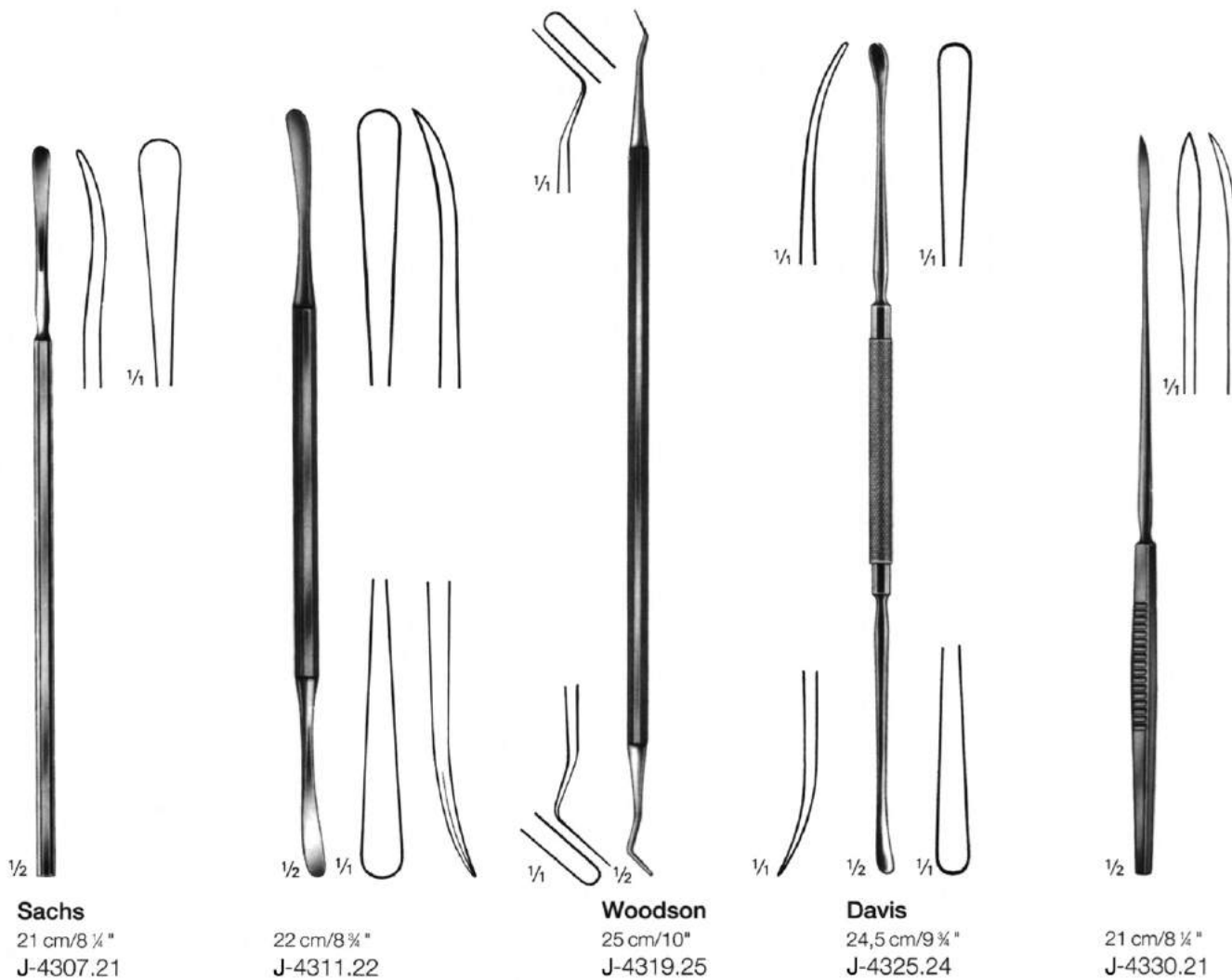

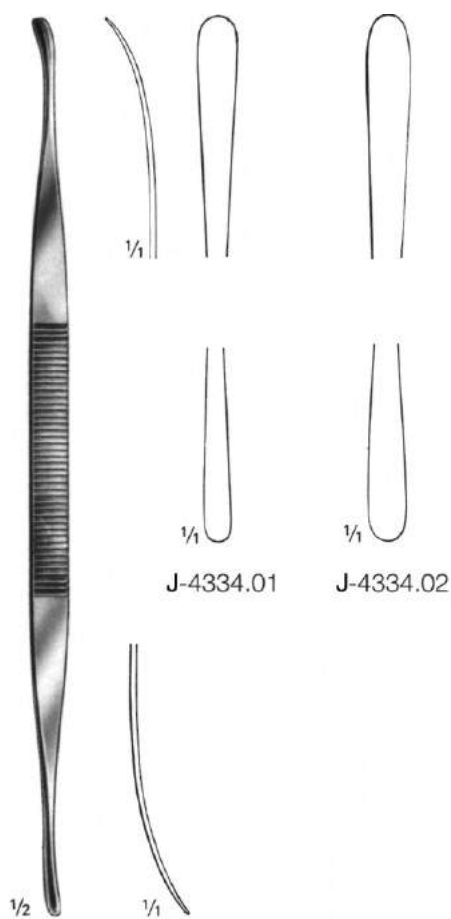

Tönnis
 24 cm/9 1/2"

J-4334.01

J-4334.02



Fager
 20 cm/8"
 J-4340.01



Fager
 20 cm/8"
 J-4340.02



Sachs
 21 cm/8 1/4"
 J-4350.21



Milligan
 21 cm/8 1/4"
 J-4355.21



Frazier
15 cm/6"
J-4365.01



Hoehn
15 cm/6"
J-4365.45



Hoehn
15 cm/6"
J-4365.90

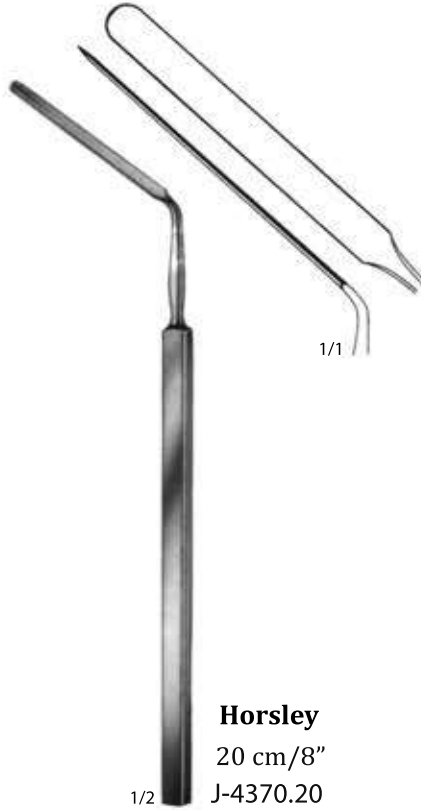

Horsley
20 cm/8"
J-4370.20

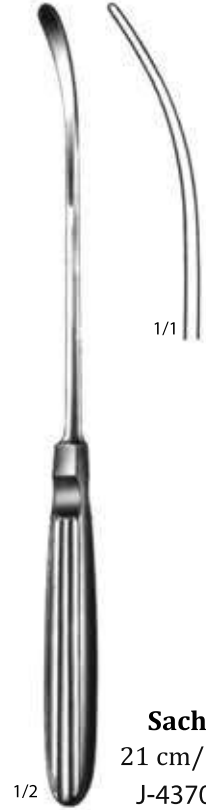

Sachs
21 cm/8.25"
J-4370.21

Zygoma bone hook



Gillies
18 cm/7"
J-4510.18

Zygoma elevator



Dingman
21 cm/8.25"
J-4513.21



Gillies
21 cm/8.25"
J-4525.21



Gillies
21 cm/8.25"
J-4527.21

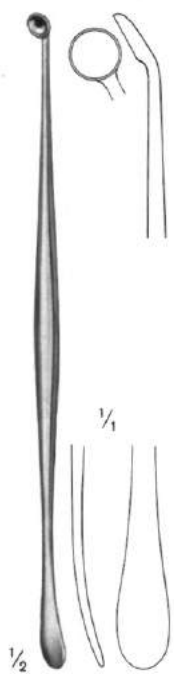

Penfield
 Fig. 1
 17,5 cm/7"
 J-4388.01



Penfield
 Fig. 2
 19,5 cm/7 3/4"
 J-4388.02



Penfield
 Fig. 3
 19,5 cm/7 3/4"
 J-4388.03



Penfield
 Fig. 4
 20,5 cm/8"
 J-4388.04



Penfield
 Fig. 5
 29 cm/11 1/2"
 J-4388.05

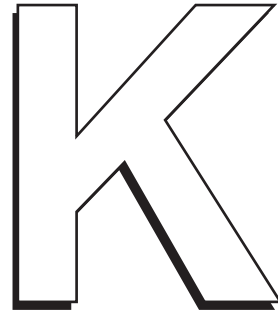

- Rongeurs
- Pincés-gouges
- Pinzas gubias

Laminectomy rongeurs





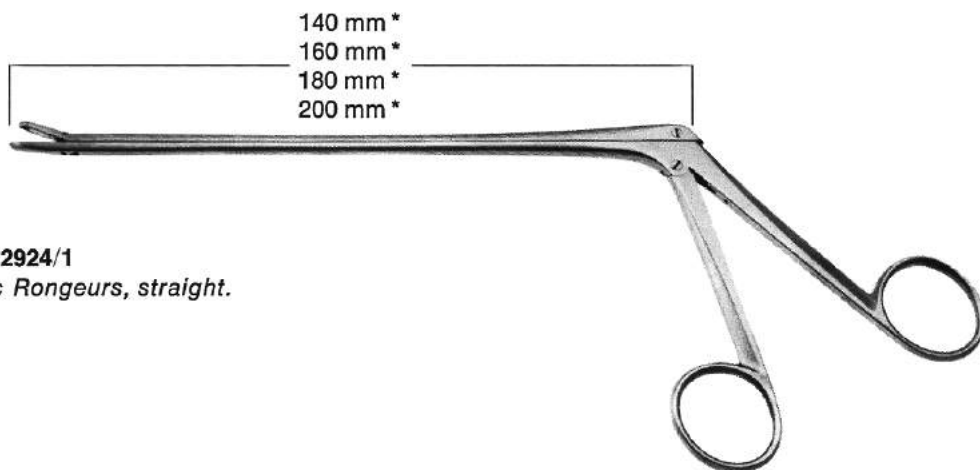









Pinces emporte-pièces à laminectomie

Pinzas cortantes para laminectomía









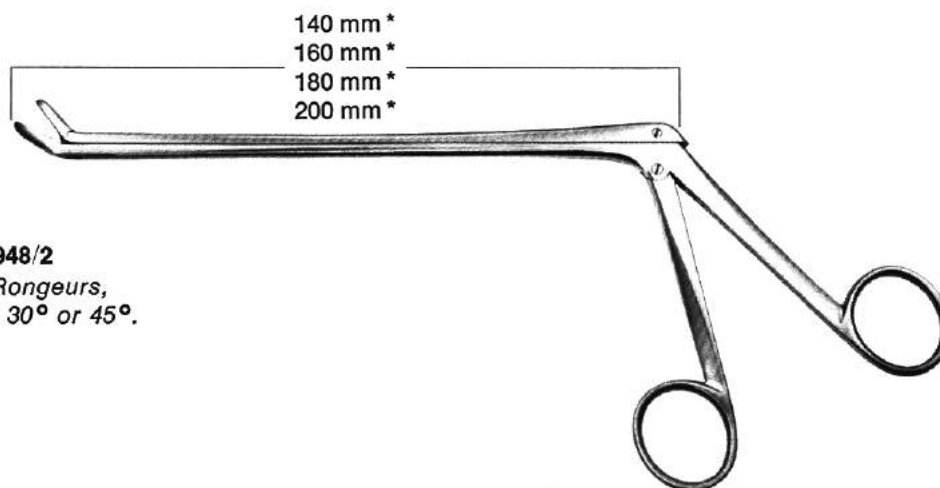







k-2770/1 To k-2924/1
Intervertebral Disc Rongeurs, straight.



<i>width of jaw</i>	140 mm *	160 mm *	180 mm *	200 mm *
 1,5 mm			k-2829/1	k-2901/1
 2,0 mm			k-2830/1	k-2902/1
 2,5 mm	k-2770/1	k-2800/1	k-2831/1	k-2903/1
 3,0 mm	k-2772/1	k-2802/1	k-2832/1	k-2904/1
 3,5 mm	k-2774/1	k-2804/1	k-2834/1	k-2906/1
 4,0 mm	k-2776/1	k-2806/1	k-2836/1	k-2908/1
 4,5 mm	k-2778/1	k-2808/1	k-2838/1	k-2910/1
 5,0 mm			k-2840/1	k-2912/1
 5,5 mm			k-2842/1	k-2914/1
 6,0 mm			k-2844/1	k-2916/1
 6,5 mm			k-2846/1	k-2918/1
 7,0 mm			k-2848/1	k-2920/1
 7,5 mm			k-2850/1	k-2922/1
 8,0 mm			k-2852/1	k-2924/1



K-2780/1 To K-2948/2
Intervertebral Disc Rongeurs,
jaws angled upward 30° or 45°.

Maulbreiten width of jaw	↘ 30°				↘ 45°			
	140 mm *	160 mm *	180 mm *	200 mm *	140 mm *	160 mm *	180 mm *	200 mm *
 1,5 mm			K-2853/1	K-2925/1			K-2853/2	K-2925/2
 2,0 mm			K-2854/1	K-2926/1			K-2854/2	K-2926/2
 2,5 mm	K-2780/1	K-2810/1	K-2855/1	K-2927/1	K-2780/2	K-2810/2	K-2855/2	K-2927/2
 3,0 mm	K-2782/1	K-2812/1	K-2856/1	K-2928/1	K-2782/2	K-2812/2	K-2856/2	K-2928/2
 3,5 mm	K-2784/1	K-2814/1	K-2858/1	K-2930/1	K-2784/2	K-2814/2	K-2858/2	K-2930/2
 4,0 mm	K-2786/1	K-2816/1	K-2860/1	K-2932/1	K-2786/2	K-2816/2	K-2860/2	K-2932/2
 4,5 mm	K-2788/1	K-2818/1	K-2862/1	K-2934/1	K-2788/2	K-2818/2	K-2862/2	K-2934/2
 5,0 mm			K-2864/1	K-2936/1			K-2864/2	K-2936/2
 5,5 mm			K-2866/1	K-2938/1			K-2866/2	K-2938/2
 6,0 mm			K-2868/1	K-2940/1			K-2868/2	K-2940/2
 6,5 mm			K-2870/1	K-2942/1			K-2870/2	K-2942/2
 7,0 mm			K-2872/1	K-2944/1			K-2872/2	K-2944/2
 7,5 mm			K-2874/1	K-2946/1			K-2874/2	K-2946/2
 8,0 mm			K-2876/1	K-2948/1			K-2876/2	K-2948/2

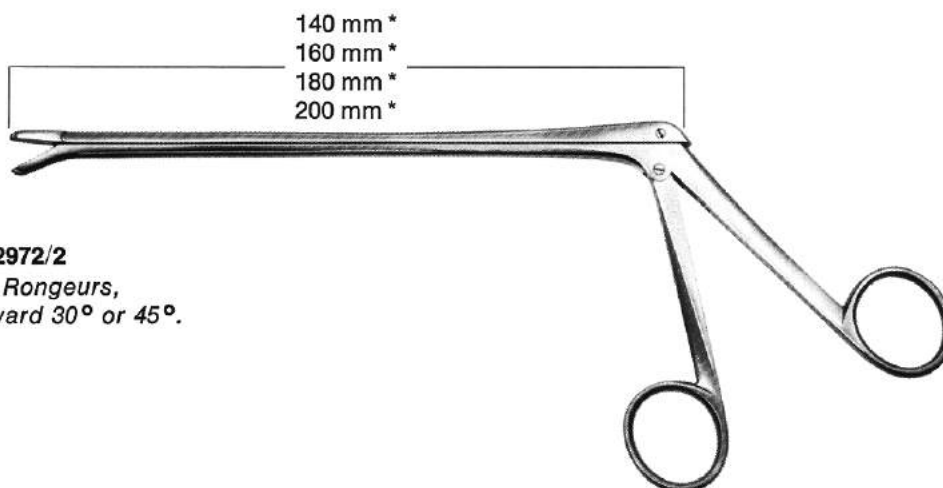

K-2790/1 To K-2972/2
Intervertebral Disc Rongeurs,
jaws angled downward 30° or 45°.







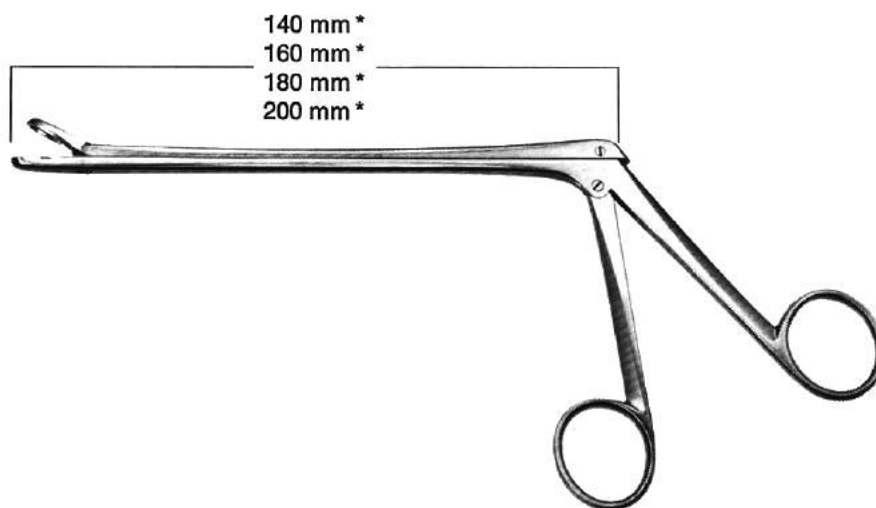

Maulbreiten width of jaw	30°				45°			
	140 mm *	160 mm *	180 mm *	200 mm *	140 mm *	160 mm *	180 mm *	200 mm *
1,5 mm			K-2877/1	K-2949/1			K-2877/2	K-2949/2
2,0 mm			K-2878/1	K-2950/1			K-2878/2	K-2950/2
2,5 mm	K-2790/1	K-2820/1	K-2879/1	K-2951/1	K-2790/2	K-2820/2	K-2879/2	K-2951/2
3,0 mm	K-2792/1	K-2822/1	K-2880/1	K-2952/1	K-2792/2	K-2822/2	K-2880/2	K-2952/2
3,5 mm	K-2794/1	K-2824/1	K-2882/1	K-2954/1	K-2794/2	K-2824/2	K-2882/2	K-2954/2
4,0 mm	K-2796/1	K-2826/1	K-2884/1	K-2956/1	K-2796/2	K-2826/2	K-2884/2	K-2956/2
4,5 mm	K-2798/1	K-2828/1	K-2886/1	K-2958/1	K-2798/2	K-2828/2	K-2886/2	K-2958/2
5,0 mm			K-2888/1	K-2960/1			K-2888/2	K-2960/2
5,5 mm			K-2890/1	K-2962/1			K-2890/2	K-2962/2
6,0 mm			K-2892/1	K-2964/1			K-2892/2	K-2964/2
6,5 mm			K-2894/1	K-2966/1			K-2894/2	K-2966/2
7,0 mm			K-2896/1	K-2968/1			K-2896/2	K-2968/2
7,5 mm			K-2898/1	K-2970/1			K-2898/2	K-2970/2
8,0 mm			K-2900/1	K-2972/1			K-2900/2	K-2972/2









K-2774/11 To K-2916/11

*Spurling Intervertebral Disc Rongeurs,
 straight.*











Maulbreiten width of jaw	140 mm *	160 mm *	180 mm *	200 mm *
 3,5 mm	K-2774/11	K-2804/11	K-2834/11	K-2906/11
 4,0 mm	K-2776/11	K-2806/11	K-2836/11	K-2908/11
 4,5 mm	K-2778/11	K-2808/11	K-2838/11	K-2910/11
 5,0 mm			K-2840/11	K-2912/11
 5,5 mm			K-2842/11	K-2914/11
 6,0 mm			K-2844/11	K-2916/11

K-2784/11 To K-2940/21
Spurling Intervertebral Disc Rongeurs,
angled upward 30° or 45°.

Maulbreiten width of jaw	 $\sphericalangle 30^\circ$				 $\sphericalangle 45^\circ$			
	140 mm *	160 mm *	180 mm *	200 mm *	140 mm *	160 mm *	180 mm *	200 mm *
 3,5 mm	K-2784/11	K-2814/11	K-2858/11	K-2930/11	K-2784/21	K-2814/21	K-2858/21	K-2930/21
 4,0 mm	K-2786/11	K-2816/11	K-2860/11	K-2932/11	K-2786/21	K-2816/21	K-2860/21	K-2932/21
 4,5 mm	K-2788/11	K-2818/11	K-2862/11	K-2934/11	K-2788/21	K-2818/21	K-2862/21	K-2934/21
 5,0 mm			K-2864/11	K-2936/11			K-2864/21	K-2936/21
 5,5 mm			K-2866/11	K-2938/11			K-2866/21	K-2938/21
 6,0 mm			K-2868/11	K-2940/11			K-2868/21	K-2940/21

K-2794/11 To K-2964/21
Spurling Intervertebral Disc Rongeurs,
angled downward 30° or 45°.

Maulbreiten width of jaw	 $\sphericalangle 30^\circ$				 $\sphericalangle 45^\circ$			
	140 mm *	160 mm *	180 mm *	200 mm *	140 mm *	160 mm *	180 mm *	200 mm *
 3,5 mm	K-2794/11	K-2824/11	K-2882/11	K-2954/11	K-2794/21	K-2824/21	K-2882/21	K-2954/21
 4,0 mm	K-2796/11	K-2826/11	K-2884/11	K-2956/11	K-2796/21	K-2826/21	K-2884/21	K-2956/21
 4,5 mm	K-2798/11	K-2828/11	K-2886/11	K-2958/11	K-2798/21	K-2828/21	K-2886/21	K-2958/21
 5,0 mm			K-2888/11	K-2960/11			K-2888/21	K-2960/21
 5,5 mm			K-2890/11	K-2962/11			K-2890/21	K-2962/21
 6,0 mm			K-2892/11	K-2964/11			K-2892/21	K-2964/21

K-2976/1

*Spurling Intervertebral Disc Rongeur, angled to left, 3 mm wide jaws, 180 mm long.**

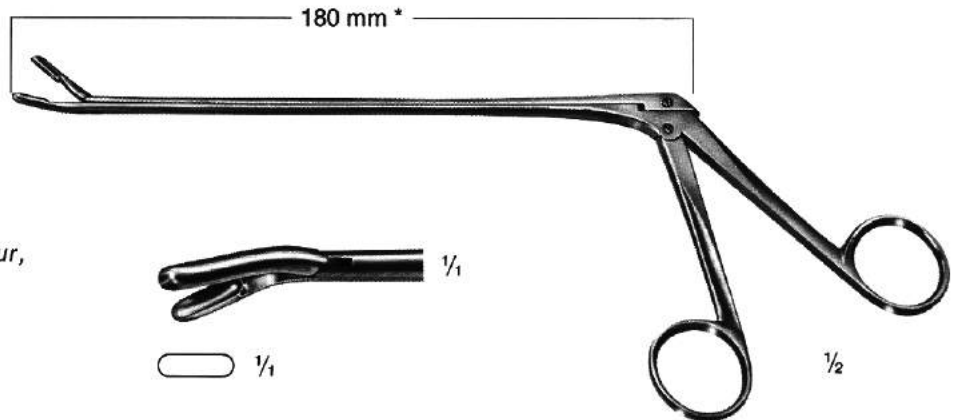

K-2976/2

*Spurling Intervertebral Disc Rongeur, angled to right, 3 mm wide jaws, 180 mm long.**

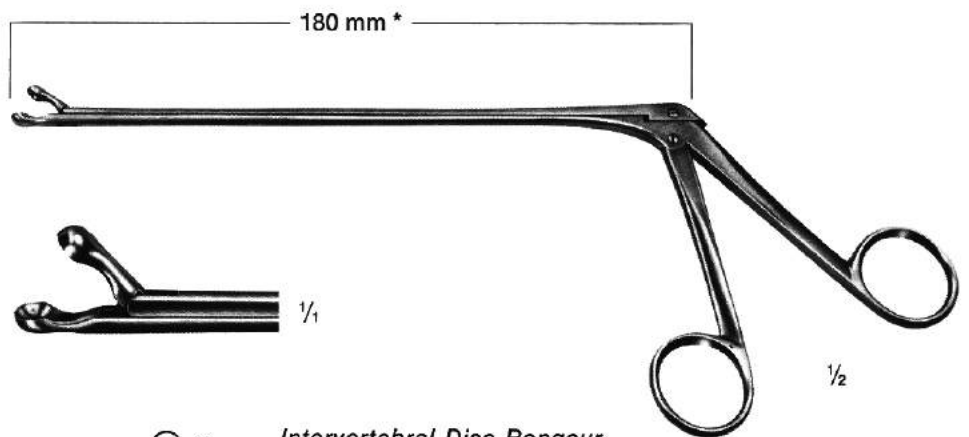
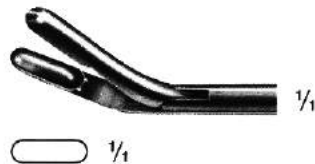

K-2977/1

○ 1/4 *Intervertebral Disc Rongeur, 4 mm diameter round cup, 180 mm long.**

K-2977/2

○ 1/4 *Intervertebral Disc Rongeur, 5 mm diameter round cup, 180 mm long.**

K-2977/3

○ 1/4 *Intervertebral Disc Rongeur, 6 mm diameter round cup, 180 mm long.**

K-2978/1

*Peapod Rongeur, angled upward,
 2.5 mm wide jaws, 140 mm long.**

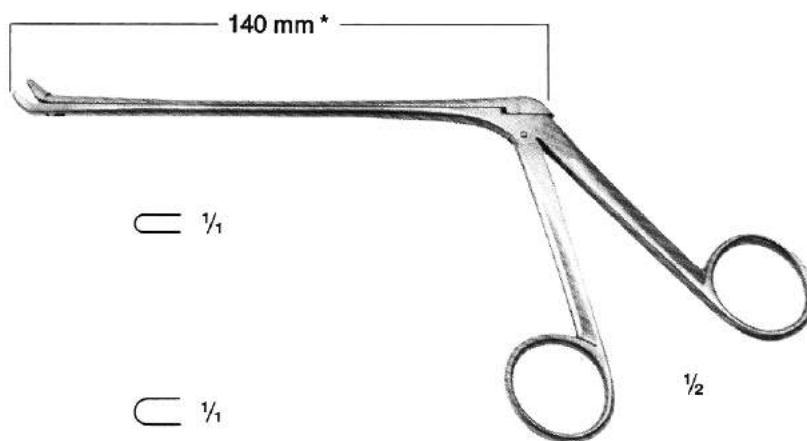

K-2978/2

*Peapod Rongeur, angled upward,
 3.5 mm wide jaws, 140 mm long.**

1/1

1/1

1/2

K-2979

*Jackson Rongeur, angled upward,
 4 mm wide jaws, 180 mm long.**

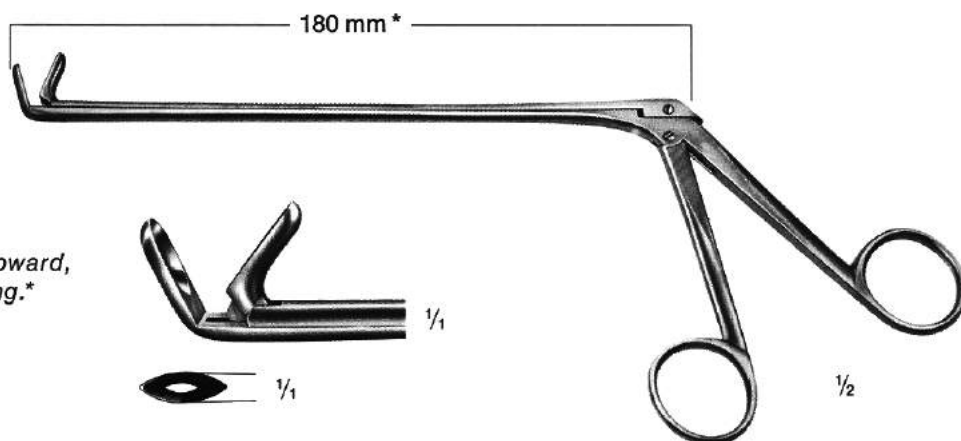

1/1







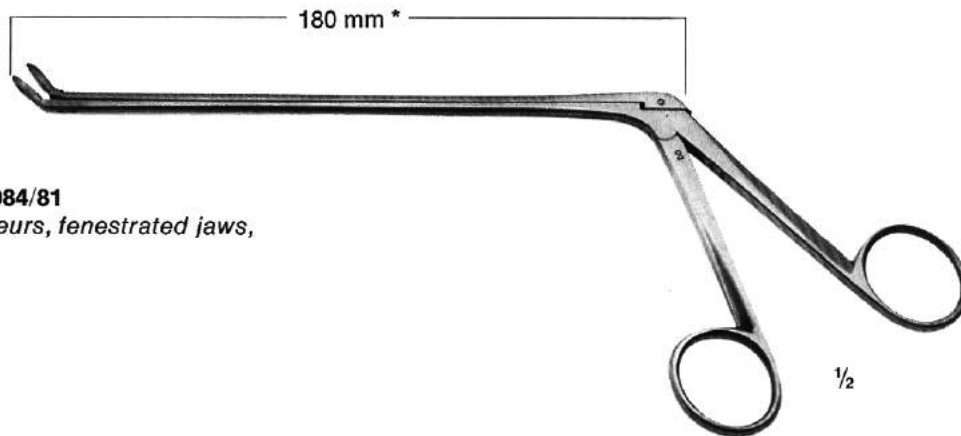







1/1

1/2

Laminectomy rongeurs
Pinces emporte-pièces à laminectomie
Pinzas cortantes para laminectomía







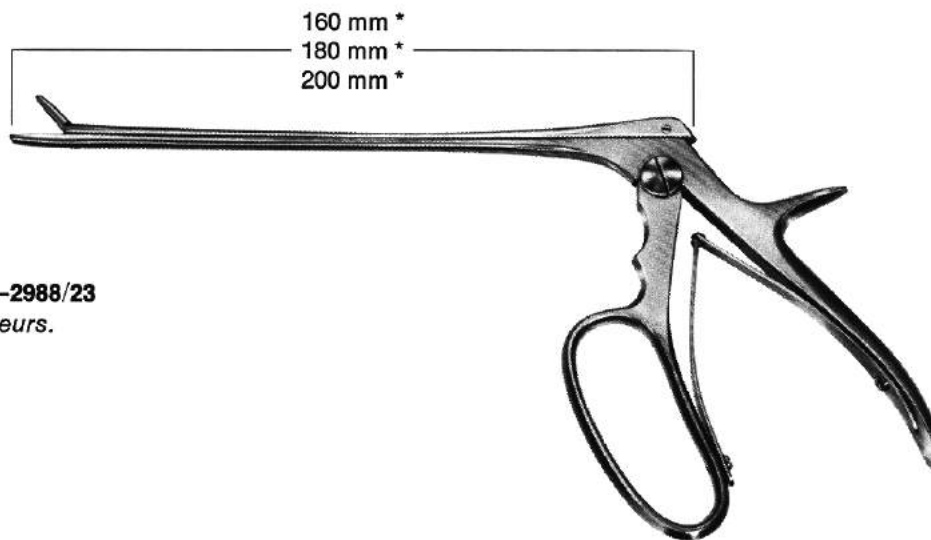









K-2980/1 To K-2984/81
Weil-Blakesley Rongeurs, fenestrated jaws,
*180 mm long.**

width of jaw	Jaws				
	<i>Straight Jaws</i>	<i>Jaws 30° angled upward</i>	<i>Jaws 45° angled upward</i>	<i>Jaws 30° angled downward</i>	<i>Jaws 45° angled downward</i>
 2,5 mm	 1/1	 1/1	 1/1	 1/1	 1/1
 3,0 mm	K-2980/1	K-2982/1	K-2982/11	K-2984/1	K-2984/11
 3,5 mm	K-2980/2	K-2982/2	K-2982/21	K-2984/2	K-2984/21
 4,0 mm	K-2980/3	K-2982/3	K-2982/31	K-2984/3	K-2984/31
 4,5 mm	K-2980/4	K-2982/4	K-2982/41	K-2984/4	K-2984/41
 5,0 mm	K-2980/5	K-2982/5	K-2982/51	K-2984/5	K-2984/51
 5,5 mm	K-2980/6	K-2982/6	K-2982/61	K-2984/6	K-2984/61
 6,0 mm	K-2980/7	K-2982/7	K-2982/71	K-2984/7	K-2984/71
 6,0 mm	K-2980/8	K-2982/8	K-2982/81	K-2984/8	K-2984/81







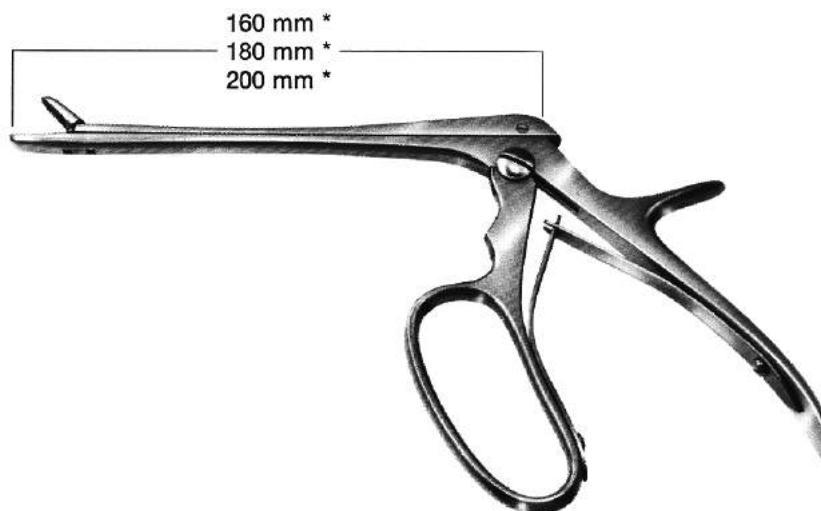



K-2985/1 To K-2988/23
Ferris-Smith Rongeurs.

		Maulbreiten width of jaw	Längen / length		
			160 mm *	180 mm *	200 mm *
Straight Jaws		 2,5 mm	K-2985/1	K-2985/2	K-2985/3
		 3,0 mm	K-2986/1	K-2986/2	K-2986/3
		 3,5 mm	K-2987/1	K-2987/2	K-2987/3
		 4,0 mm	K-2988/1	K-2988/2	K-2988/3
Jaws 30° angled upward		 2,5 mm	K-2985/11	K-2985/12	K-2985/13
		 3,0 mm	K-2986/11	K-2986/12	K-2986/13
		 3,5 mm	K-2987/11	K-2987/12	K-2987/13
		 4,0 mm	K-2988/11	K-2988/12	K-2988/13
Jaws 30° angled downward		 2,5 mm	K-2985/21	K-2985/22	K-2985/23
		 3,0 mm	K-2986/21	K-2986/22	K-2986/23
		 3,5 mm	K-2987/21	K-2987/22	K-2987/23
		 4,0 mm	K-2988/21	75-2988/22	K-2988/23



K-2999/1 To K-2999/26
Cloward Type Rongeurs
 with Ferris-Smith handle,
 concave and serrated jaws.

		Maulbreiten width of jaw	Längen / length		
			160 mm *	180 mm *	200 mm *
Straight Jaws	 1/1	 4 mm	K-2999/1	K-2999/2	K-2999/3
		 6 mm	K-2999/4	K-2999/5	K-2999/6
Maul 30 ° Jaws 30 ° angled upward	 1/1	 4 mm	K-2999/11	K-2999/12	K-2999/13
		 6 mm	K-2999/14	K-2999/15	K-2999/16
Maul 30 ° Jaws 30 ° angled downward	 1/1	 4 mm	K-2999/21	K-2999/22	K-2999/23
		 6 mm	K-2999/24	K-2999/25	K-2999/26

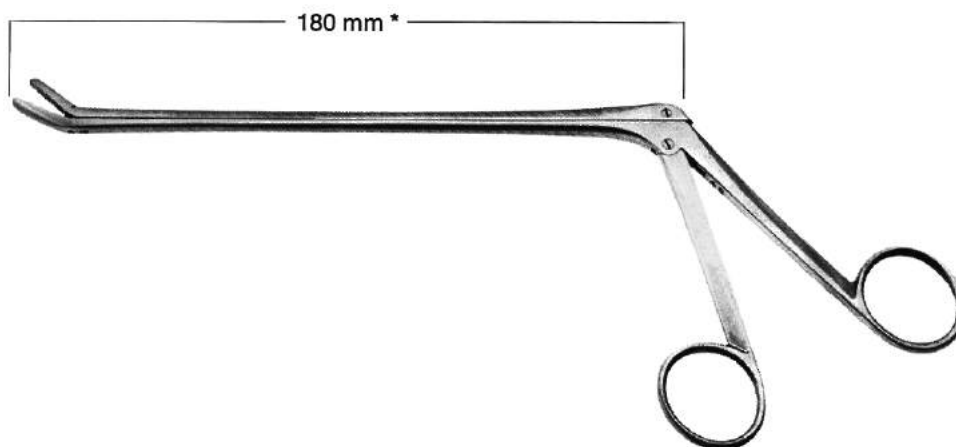

K-2990/1 To K-2990/3



*Hoffman Grasping Forceps,
 straight, serrated jaws, 180 mm long.**

K-2992/1 To K-2992/3





*Hoffman Grasping Forceps,
 angled 30° upward, serrated jaws,
 180 mm long.**

K-2994/1 To K-2994/3



*Hoffman Grasping Forceps,
 angled 30° downward, serrated jaws,
 180 mm long.**

Maulbreiten width of jaw			
 2,5 mm	K-2990/1	K-2992/1	K-2994/1
 3,0 mm	K-2990/2	K-2992/2	K-2994/2
 4,0 mm	K-2990/3	K-2992/3	K-2994/3

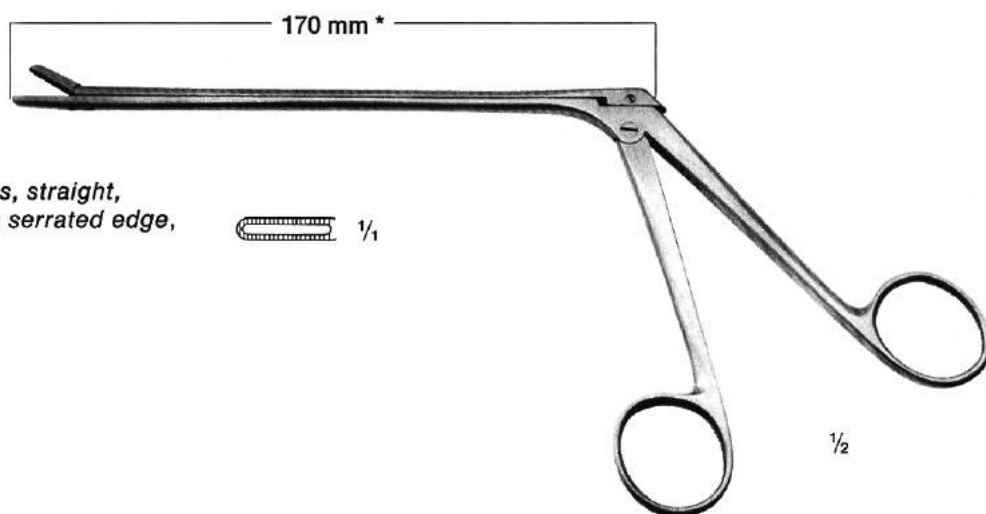

K-2995

*Schlesinger Grasping Forceps, straight,
 3 mm wide oval cup jaws with serrated edge,
 170 mm long.**

$\frac{1}{2}$

$\frac{1}{2}$

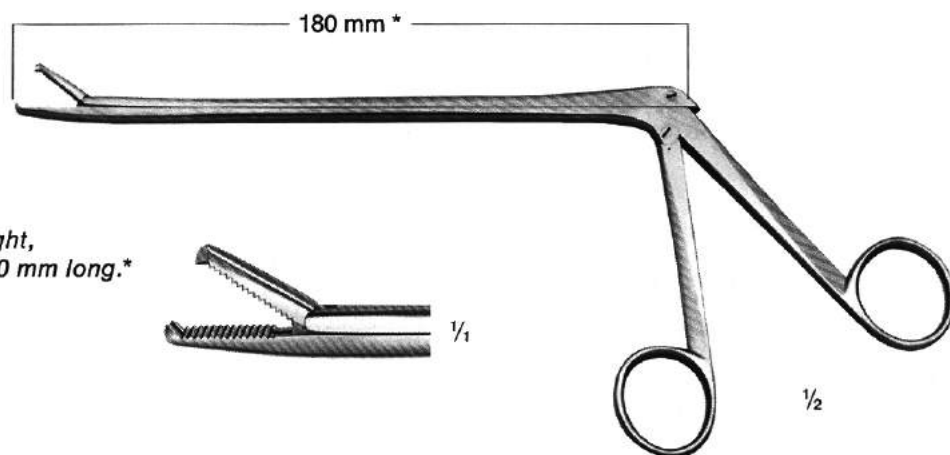

K-2996

*Munich Grasping Forceps, straight,
 serrated jaws and 1 x 2 teeth, 180 mm long.**

$\frac{1}{2}$

$\frac{1}{2}$

Rongeur Handles

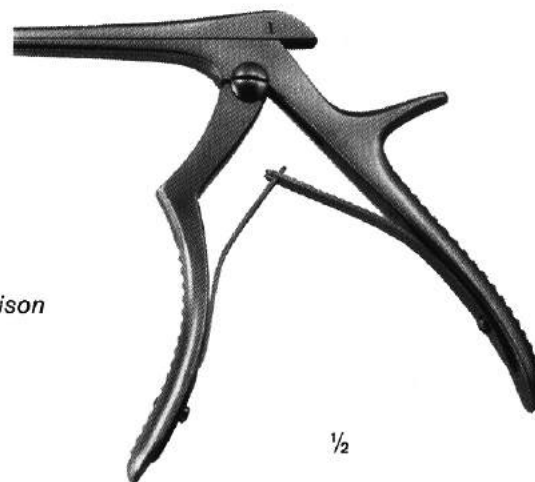

Small Kerrison

1/2



Large Kerrison

1/2



Ferris-Smith-Kerrison ring handle

1/2

Laminectomy rongeurs

Pincas emporte-pièces à laminectomie

Pinzas cortantes para laminectomía

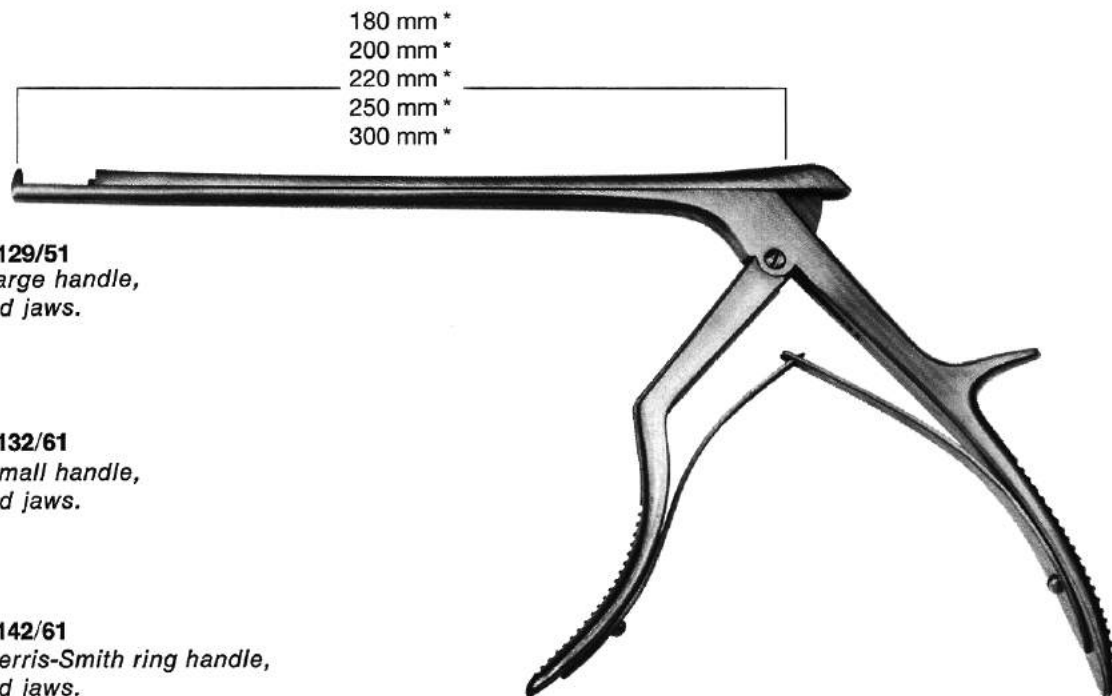

K-3120/11 To K-3129/51
Kerrison Rongeurs, large handle,
up-cutting, 90° angled jaws.

K-3130/11 To K-3132/61
Kerrison Rongeurs, small handle,
up-cutting, 90° angled jaws.

K-3140/11 To K-3142/61
Kerrison Rongeurs, Ferris-Smith ring handle,
up-cutting, 90° angled jaws.

Size of jaw width x height mm	Large Kerrison					Small Kerrison		Kerrison Ferris-Smith- Kerrison	
	180 mm*	200 mm*	220 mm*	250 mm*	300 mm*	180 mm*	200 mm*	180 mm*	200 mm*
∩ 2,5 x 2,5	K-3120/11	K-3122/11	K-3124/11			K-3130/11	K-3132/11	K-3140/11	K-3142/11
∩ 2,0 x 3,0	K-3120/21	K-3122/21	K-3124/21	K-3125/21	K-3129/21	K-3130/21	K-3132/21	K-3140/21	K-3142/21
<i>with ejector</i>									
∩ 3,0 x 4,0	K-3120/31	K-3122/31	K-3124/31	K-3125/31	K-3129/31	K-3130/31	K-3132/31	K-3140/31	K-3142/31
∩ 4,0 x 5,0	K-3120/41	K-3122/41	K-3124/41	K-3125/41	K-3129/41	K-3130/41	K-3132/41	K-3140/41	K-3142/41
∩ 5,0 x 5,0	K-3120/51	K-3122/51	K-3124/51	K-3125/51	K-3129/51	K-3130/51	K-3132/51	K-3140/51	K-3142/51
∩ 6,0 x 5,0	K-3120/61	K-3122/61	K-3124/61			K-3130/61	K-3132/61	K-3140/61	K-3142/61
∩ 7,0 x 6,0	K-3120/71	K-3122/71	K-3124/71						

Laminectomy rongeurs

Pinces emporte-pièces à laminectomie

Pinzas cortantes para laminectomía

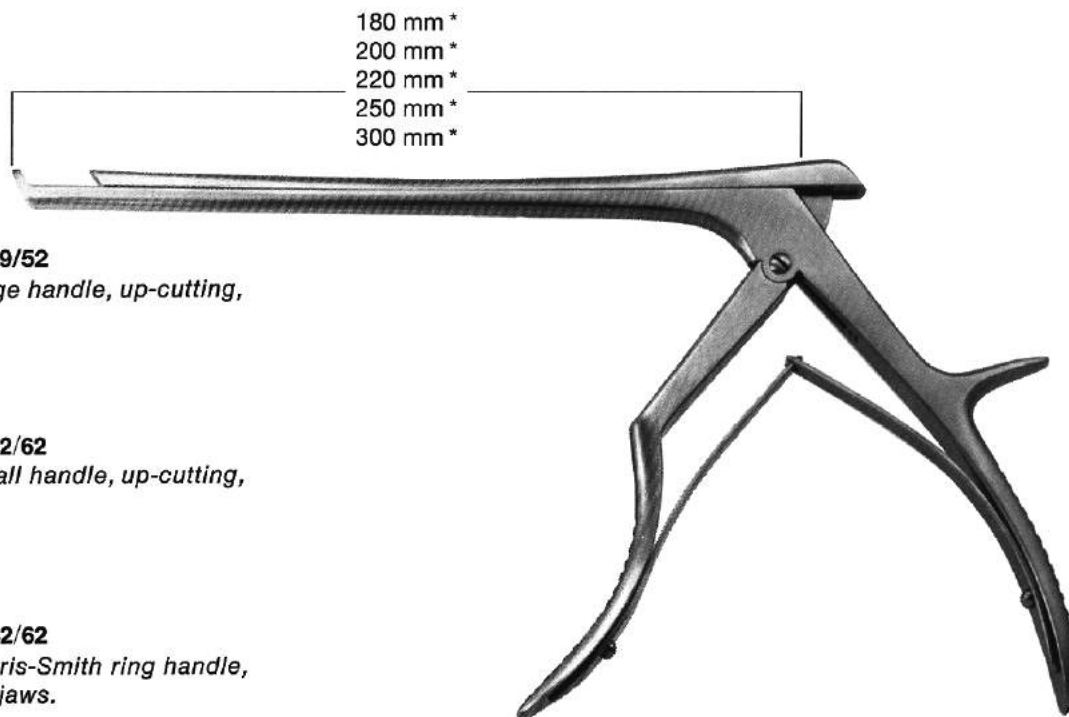

K-3120/12 To K-3129/52







Kerrison Rongeurs, large handle, up-cutting, 50° angled jaws.

K-3130/12 To K-3132/62

Kerrison Rongeurs, small handle, up-cutting, 50° angled jaws.

K-3140/12 To K-3142/62

Kerrison Rongeurs, Ferris-Smith ring handle, up-cutting, 50° angled jaws.

Breite x Höhe width x height mm	Large Kerrison					Small Kerrison		Ferris-Smith-Kerrison	
	180 mm*	200 mm*	220 mm*	250 mm*	300 mm*	180 mm*	200 mm*	180 mm*	200 mm*
 2,5 x 2,5	K-3120/12	K-3122/12	K-3124/12			K-3130/12	K-3132/12	K-3140/12	K-3142/12
 2,0 x 3,0	K-3120/22	K-3122/22	K-3124/22	K-3125/22	K-3129/22	K-3130/22	K-3132/22	K-3140/22	K-3142/22
<i>with ejector</i>									
 3,0 x 4,0	K-3120/32	K-3122/32	K-3124/32	K-3125/32	K-3129/32	K-3130/32	K-3132/32	K-3140/32	K-3142/32
 4,0 x 5,0	K-3120/42	K-3122/42	K-3124/42	K-3125/42	K-3129/42	K-3130/42	K-3132/42	K-3140/42	K-3142/42
 5,0 x 5,0	K-3120/52	K-3122/52	K-3124/52	K-3125/52	K-3129/52	K-3130/52	K-3132/52	K-3140/52	K-3142/52
 6,0 x 5,0	K-3120/62	K-3122/62	K-3124/62			K-3130/62	K-3132/62	K-3140/62	K-3142/62
 7,0 x 6,0	K-3120/72	K-3122/72	K-3124/72						

Laminectomy rongeurs

Pinces emporte-pièces à laminectomie

Pinzas cortantes para laminectomía

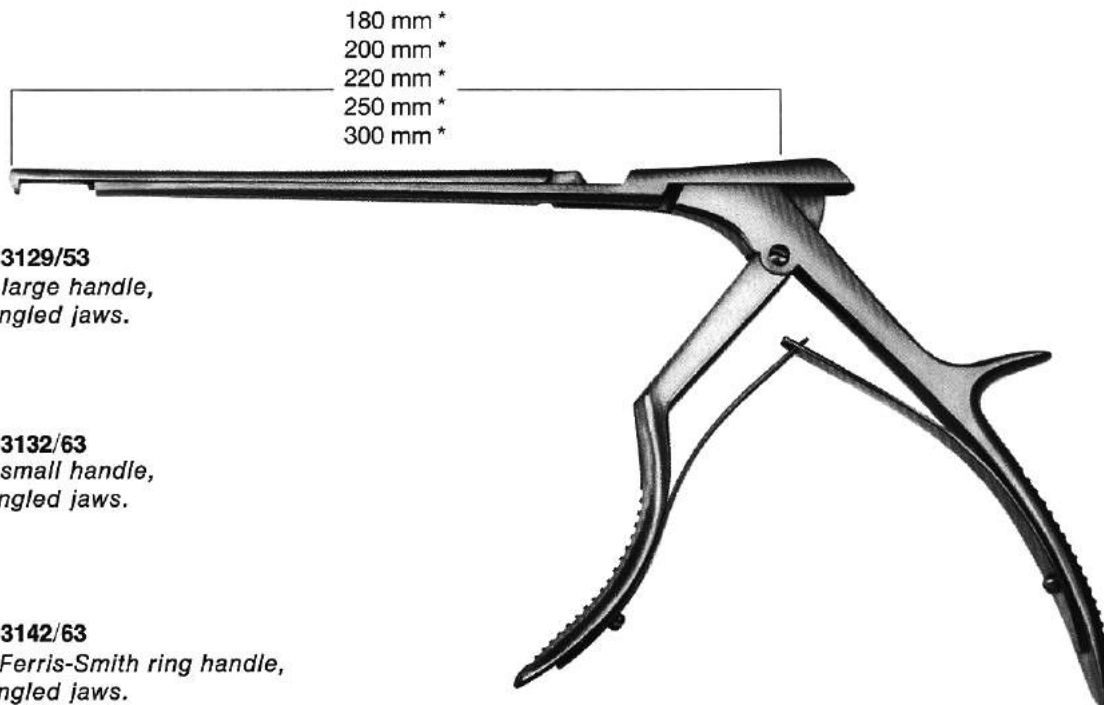

K-3120/13 To K-3129/53
Kerrison Rongeurs, large handle, down-cutting, 90° angled jaws.

K-3130/13 To K-3132/63
Kerrison Rongeurs, small handle, down-cutting, 90° angled jaws.

K-3140/13 To K-3142/63
Kerrison Rongeurs, Ferris-Smith ring handle, down-cutting, 90° angled jaws.

width x height mm	Large Kerrison					Small Kerrison		Ferris-Smith-Kerrison	
	180 mm*	200 mm*	220 mm*	250 mm*	300 mm*	180 mm*	200 mm*	180 mm*	200 mm*
U 2,5 x 2,5	K-3120/13	K-3122/13	K-3124/13			K-3130/13	K-3132/13	K-3140/13	K-3142/13
U 2,0 x 3,0	K-3120/23	K-3122/23	K-3124/23	K-3125/23	K-3129/23	K-3130/23	K-3132/23	K-3140/23	K-3142/23
<i>with ejector</i>									
U 3,0 x 4,0	K-3120/33	K-3122/33	K-3124/33	K-3125/33	K-3129/33	K-3130/33	K-3132/33	K-3140/33	K-3142/33
U 4,0 x 5,0	K-3120/43	K-3122/43	K-3124/43	K-3125/43	K-3129/43	K-3130/43	K-3132/43	K-3140/43	K-3142/43
U 5,0 x 5,0	K-3120/53	K-3122/53	K-3124/53	K-3125/53	K-3129/53	K-3130/53	K-3132/53	K-3140/53	K-3142/53
U 6,0 x 5,0	K-3120/63	K-3122/63	K-3124/63			K-3130/63	K-3132/63	K-3140/63	K-3142/63
U 7,0 x 6,0	K-3120/73	K-3122/73	K-3124/73						

Laminectomy rongeurs

Pincas emporte-pièces à laminectomie

Pinzas cortantes para laminectomía

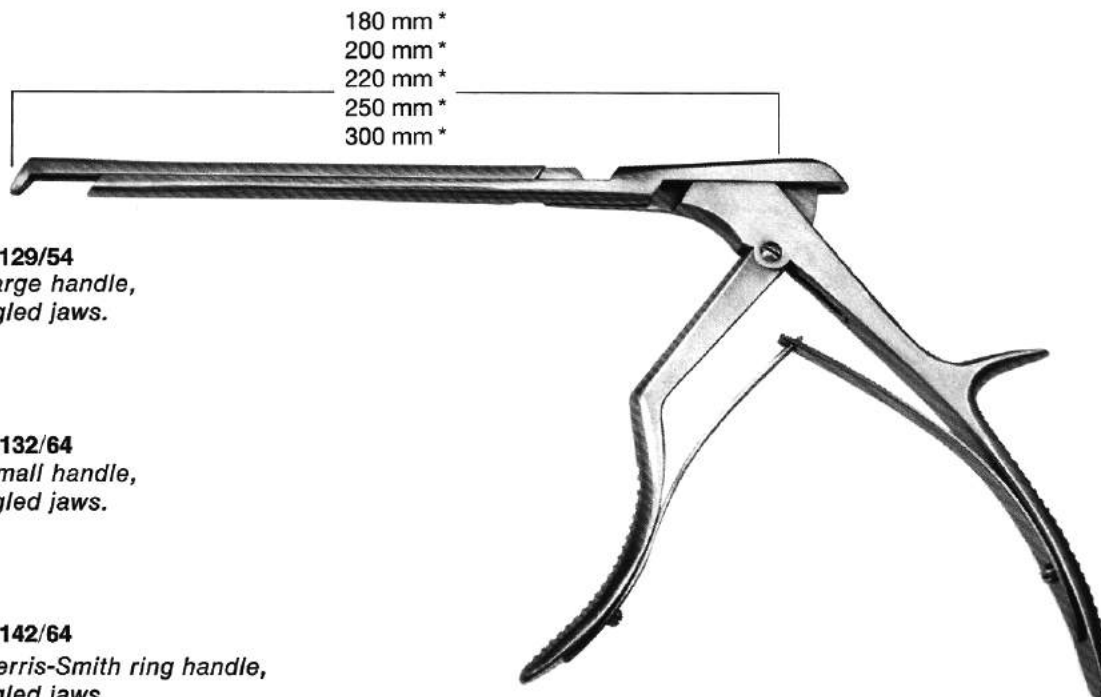

K-3120/14 To K-3129/54
Kerrison Rongeurs, large handle, down-cutting, 50° angled jaws.

K-3130/14 To K-3132/64
Kerrison Rongeurs, small handle, down-cutting, 50° angled jaws.

K-3140/14 To K-3142/64
Kerrison Rongeurs, Ferris-Smith ring handle, down-cutting, 50° angled jaws.

width x height mm	Large Kerrison					Small Kerrison		Ferris-Smith-Kerrison	
	180 mm*	200 mm*	220 mm*	250 mm*	300 mm*	180 mm*	200 mm*	180 mm*	200 mm*
U 2,5 x 2,5	K -3120/14	K -3122/14	K -3124/14			K -3130/14	K -3132/14	K -3140/14	K -3142/14
U 2,0 x 3,0	K -3120/24	K -3122/24	K -3124/24	K -3125/24	K -3129/24	K -3130/24	K -3132/24	K -3140/24	K -3142/24
U 3,0 x 4,0	K -3120/34	K -3122/34	K -3124/34	K -3125/34	K -3129/34	K -3130/34	K -3132/34	K -3140/34	K -3142/34
U 4,0 x 5,0	K -3120/44	K -3122/44	K -3124/44	K -3125/44	K -3129/44	K -3130/44	K -3132/44	K -3140/44	K -3142/44
U 5,0 x 5,0	K -3120/54	K -3122/54	K -3124/54	K -3125/54	K -3129/54	K -3130/54	K -3132/54	K -3140/54	K -3142/54
U 6,0 x 5,0	K -3120/64	K -3122/64	K -3124/64			K -3130/64	K -3132/64	K -3140/64	K -3142/64
U 7,0 x 6,0	K -3120/74	K -3122/74	K -3124/74						

Laminectomy rongeurs

Pinces emporte-pièces à laminectomie



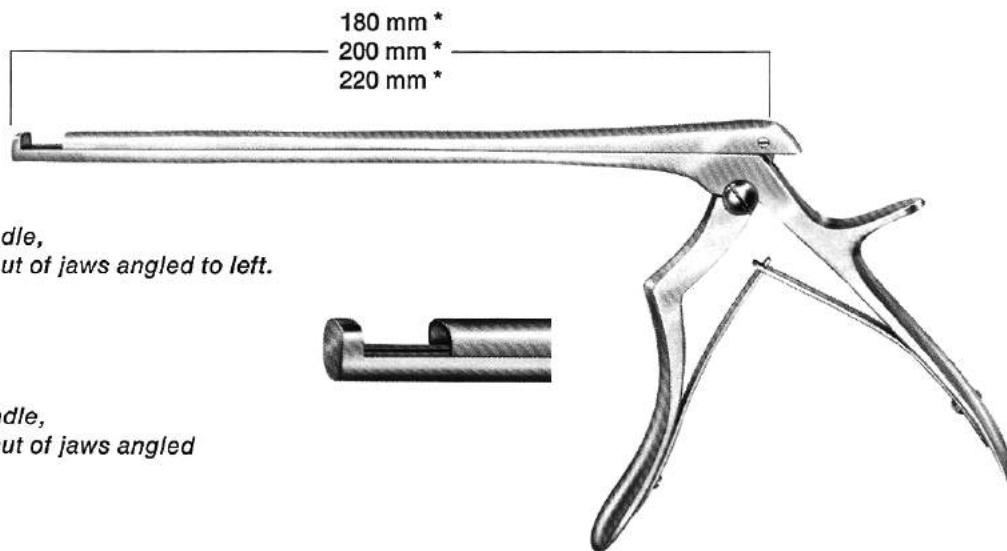



Pinzas cortantes para laminectomía



K-3120/15 To K-3124/75
Kerrison Rongeurs, large handle, up-cutting, 90° angled jaws, cut of jaws angled to left.

K-3130/15 To K-3132/65
Kerrison Rongeurs, small handle, up-cutting, 90° angled jaws, cut of jaws angled to left.

K-3140/15 To K-3142/65
Kerrison Rongeurs, Ferris-Smith ring handle, up-cutting, 90° angled jaws, cut of jaws angled to left.

width x height mm	Large Kerrison			Small Kerrison		Ferris-Smith-Kerrison	
	180 mm *	200 mm *	220 mm *	180 mm *	200 mm *	180 mm *	200 mm *
 2,5 x 2,5	K -3120/15	K -3122/15	K -3124/15	K -3130/15	K -3132/15	K -3140/15	K -3142/15
 2,0 x 3,0	K -3120/25	K -3122/25	K -3124/25	K -3130/25	K -3132/25	K -3140/25	K -3142/25
<i>with ejector</i>							
 3,0 x 4,0	K -3120/35	K -3122/35	K -3124/35	K -3130/35	K -3132/35	K -3140/35	K -3142/35
 4,0 x 5,0	K -3120/45	K -3122/45	K -3124/45	K -3130/45	K -3132/45	K -3140/45	K -3142/45
 5,0 x 5,0	K -3120/55	K -3122/55	K -3124/55	K -3130/55	K -3132/55	K -3140/55	K -3142/55
 6,0 x 5,0	K -3120/65	K -3122/65	K -3124/65	K -3130/65	K -3132/65	K -3140/65	K -3142/65
 7,0 x 6,0	K -3120/75	K -3122/75	K -3124/75				

Laminectomy rongeurs

Pincas emporte-pièces à laminectomie

Pinzas cortantes para laminectomía

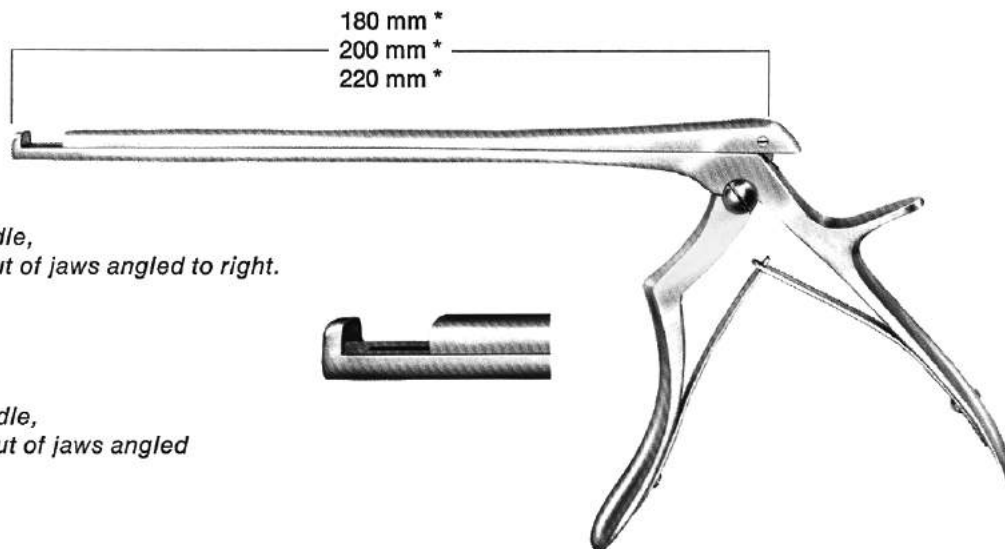

K-3120/16 To K-3124/76







Kerrison Rongeurs, large handle, up-cutting, 90° angled jaws, cut of jaws angled to right.

K-3130/16 To K-3132/66

Kerrison Rongeurs, small handle, up-cutting, 90° angled jaws, cut of jaws angled to right.

K-3140/16 To K-3142/66

Kerrison Rongeurs, Ferris-Smith ring handle, up-cutting, 90° angled jaws, cut of jaws angled to right.

width x height mm	Large Kerrison			Small Kerrison		Ferris-Smith-Kerrison	
	180 mm *	200 mm *	220 mm *	180 mm *	200 mm *	180 mm *	200 mm *
 2,5 x 2,5	K-3120/16	K-3122/16	K-3124/16	K-3130/16	K-3132/16	K-3140/16	K-3142/16
 2,0 x 3,0	K-3120/26	K-3122/26	K-3124/26	K-3130/26	K-3132/26	K-3140/26	K-3142/26
<i>with ejector</i>							
 3,0 x 4,0	K-3120/36	K-3122/36	K-3124/36	K-3130/36	K-3132/36	K-3140/36	K-3142/36
 4,0 x 5,0	K-3120/46	K-3122/46	K-3124/46	K-3130/46	K-3132/46	K-3140/46	K-3142/46
 5,0 x 5,0	K-3120/56	K-3122/56	K-3124/56	K-3130/56	K-3132/56	K-3140/56	K-3142/56
 6,0 x 5,0	K-3120/66	K-3122/66	K-3124/66	K-3130/66	K-3132/66	K-3140/66	K-3142/66
 7,0 x 6,0	K-3120/76	K-3122/76	K-3124/76				

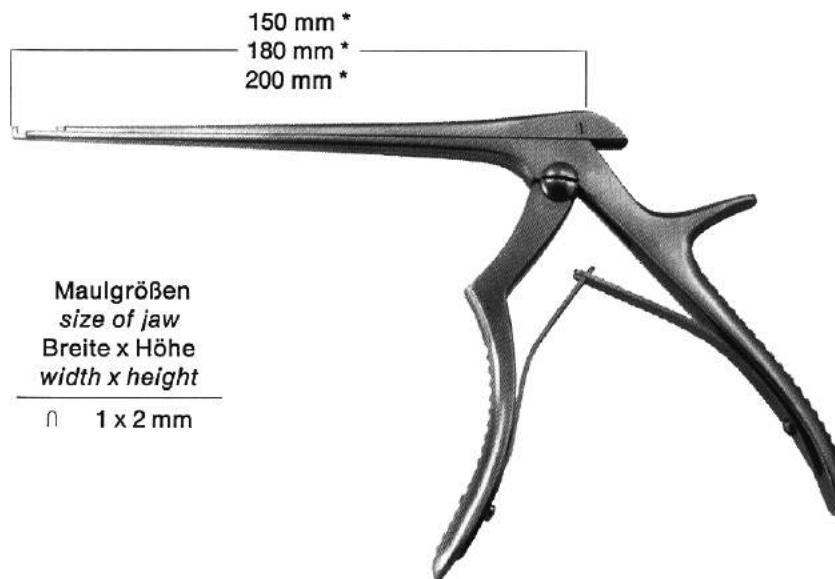

			<i>length</i>		
			150 mm *	180 mm *	200 mm *

K-3136/11 To K-3136/31

*Micro Kerrison Rongeurs,
 small handle, up-cutting, 90° angled jaws.*



K-3136/11	K-3136/21	K-3136/31
-----------	-----------	-----------

K-3136/12 To K-3136/32

*Micro Kerrison Rongeurs,
 small handle, up-cutting, 50° angled jaws.*



K-3136/12	K-3136/22	K-3136/32
-----------	-----------	-----------

K-3136/13 To K-3136/33

*Micro Kerrison Rongeurs,
 small handle, down-cutting, 90° angled jaws.*



K-3136/13	K-3136/23	K-3136/33
-----------	-----------	-----------

K-3136/14 To K-3136/34

*Micro Kerrison Rongeurs,
 small handle, dow-cutting, 50° angled jaws.*



K-3136/14	K-3136/24	K-3136/34
-----------	-----------	-----------

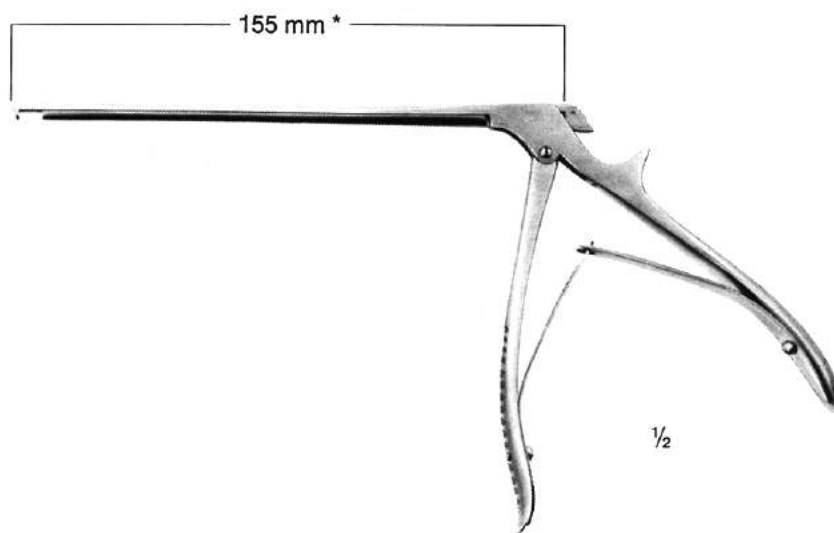

K-3139/1

*Pediatric Laminectomy Rongeur,
 up-cutting, 90° angled jaws,
 2.5 x 2 mm, 155 mm long.**



K-3139/2

*Pediatric Laminectomy Rongeur,
 down-cutting, 90° angled jaws,
 2.5 x 2 mm, 155 mm long.**



K-3106/1 To K-3106/3
Hajek-Kofler Rongeurs,
*up-cutting, 140 mm long.**

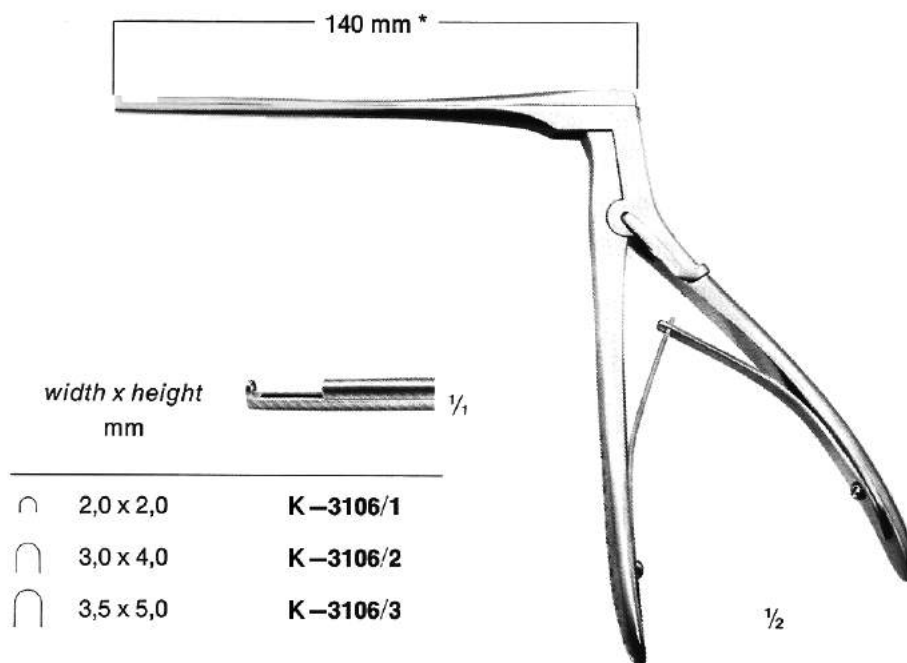

K-3108/1 To K-3108/3
Hajek-Kofler Rongeurs,
*down-cutting, 140 mm long.**

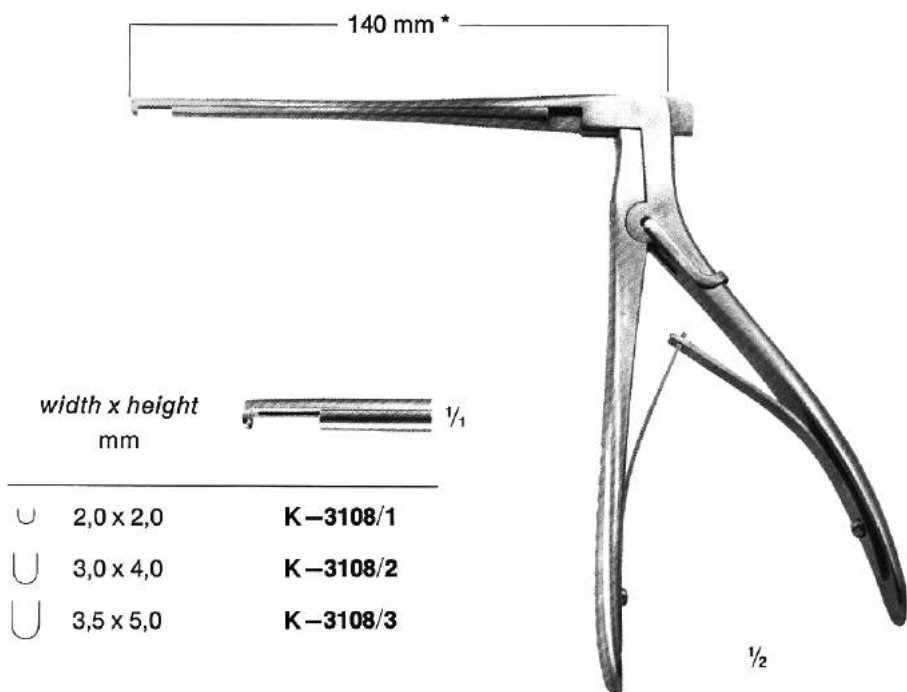

K-3160
Richter Rongeur, up-cutting,
*4.5 x 5 mm, jaws angled 75°, 150 mm long.**

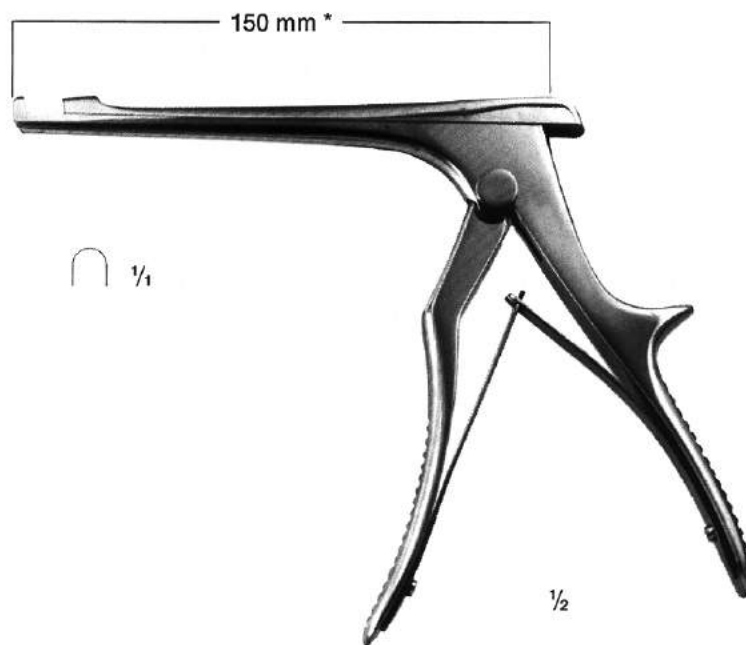

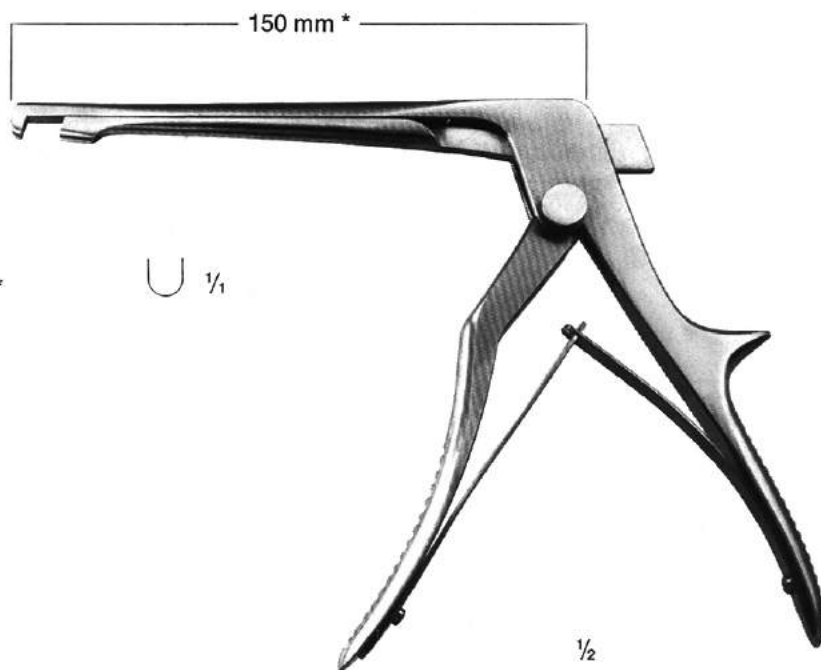

K-3162
Richter Rongeur, down-cutting,
*4.5 x 5 mm, jaws angled 75°, 150 mm long.**

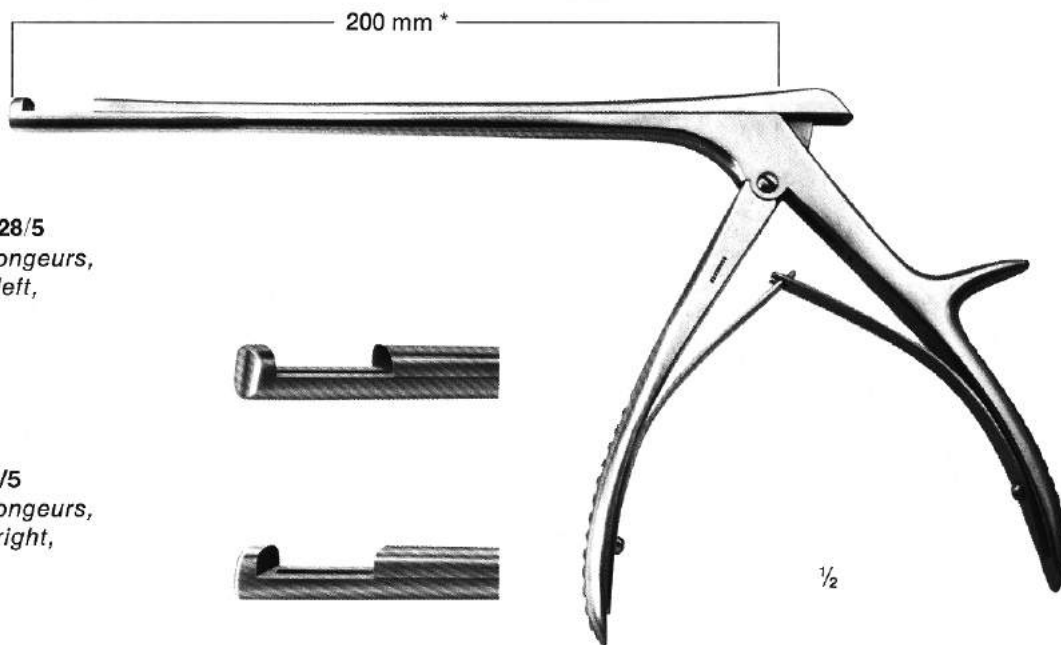



K-3228/2 To K-3228/5
 Whitcomb-Kerrison Rongeurs,
 cut of jaws angled to left,
 200 mm long.*

K-3230/2 To K-3230/5
 Whitcomb-Kerrison Rongeurs,
 cut of jaws angled to right,
 200 mm long.*

Size of jaw width x height mm	curved to left Art.-Nr.	curved to right Art.-Nr.
 2,0 x 3,0	K -3228/2	K -3230/2
 3,0 x 4,0	K -3228/3	K -3230/3
 5,0 x 5,0	K -3228/5	K -3230/5

without ejector

with ejector

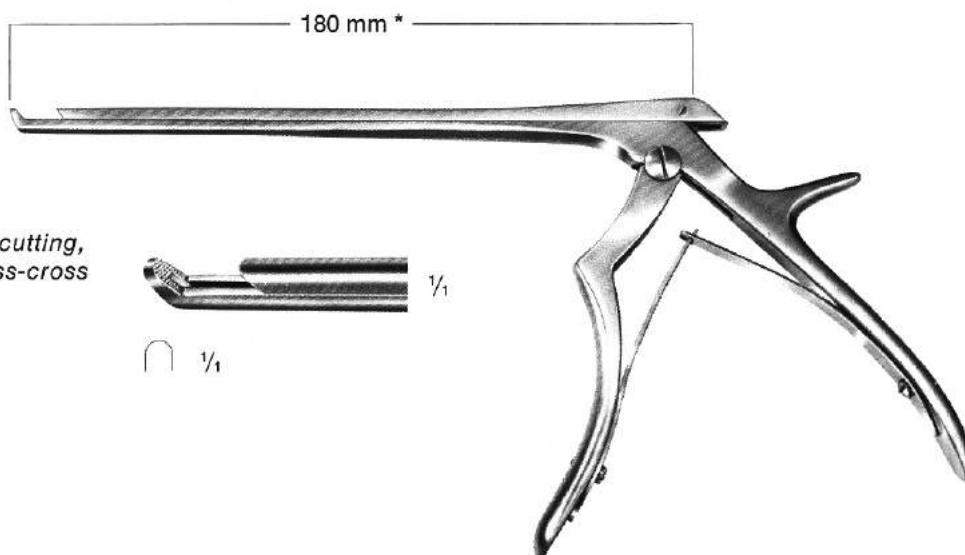

K-3240
 Link Hemostatic Rongeur, non-cutting,
 3.5 x 4 mm jaws angled 50°, criss-cross
 serrated, 180 mm long.*

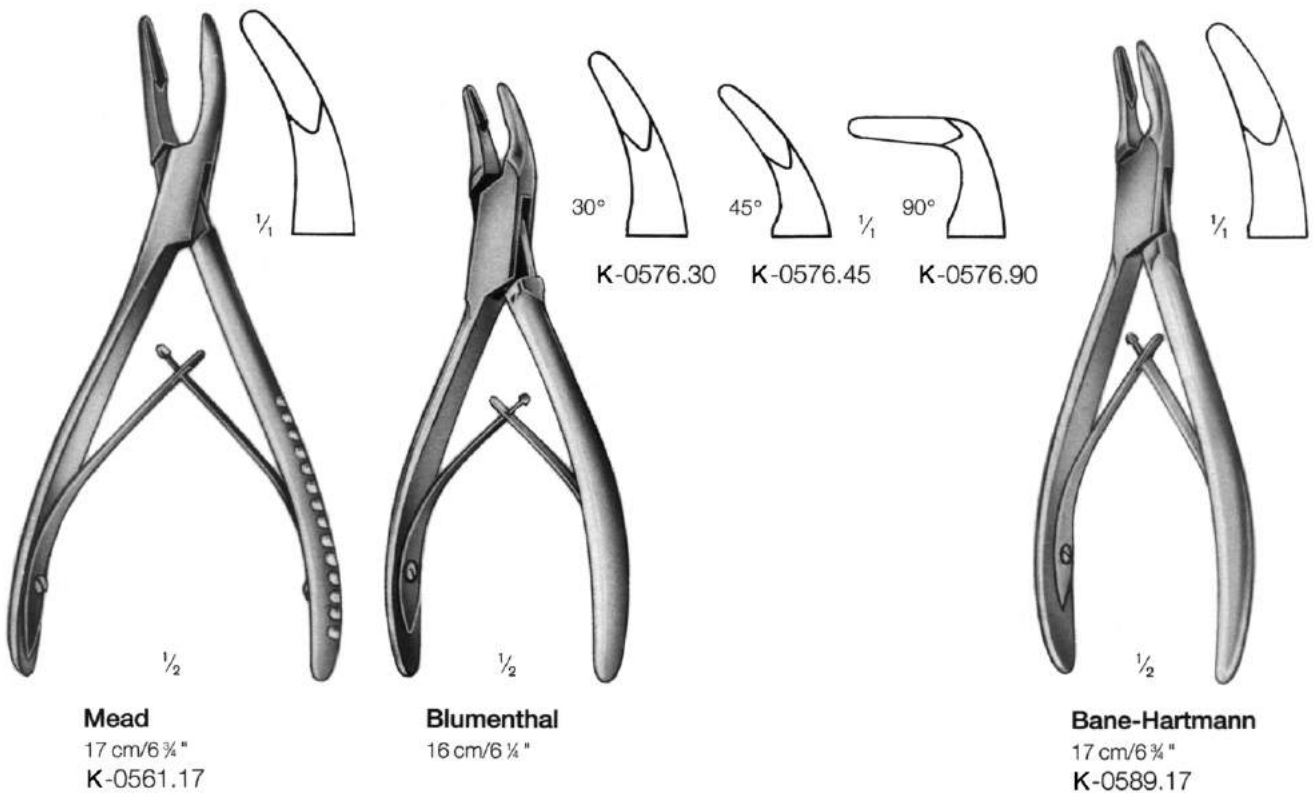
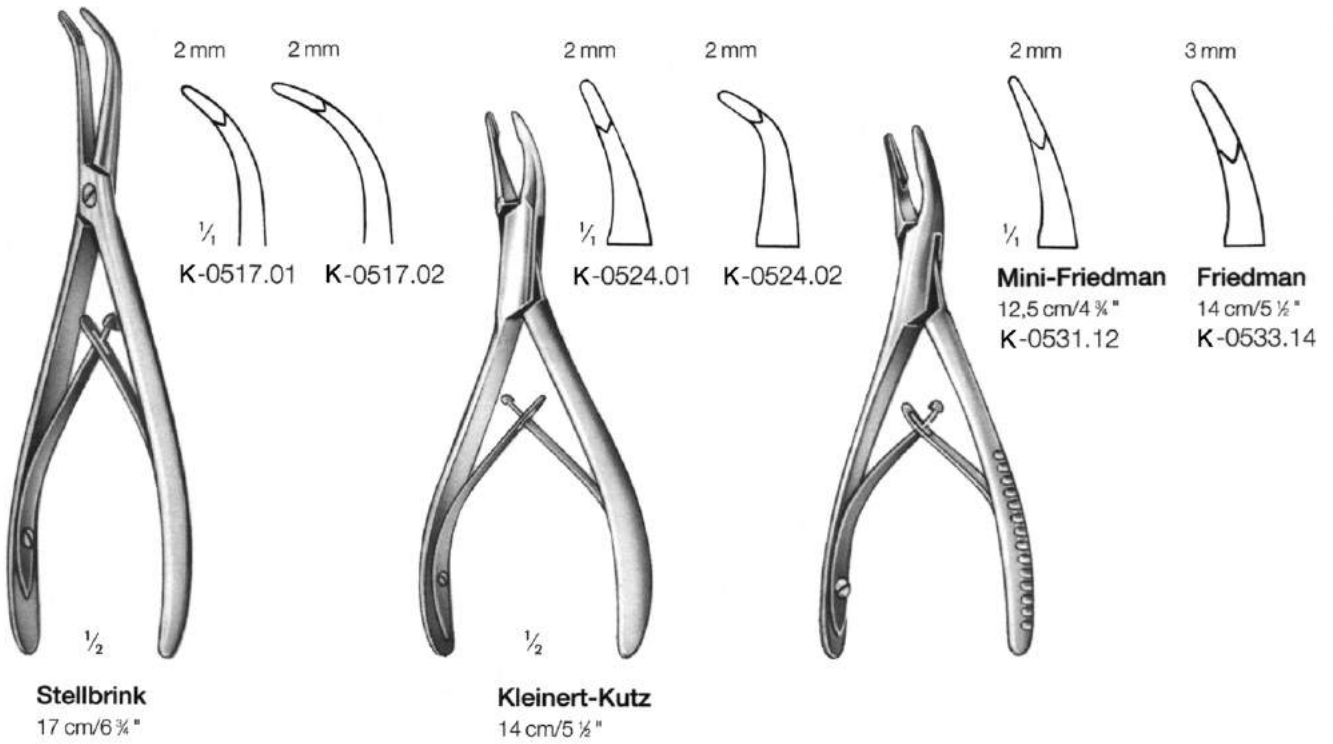

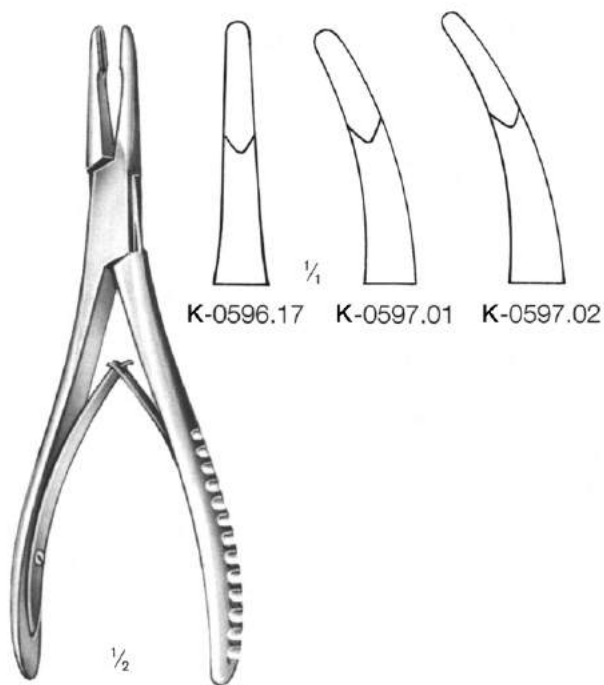

Jansen
 17 cm/6 3/4"



Jansen
 18 cm/7"
 K-0611.18

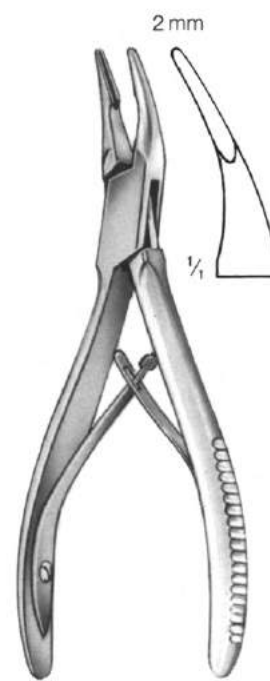

Beyer
 17 cm/6 3/4"
 K-0627.02

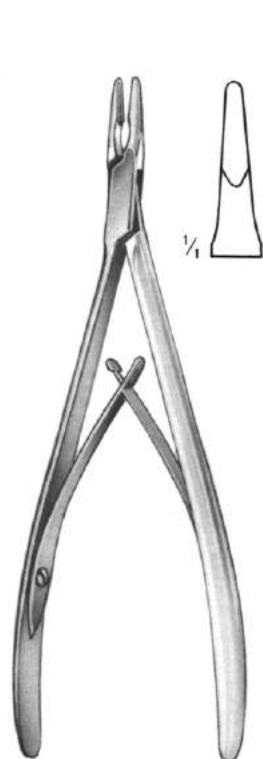

Lempert
 19 cm/7 1/2"
 K-0636.19

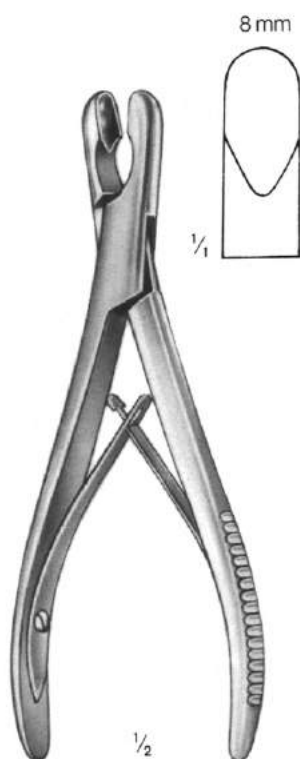

Luer
 18 cm/7"
 K-0650.18

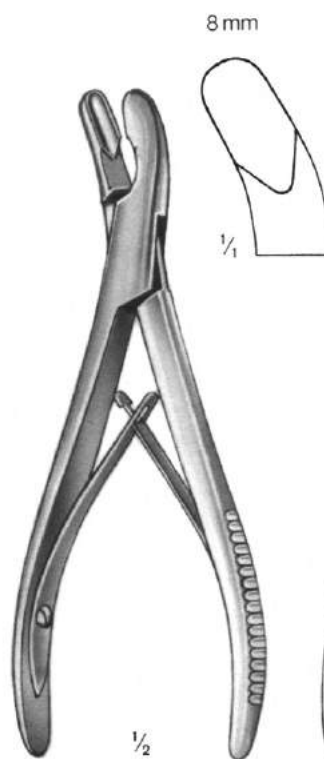

Luer
 18 cm/7"
 K-0651.18

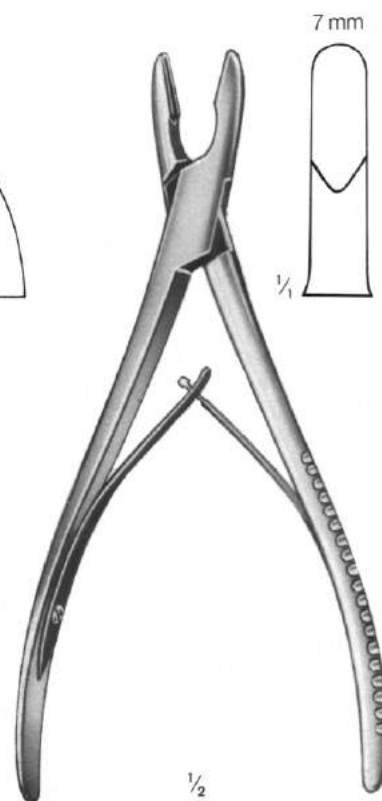

Adson
 20 cm/8"
 K-0670.20

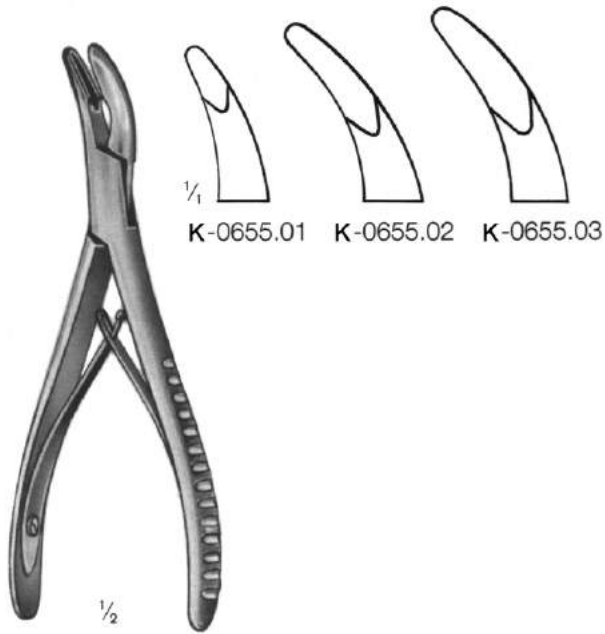

Luer
 15 cm/6"

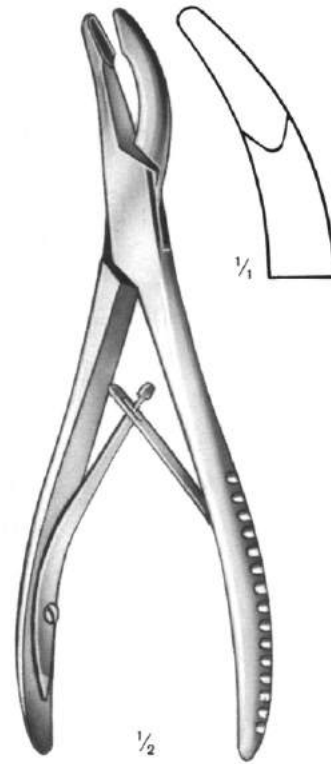

Olivecrona
 20 cm/8"
 K-0677.20

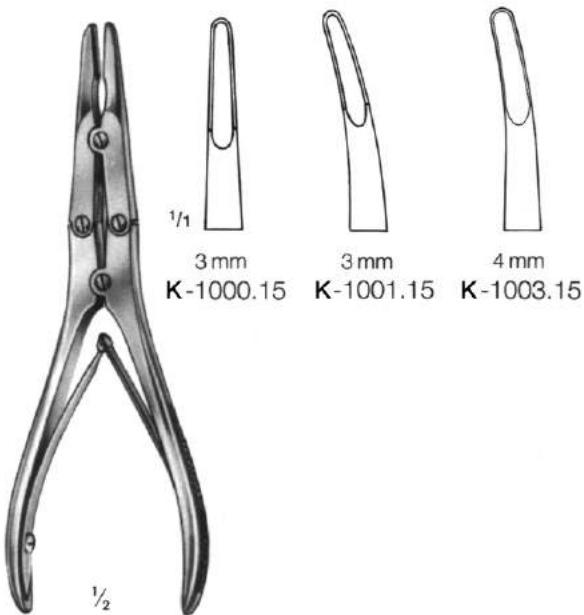

Böhler (Ruskin-Mini)
 15 cm/6"



Beyer
 18 cm/7"
 K-1011.18



Zaufal-Jansen
 18 cm/7"
 K-1013.18



19 cm/7 ½"



24 cm/9 ½"



24 cm/9 ½"



straight



light curve



strong curve

	straight		light curve		strong curve	
	3 mm	4 mm	3 mm	4 mm	3 mm	4 mm
Smith-Peterson						
19 cm/7 ½"	K-1019.03	K-1019.04	K-1019.13	K-1019.14	K-1019.23	K-1019.24
24 cm/9 ½"	K-1024.03	K-1024.04	K-1024.13	K-1024.14	K-1024.23	K-1024.24
Fulton	5 mm	6 mm	5 mm	6 mm	5 mm	6 mm
19 cm/7 ½"	K-1019.05	K-1019.06	K-1019.15	K-1019.16	K-1019.25	K-1019.26
24 cm/9 ½"	K-1024.05	K-1024.06	K-1024.15	K-1024.16	K-1024.25	K-1024.26



Mayfield
 18,5 cm/7 1/4"
 K-1035.18



Marquardt
 20 cm/8"
 K-1037.20

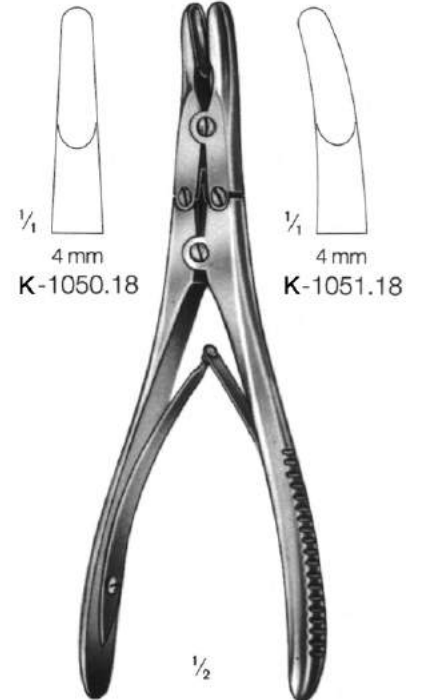

Ruskin
 18 cm/7"



Röttgen-Ruskin
 24 cm/9 1/2"
 K-1055.24

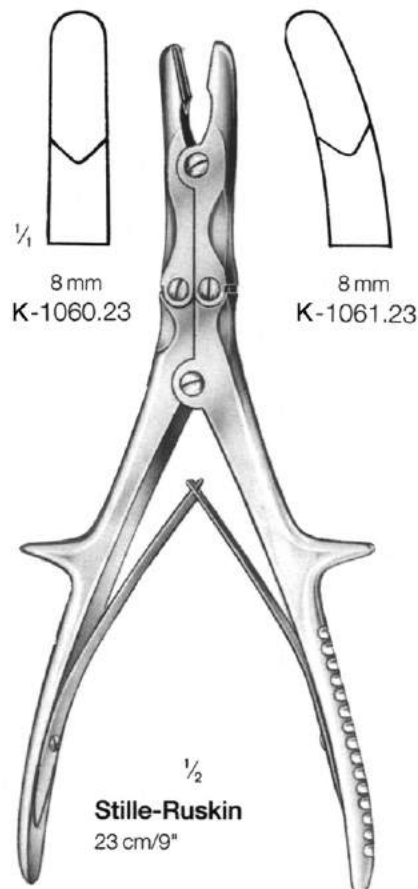

Stille-Ruskin
 23 cm/9"



Stille-Luer (Duckbill)
 23 cm/9"
 K-1065.23

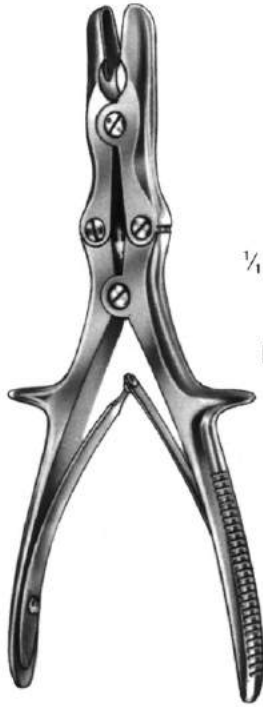

Stille-Luer

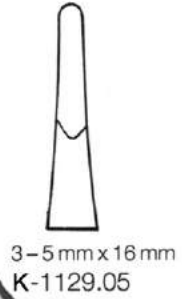
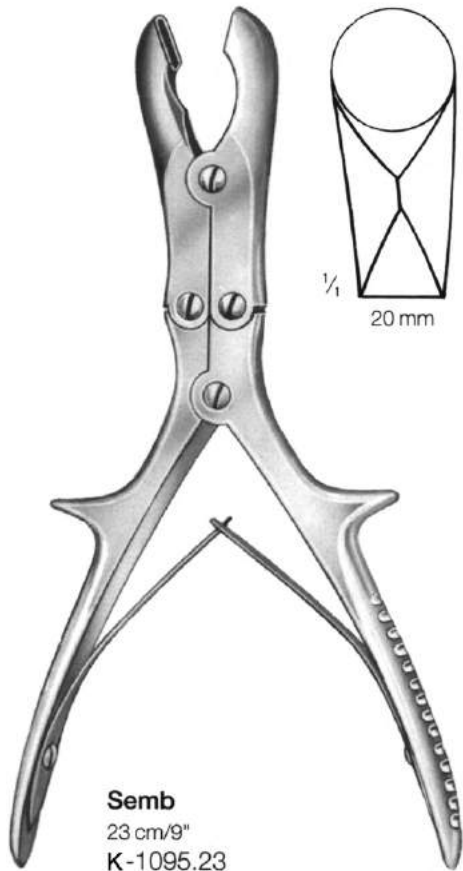
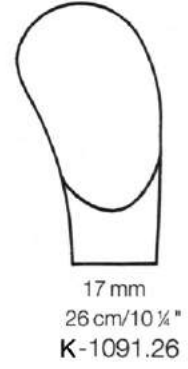
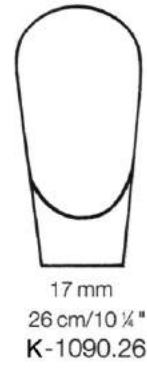
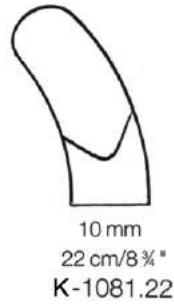
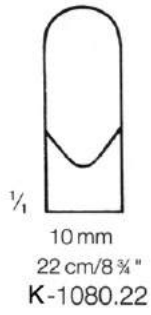

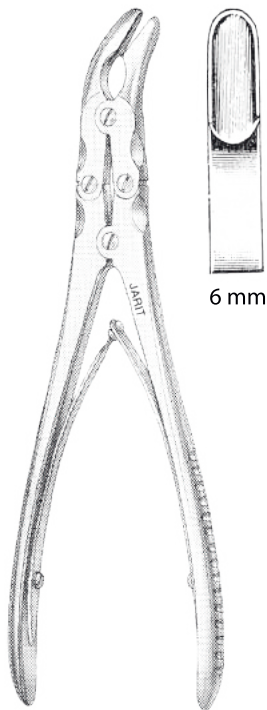

Ruskin-Duckbill
18 cm/7.25"
K-1105.18



Echlin (Duckbill)
23 cm/9"

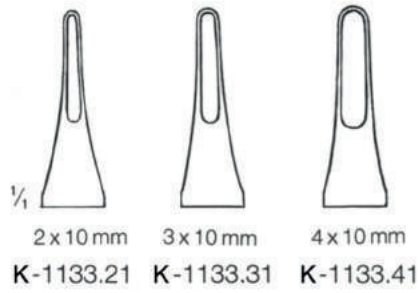

Frykholm
23 cm/9"
K-1135.23



Cottle-Kazanjian
 19 cm/7 1/2"
 K-0100.19



14 cm/5 1/2"



Littauer-Liston
 15,5 cm/6"
 K-0140.15

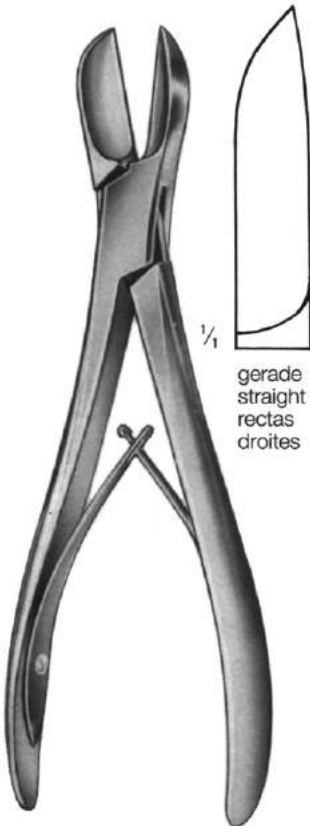

gerade
 straight
 rectas
 droites

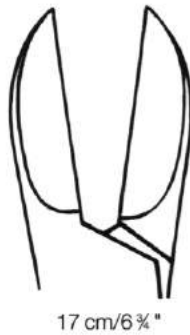

17 cm/6 3/4"

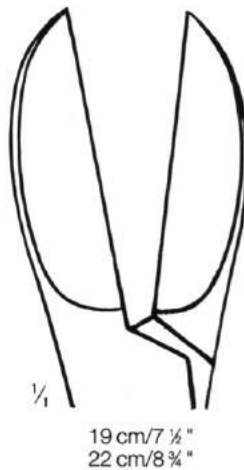

19 cm/7 1/2"
 22 cm/8 3/4"

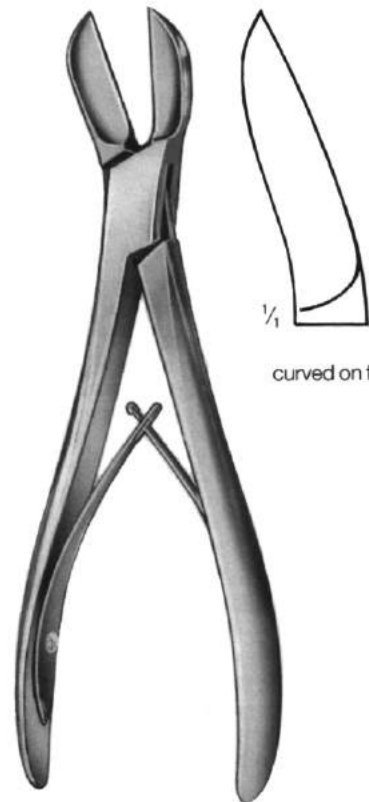

curved on flat

cm	inch.	Liston
14	5 1/2	K-0150.14
17	6 3/4	K-0150.17
19	7 1/2	K-0150.19
22	8 3/4	K-0150.22

cm	inch.	Liston
14	5 1/2	K-0151.14
17	6 3/4	K-0151.17
19	7 1/2	K-0151.19
22	8 3/4	K-0151.22

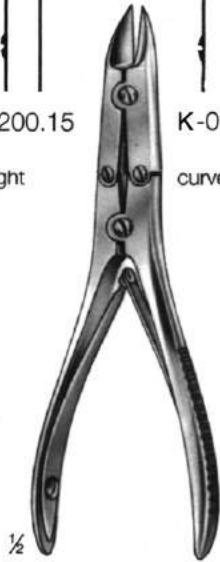
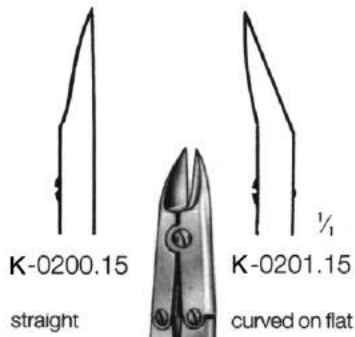

Böhler
15 cm/6"

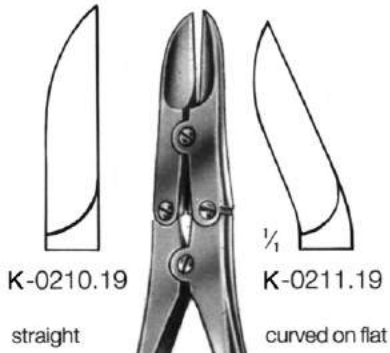

Ruskin-Liston
19 cm/7 1/2"



McIndoe
18 cm/7"
K-0223.17

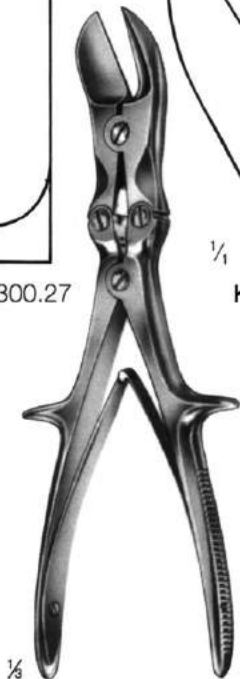
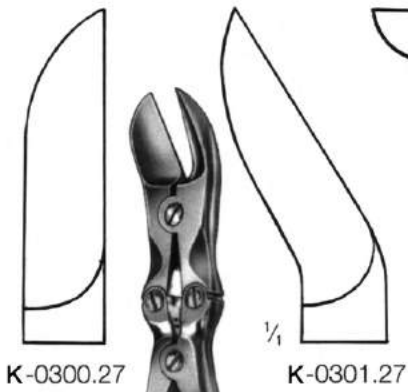

Stille-Liston
27 cm/10 3/4"

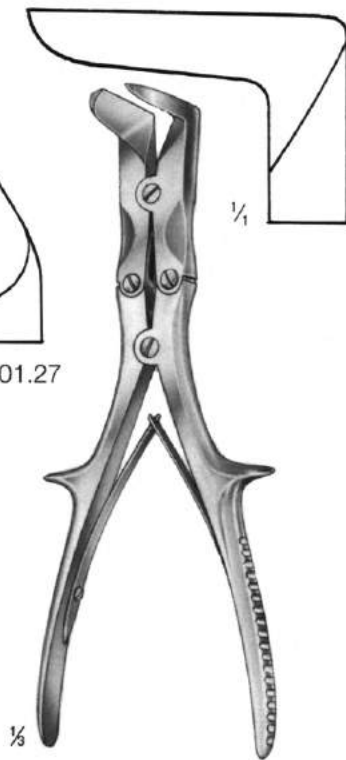

Stille-Liston
26 cm/10 1/4"
K-0303.26



Liston-Key-Horsley
27 cm/10 3/4"
K-0305.27

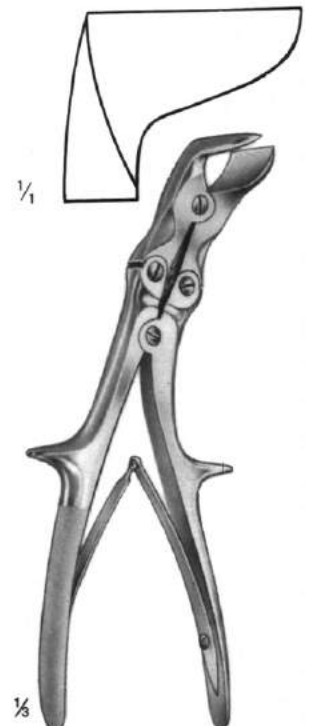

Semb
23 cm/9"
K-0307.23

Rib shears, sternum shears
Costotomes, cisaille à sternum
Costótomos, tijera de esternón

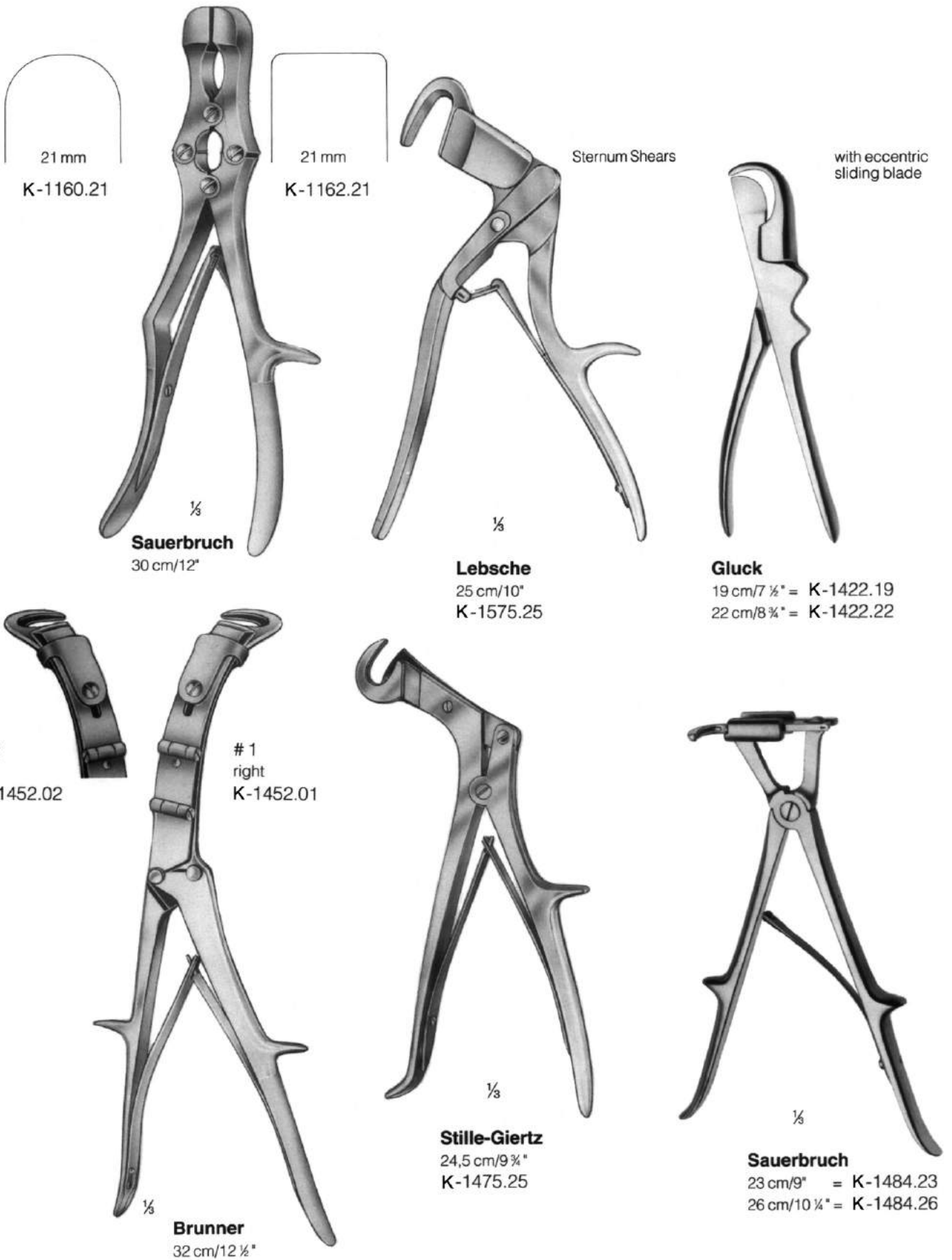

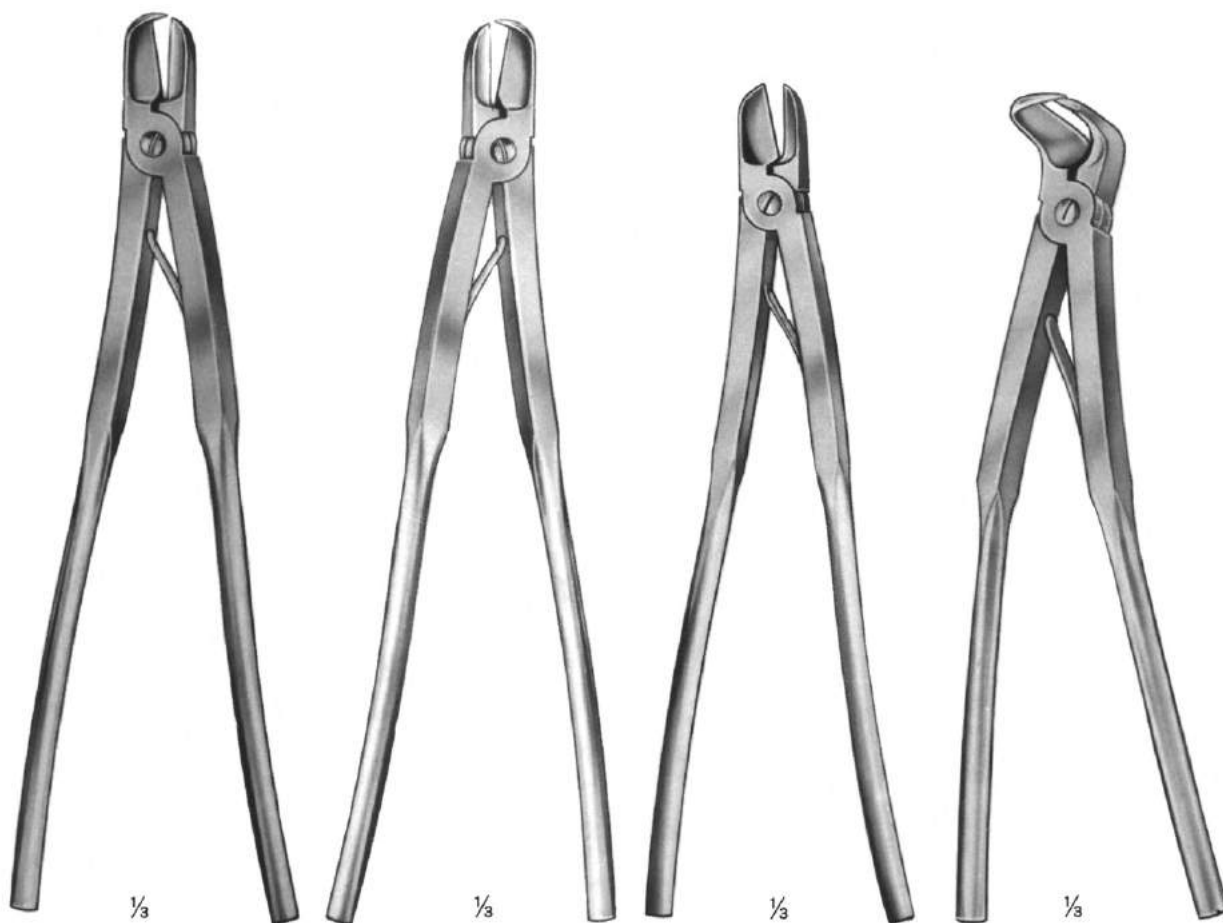

Coryllos-Bethune
35 cm/13 3/4"
K-1535.02

Coryllos-Bethune
35 cm/13 3/4"
K-1535.01

Bethune
34 cm/13 1/2"
K-1540.34

Roos
33 cm/13"
K-1543.33

Meniscus-and cartilage forceps
Pinces à ménisque et à cartilage
Pinzas para meniscos y para cartilagos

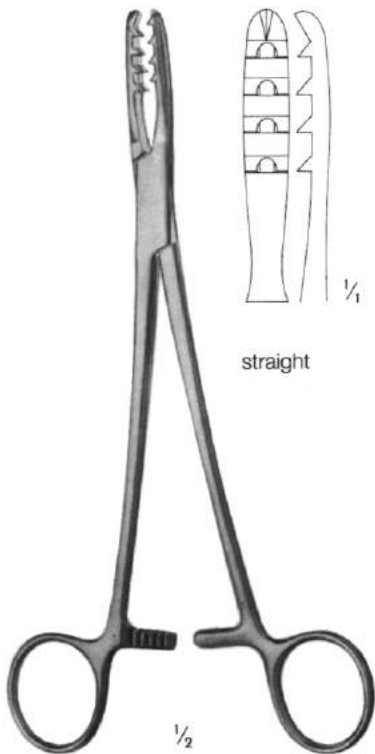

straight

Bircher-Ganske
 20 cm/8"
 K-2002.20

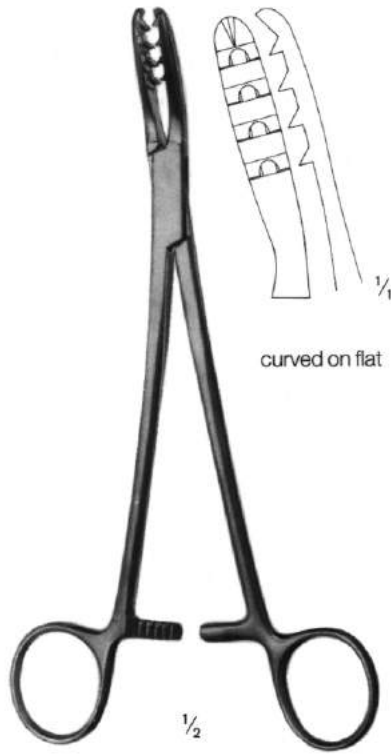

curved on flat

Bircher-Ganske
 20 cm/8"
 K-2003.20

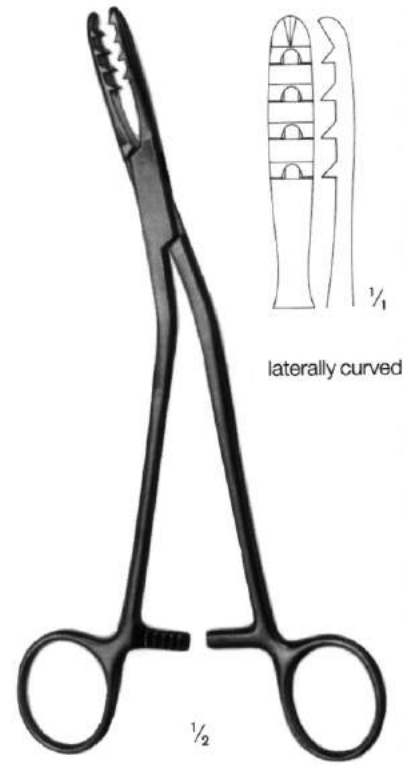

laterally curved

Bircher-Ganske
 20 cm/8"
 K-2005.20



Martin
 16 cm/6 1/4"
 K-2008.16



Martin
 19,5 cm/7 3/4"
 K-2008.19

Bone Holding Forceps

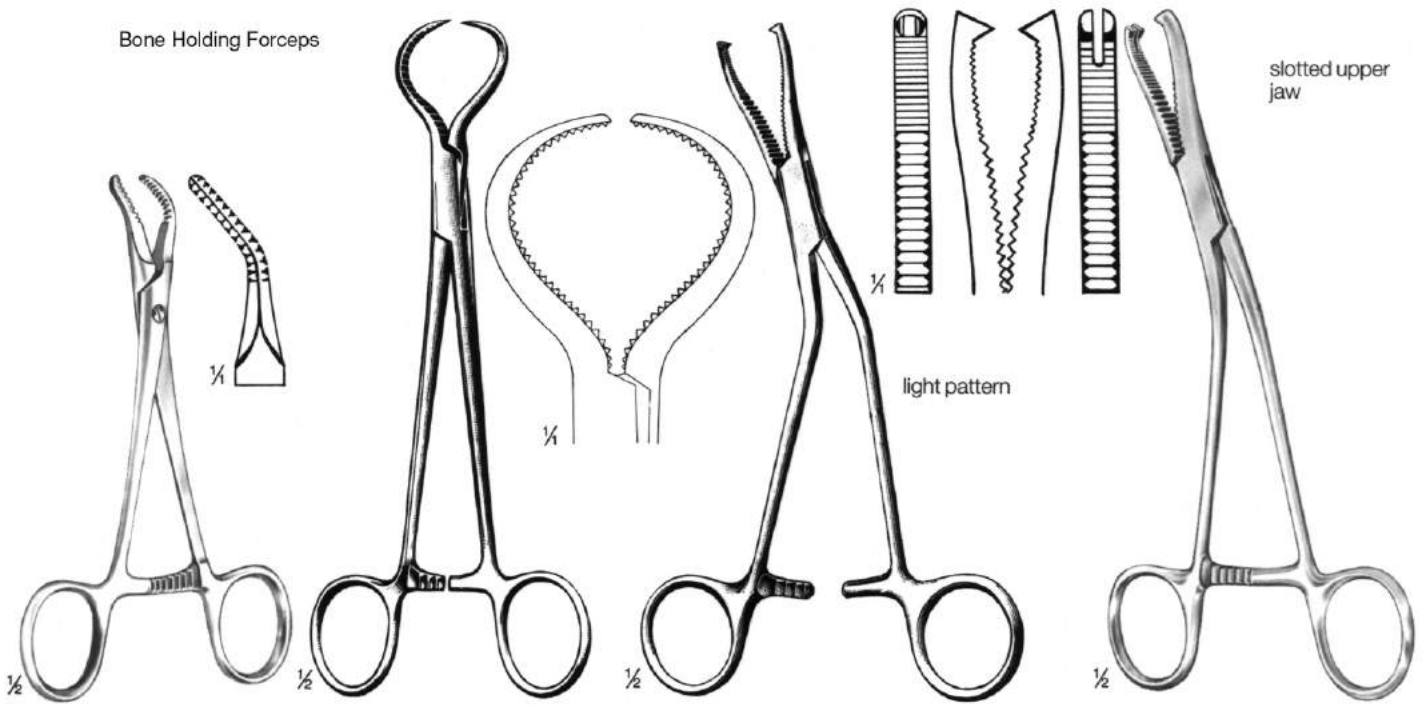

14 cm/5 1/2"
 K-2021.14

Lewin
 18 cm/7"
 K-2027.18

Dingman
 18,5 cm/7 1/4"
 K-2035.19

Dingman
 18,5 cm/7 1/4"
 K-2037.19

Reposition Forceps

Finger Reposition Forceps

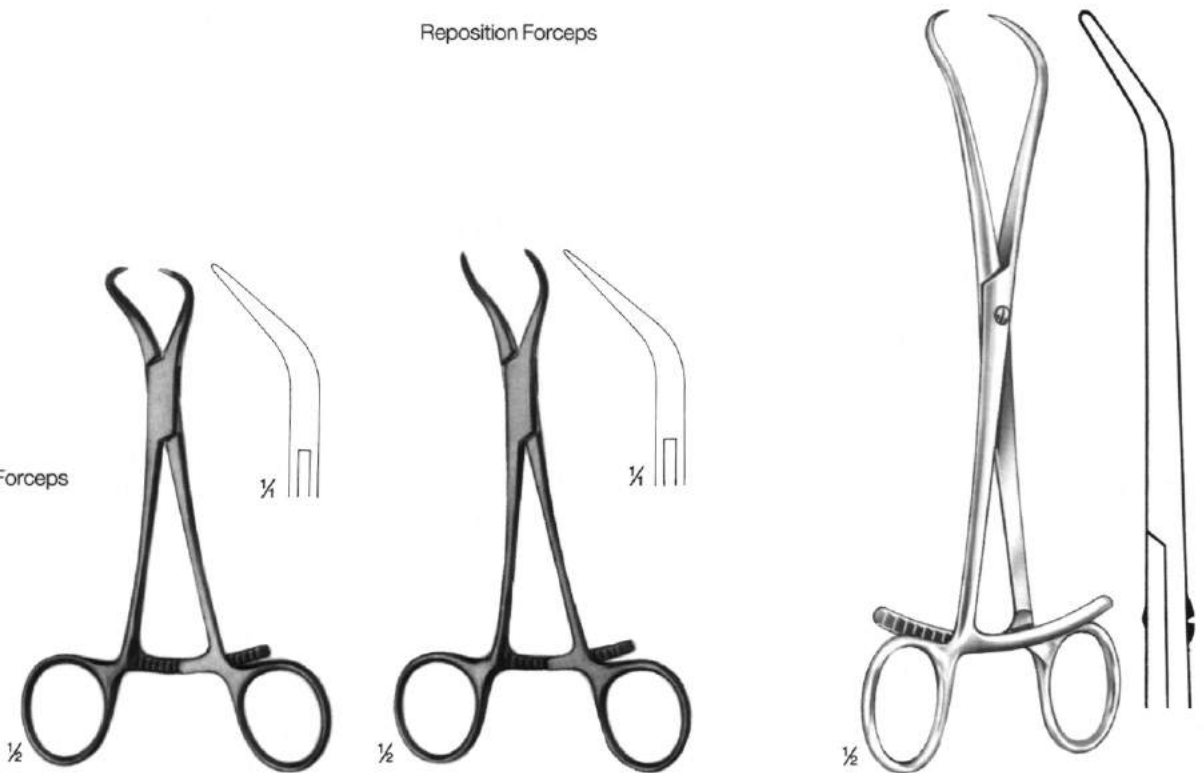

Apart
 13,5 cm/5 1/4"
 K-2041.13

14,5 cm/5 3/4"
 K-2043.14

20 cm/8"
 K-2051.20

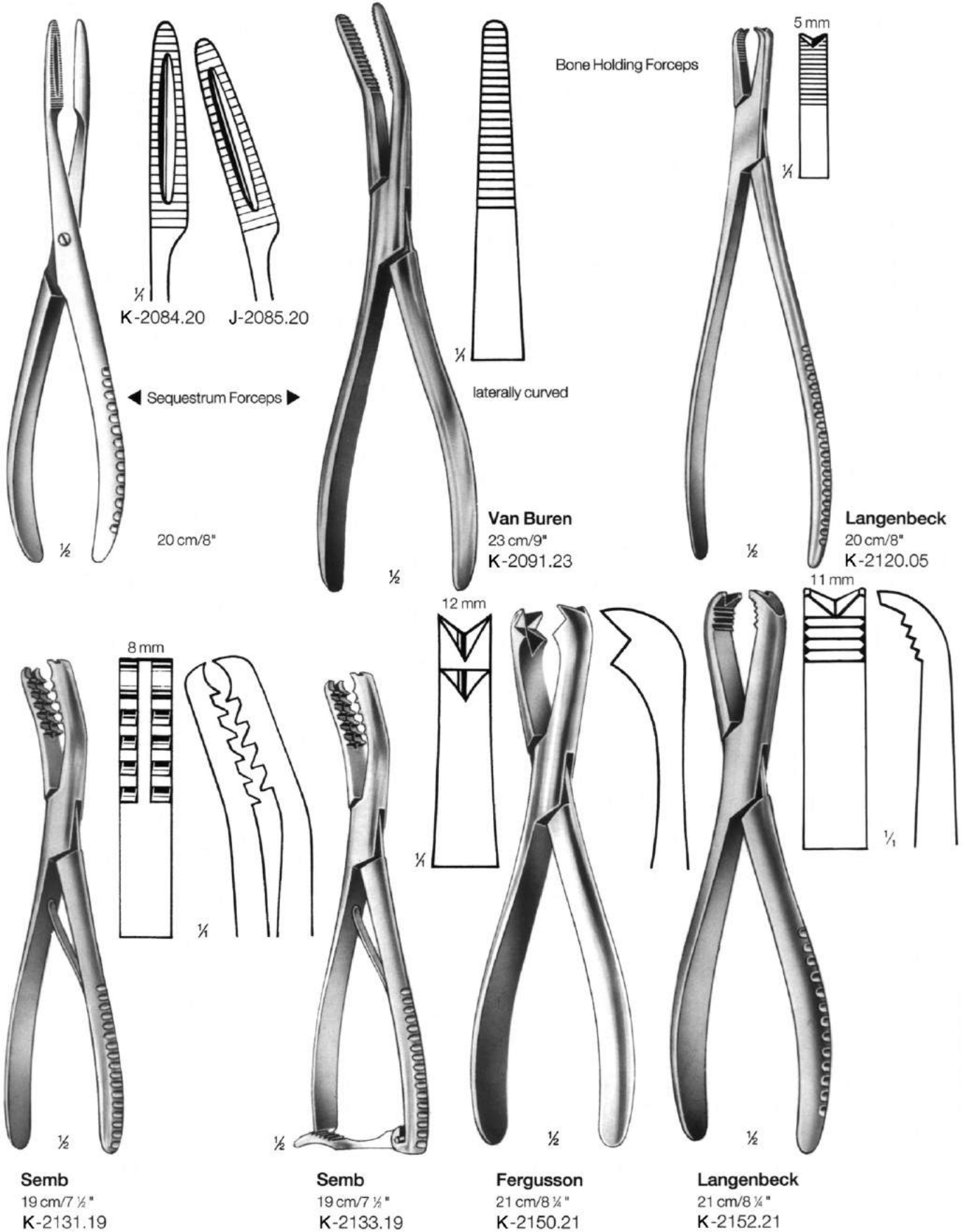

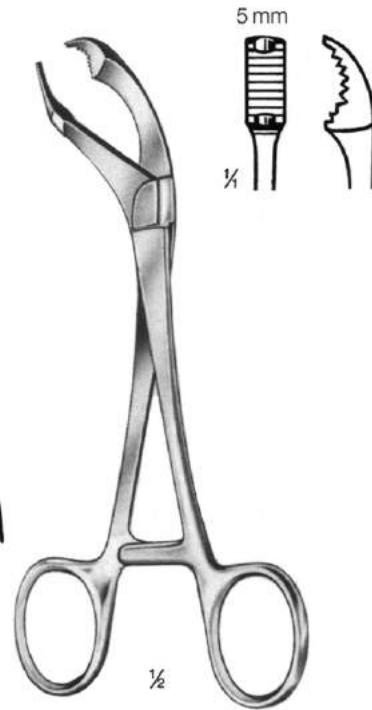
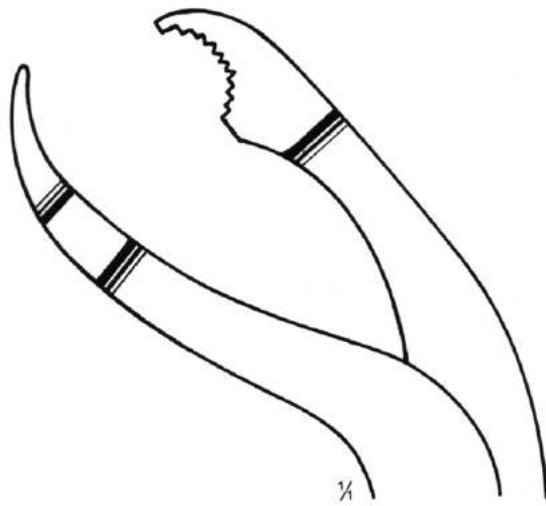

Verbrugge
17,5 cm/6 3/4"
K-2200.17

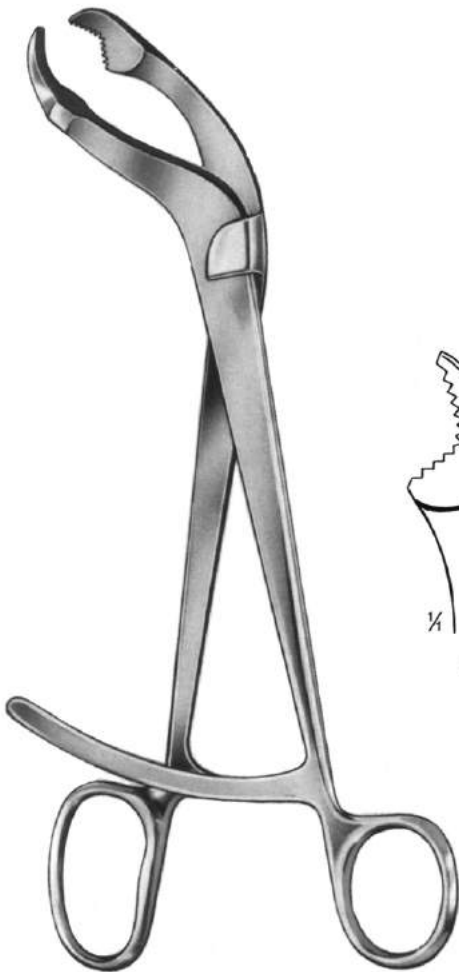

Verbrugge

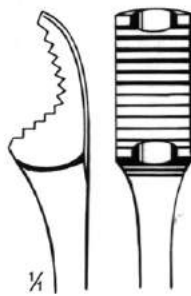

25 cm/10"
K-2200.25

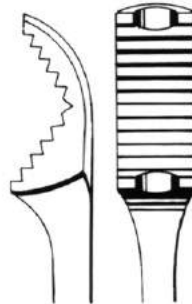

26 cm/10 1/2"
K-2200.26

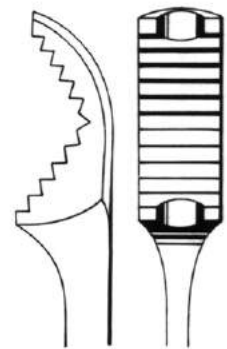

27 cm/11"
K-2200.27

**Bone holding forceps
Daviers
Pinzas para huesos**

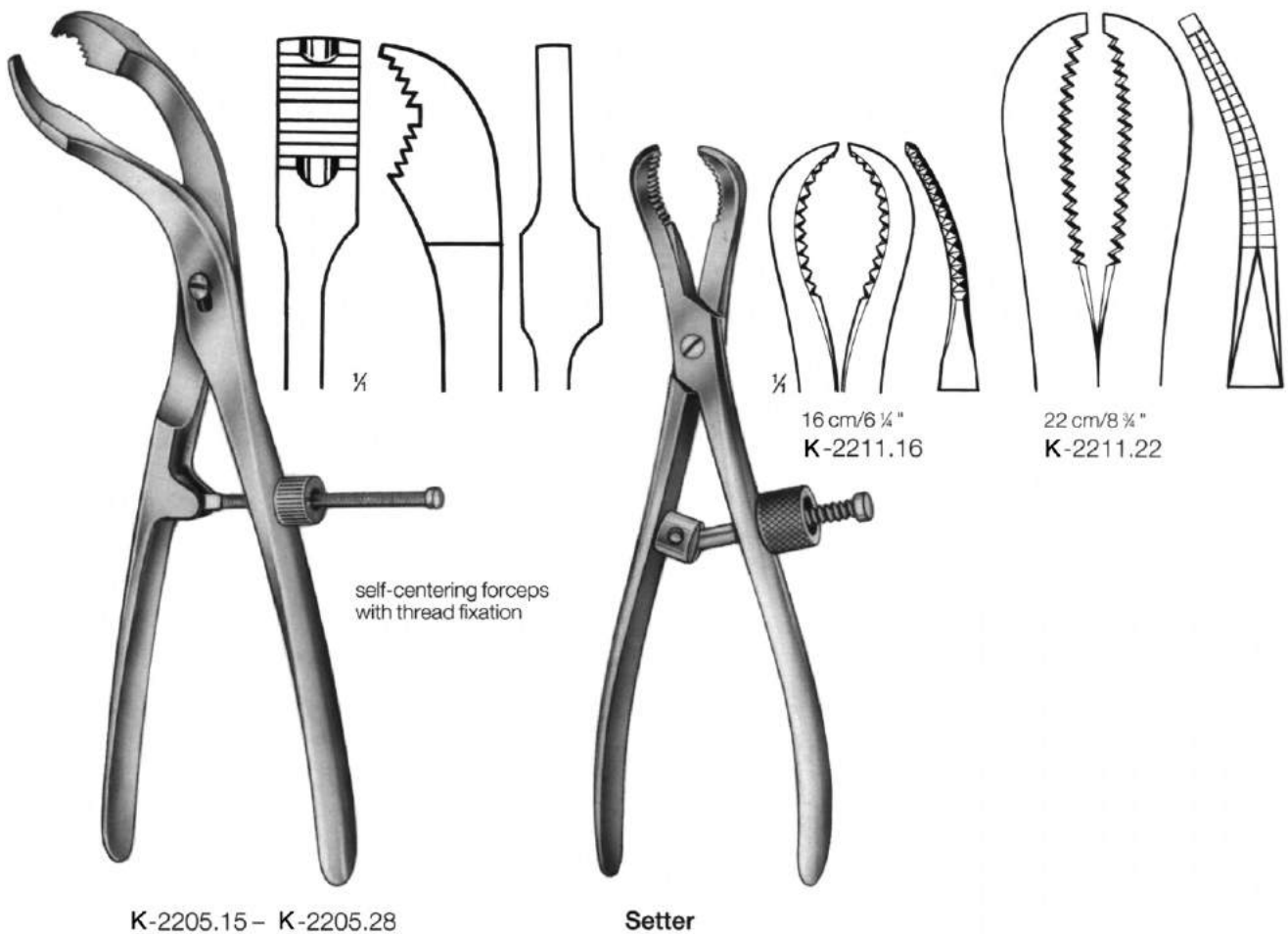
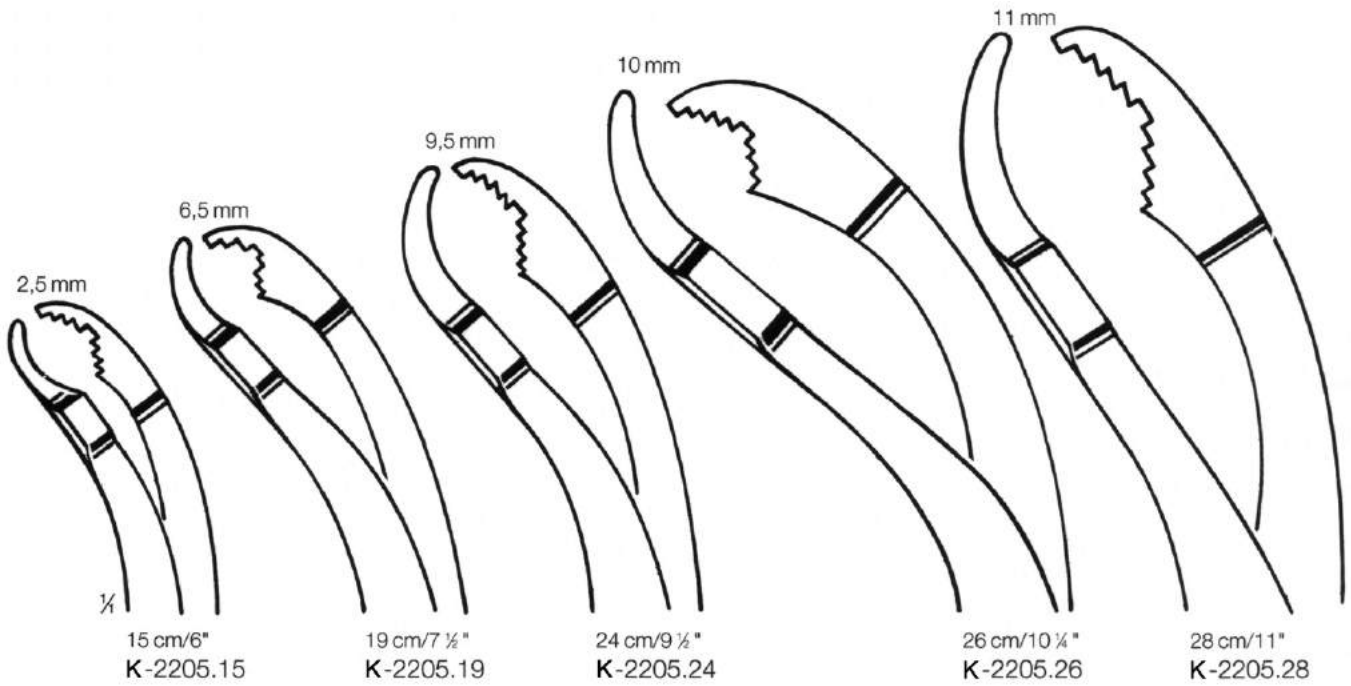

Bone holding forceps
Daviers
Pinzas para huesos

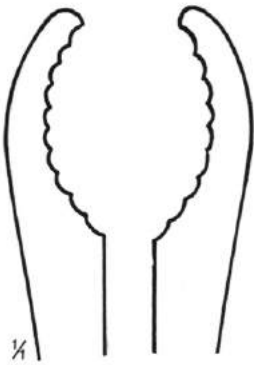

18 cm/7"
 K-2220.18

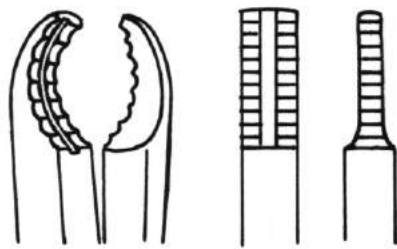

23 cm/9"
 K-2220.23

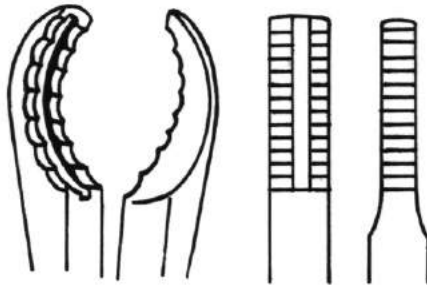

25 cm/10"
 K-2220.25

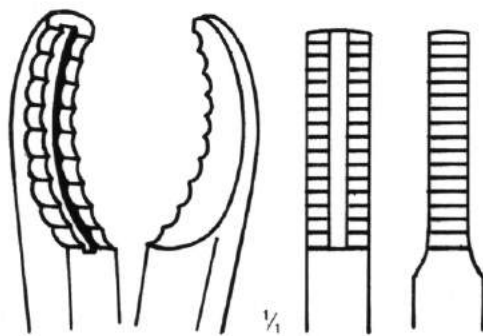

28 cm/11"
 K-2220.28



Ulrich

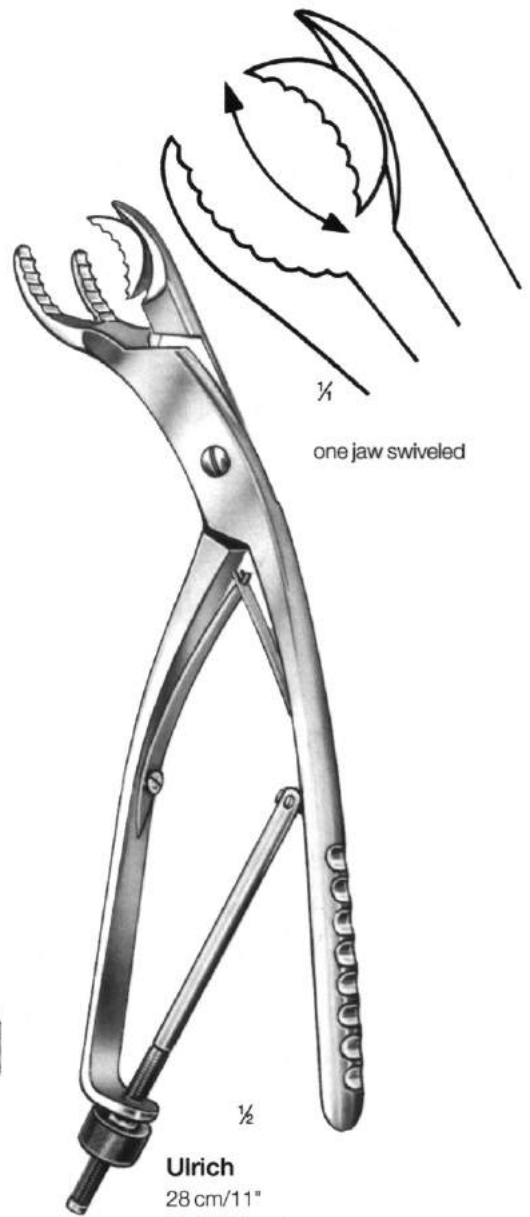

1/4
 one jaw swiveled

Ulrich
 28 cm/11"
 K-2223.28

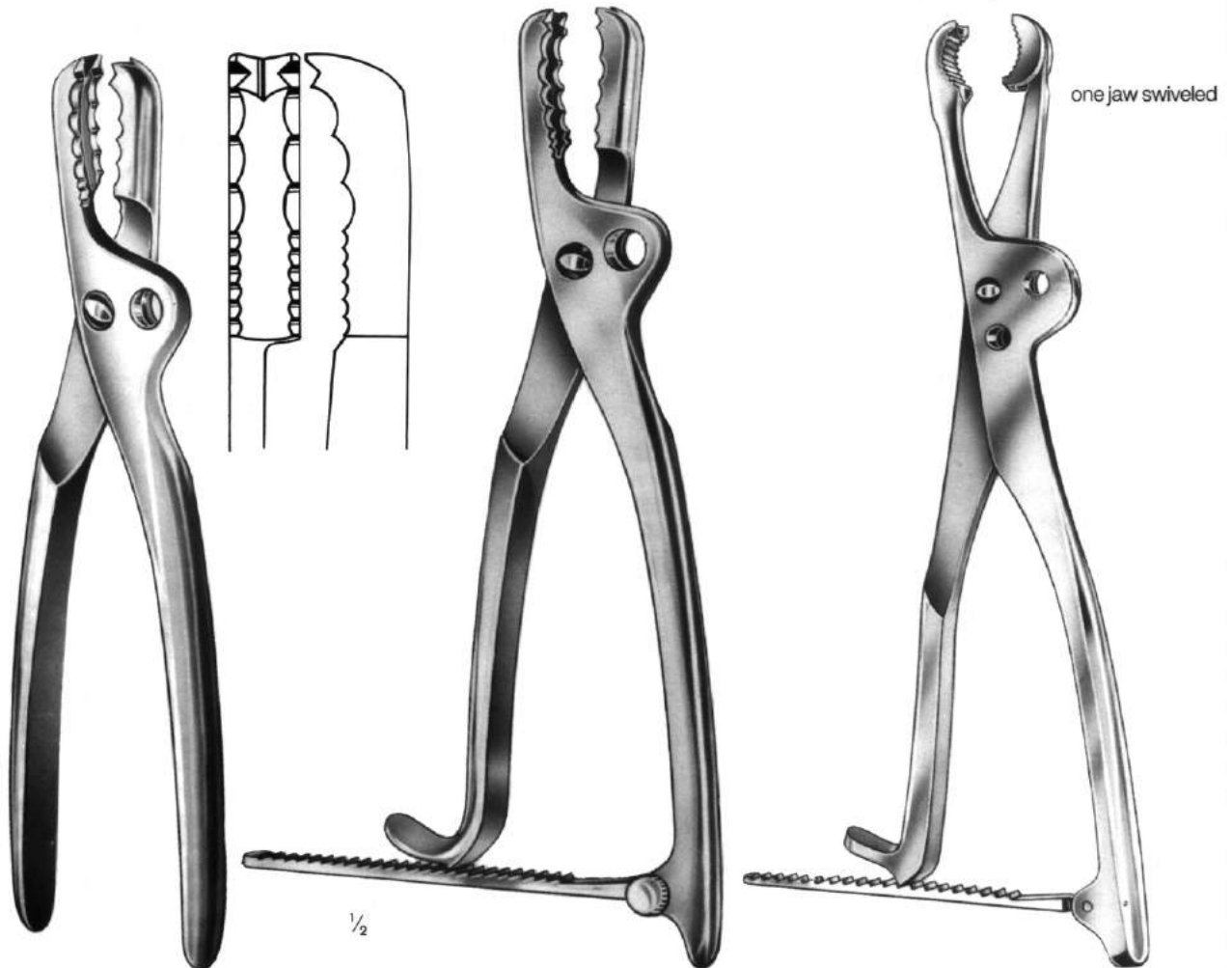
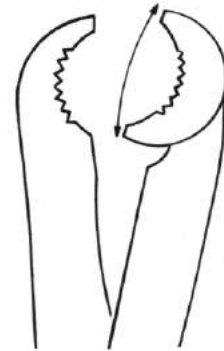

Farabeuf
K-2310.23 = 23 cm/9"
K-2310.23 = 26 cm/10 ¼"

Farabeuf-Lambotte
26 cm/10 ¼"
K-2315.26

Lambotte
K-2320.22 = 22 cm/8 ¾"
K-2320.27 = 27 cm/10 ½"
K-2320.30 = 30 cm/12"

**Bone holding forceps
Daviers
Pinzas para huesos**

without ratchet



with ratchet



		Kern	Kern
cm	in.		
14	5 ½"	K-2340.14	K-2342.14 (Baby-Kern)
22	8 ¾"	K-2340.22	K-2342.22

without ratchet



with ratchet



Lane

		cm	in.
K-2360.33		33	13
K-2360.43		43	17

Lane

K-2362.33
K-2362.43

Bone clamps, nail extracting forceps
Daviers, pince pour extraire les ongles
Pinzas porta-huesos, pinza para arrancar uñas

Traction bar (Turnbuckle)

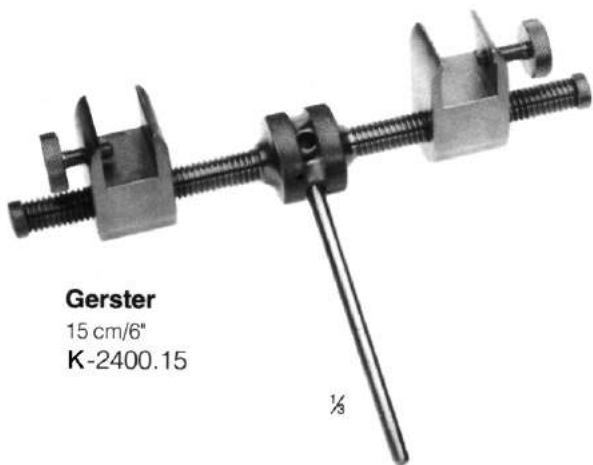

Gerster
 15 cm/6"
 K-2400.15

1/8



1/2

Lowman

cm	inch.	
12	4 3/4	K-2410.12
18	7	K-2410.18
20	8	K-2410.20
22	8 3/4	K-2410.22



1/2

Lowman-Hoglund

18 cm/7"
 K-2420.18



1/2

Lowman Modif.

cm	inch.	
12	4 3/4	K-2430.12
18	7	K-2430.18
20	8	K-2430.20

Nail extracting forceps



1/2



1/4

Radolf
 14 cm/5 1/2"
 K-2494.14



23 cm / 9"

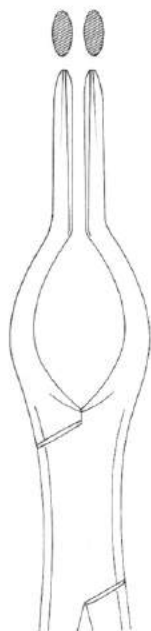

Universal

Cottle-Walsham
K-2523.00

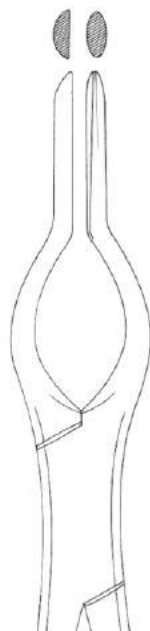

left

Walsham
K-2523.01

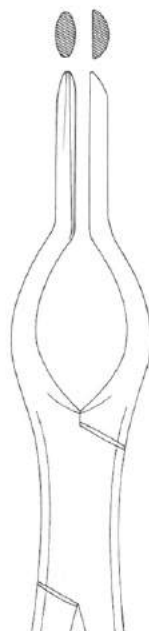

right

Walsham
K-2523.02



Asch
23 cm / 9"
K-2531.23

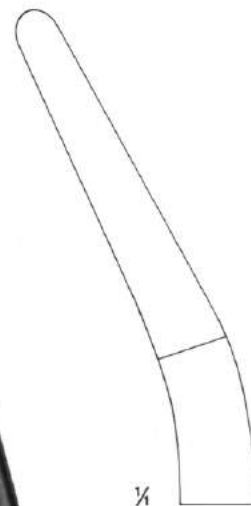

14 cm / 5 1/2"
K-3010.14



17 cm / 6 3/4"
K-3020.17



16 cm / 6 1/4"
K-3702.16

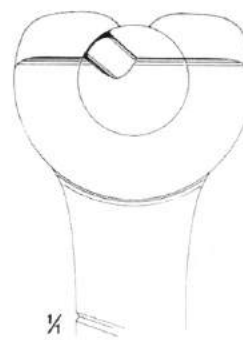

Wire Saws, braided, untearable



soldered

coarse, 4 wires twisted

fine, 6 wires twisted

cm inch.

30	12	K-1400.30	K-1404.30	K-1406.30
40	15½	K-1400.40	K-1404.40	K-1406.40
50	19¾	K-1400.50	K-1404.50	K-1406.50
60	23½	K-1400.60	K-1404.60	K-1406.60
70	27½	K-1400.70	K-1404.70	K-1406.70

Olivecrona

Gigli

Gigli

Hook Handle, turnable, for wire saws

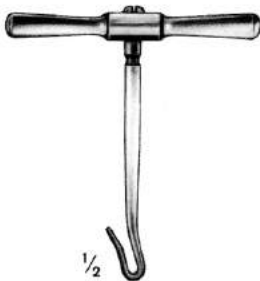

½

Gigli

K-1431.61

Conductors

malleable

elastic (flexible)



½

Lebsche

25 cm/10"

K-1420.25



½

DeMartel (Bailey)

33 cm/13"

K-1422.33

Handbohrapparate Bone Hand Drills Perforateurs a main



Brace
L-0510.90

Hudson
27 cm/10.8"
L-0510.00

Complete set including



9 mm
L-0514.09



14 mm
L-0514.14



16 mm
L-0514.16



22 mm
L-0514.22



14 mm
L-0530.14



Extension Piece
L-0512.09



16 mm
McKenzie
L-0519.17



2.4 mm
Adson
L-0532.24



13 mm
McKenzie
L-0518.13



16 mm
Derrico
L-0518.16

L-0510.90 , L-0514.09 , L-0514.14 , L-0514.16 , L-0514.22 & L-0512.09



Kirschner
L-2500.00
Complete



L-2502.00
Telescopic wire drill guide



L-2600.00
Complete



L-2602.00
Telescopic wire drill guide

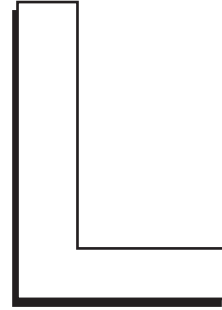

- Bone surgery, orthopedics
- Chirurgie osseuse, orthopédie
- Cirugía ósea, ortopedía

Plaster shear, plaster saw
Cisailles pour appareils plâtrés, scie à main à plâtres
Cizallas para vendajes enyesados, sierra de mano para yeso

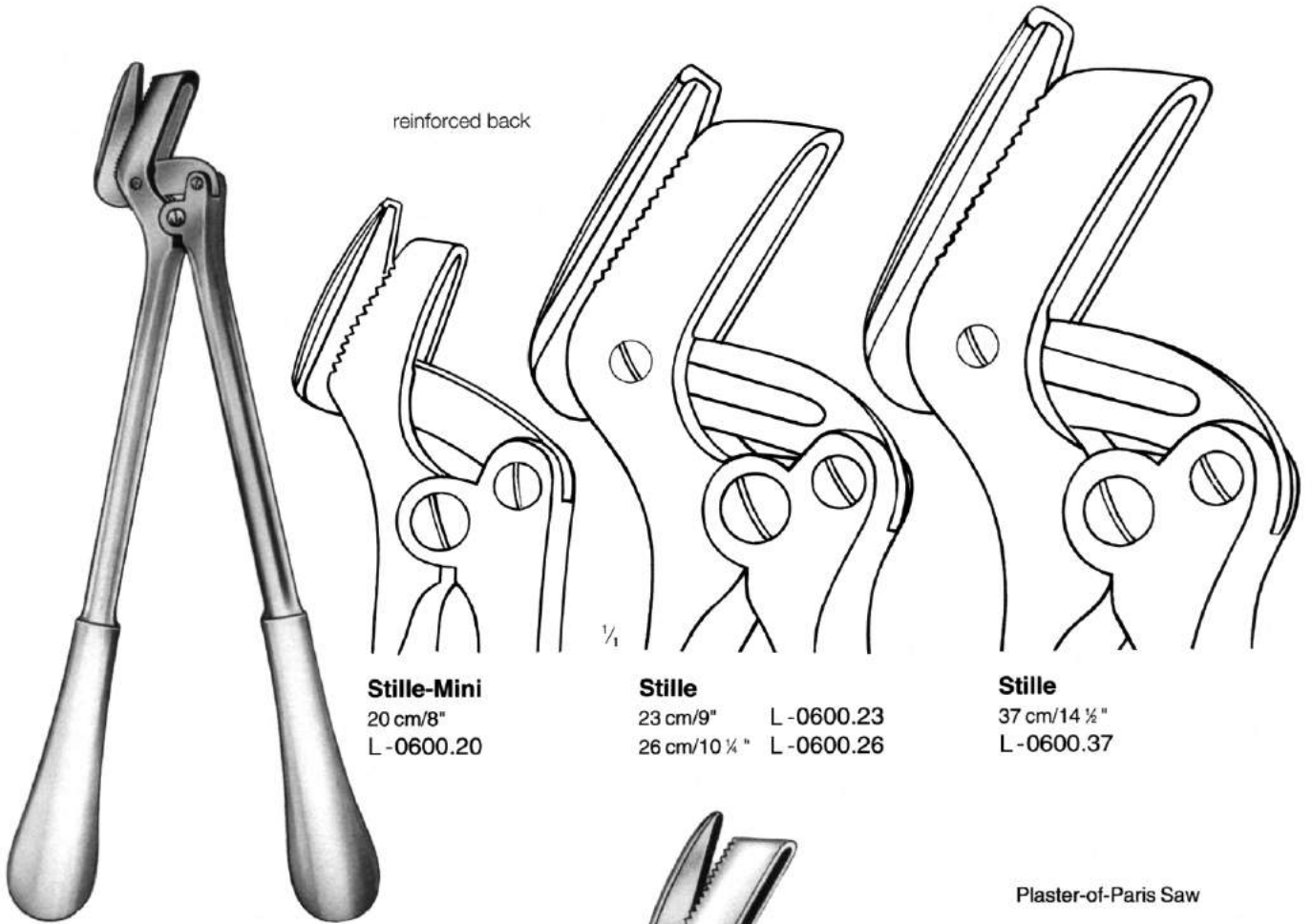

Stille-Mini
 20 cm/8"
 L-0600.20

Stille
 23 cm/9" L-0600.23
 26 cm/10 1/4" L-0600.26

Stille
 37 cm/14 1/2"
 L-0600.37

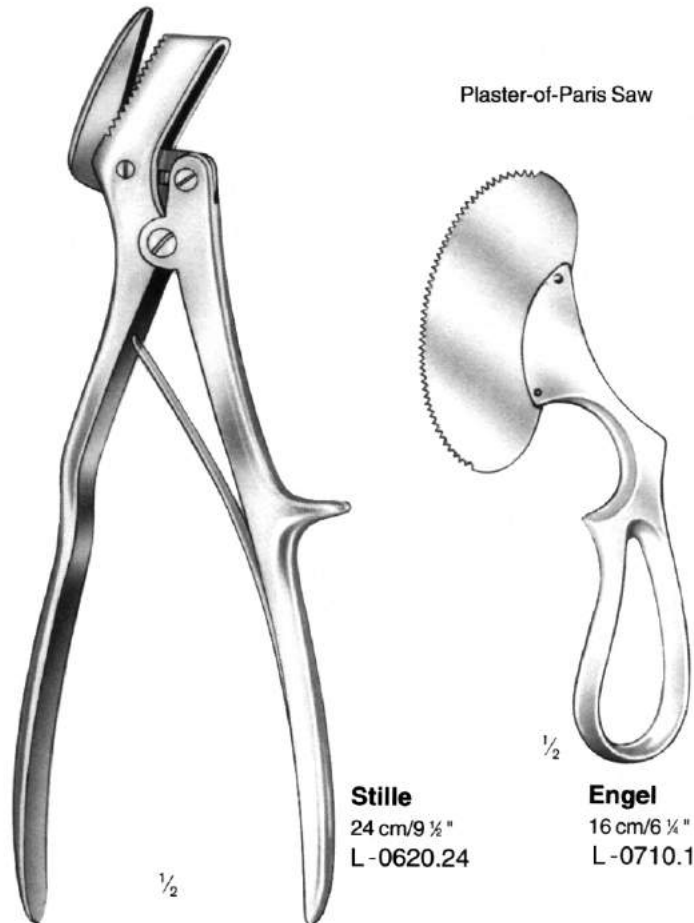

Stille
 24 cm/9 1/2"
 L-0620.24

Engel
 16 cm/6 1/4"
 L-0710.16



Haglund-Stille
 28 cm/11"
 L-0920.28



Hennig
 28 cm/11"
 L-0924.28

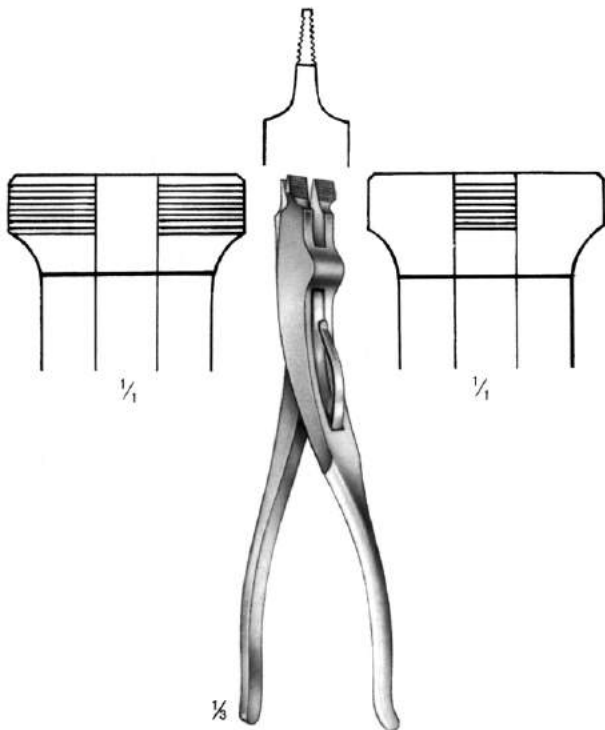
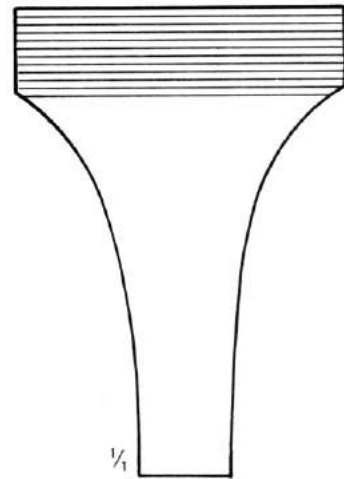

Mod. USA
 23 cm/9"
 L-0930.23

Plaster Breakers



Wolff

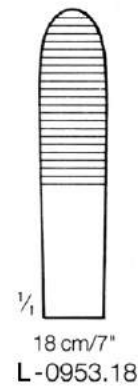

18 cm/7"
 L-0953.18



24 cm/9 1/2"
 16-0953.24

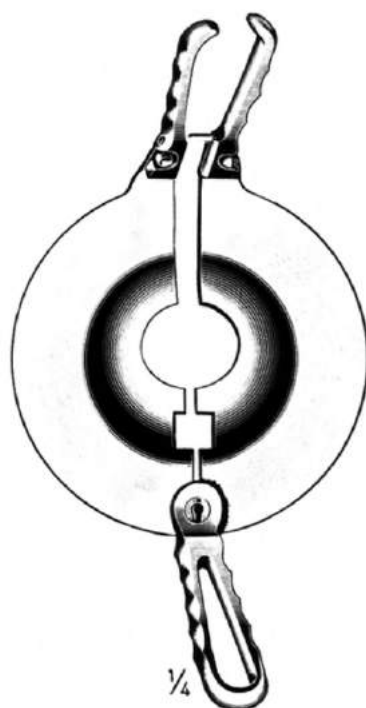

simple pattern, detachable handles

Percy
L-1100.10

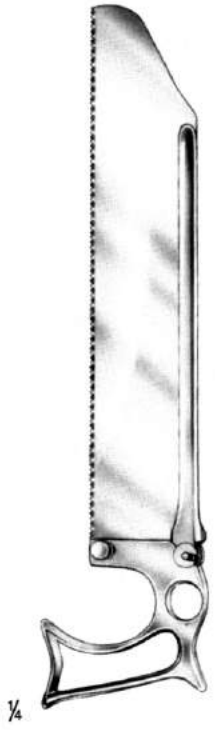

spare saw blade
L-1220.77

Weiss
37 cm / 14 1/2"
L-1220.37

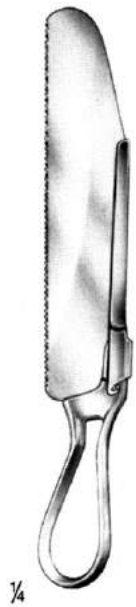

spare saw blades
18 cm / 7"
L-1230.78
20 cm / 8"
L-1230.80

Charrière

cm	inch	
27	10 3/4	L-1230.27
30	12	L-1230.30

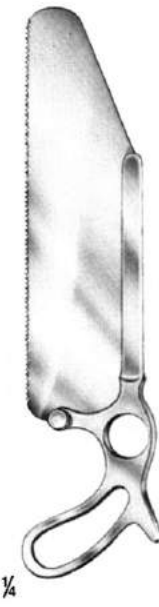

spare saw blade
19 cm / 7 1/2"
L-1235.79

Satterlee
29 cm / 11 1/2"
L-1235.29

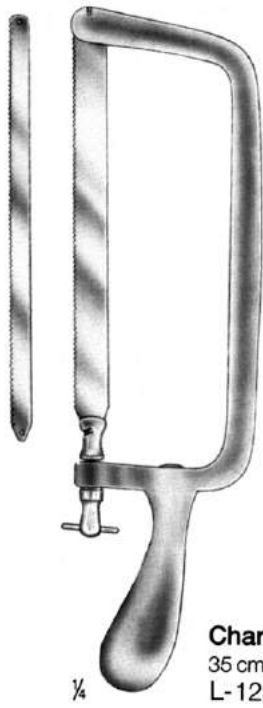

spare saw blades
12 mm
L-1251.12
15 mm
L-1251.15
18 mm
L-1251.18

Charrière
35 cm / 13 3/4"
L-1250.35

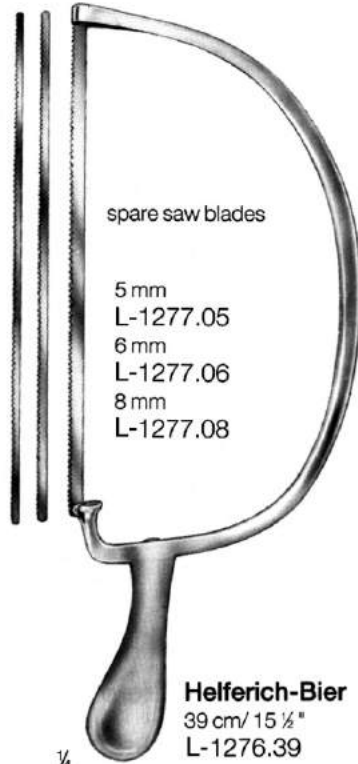

spare saw blades
5 mm
L-1277.05
6 mm
L-1277.06
8 mm
L-1277.08

Helferich-Bier
39 cm / 15 1/2"
L-1276.39

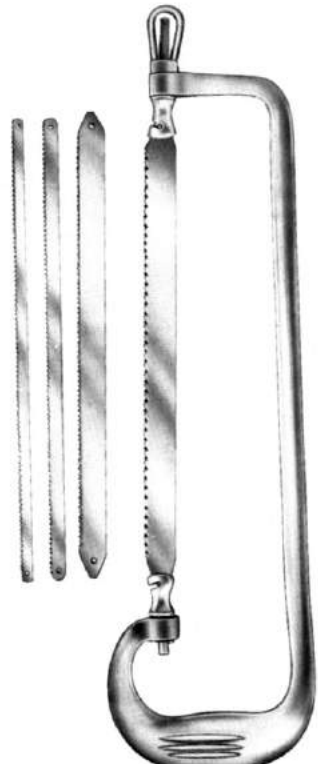

spare saw blades
6 mm
L-1281.06
8 mm
L-1281.08
15 mm
L-1281.15
18 mm
L-1281.18

Rust
39 cm / 15 1/2"
L-1280.39

with 2 saw blades, 12 m and 18 mm wide

with 1 each saw blade 5, 6 and 8 mm

with 1 each saw blade 6, 8, 15 and 18 mm

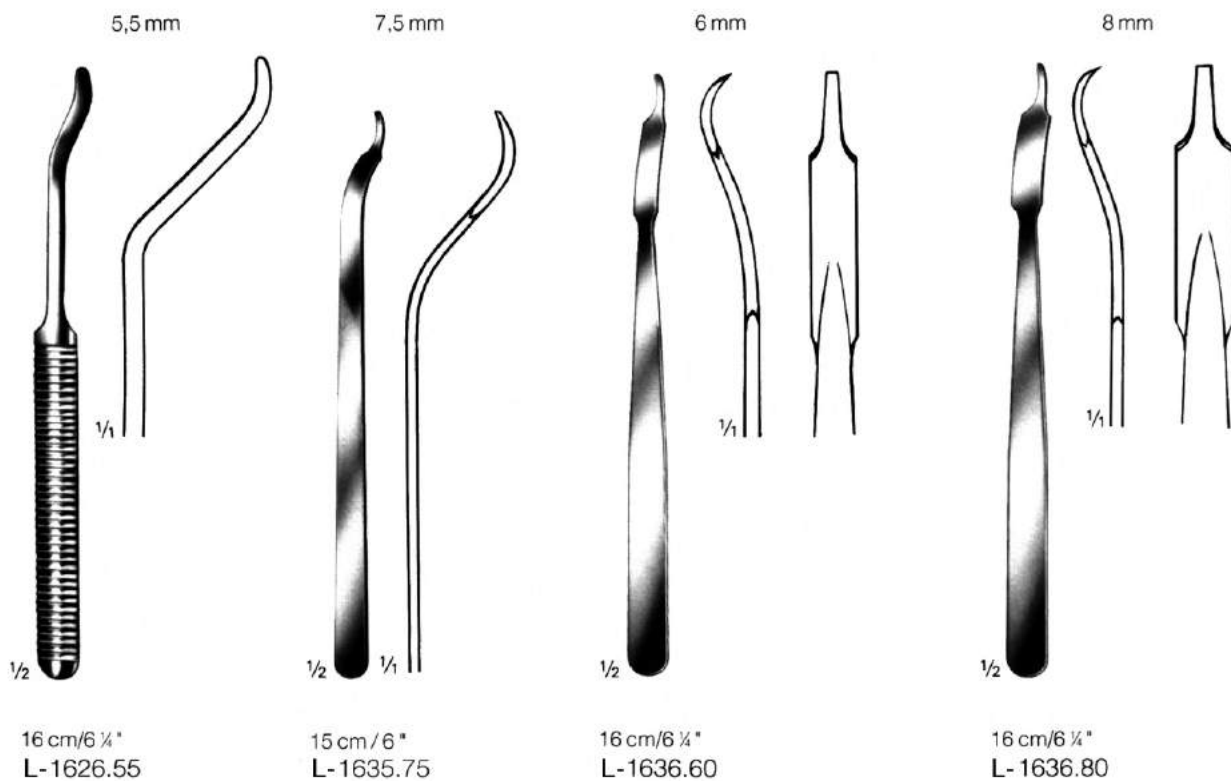
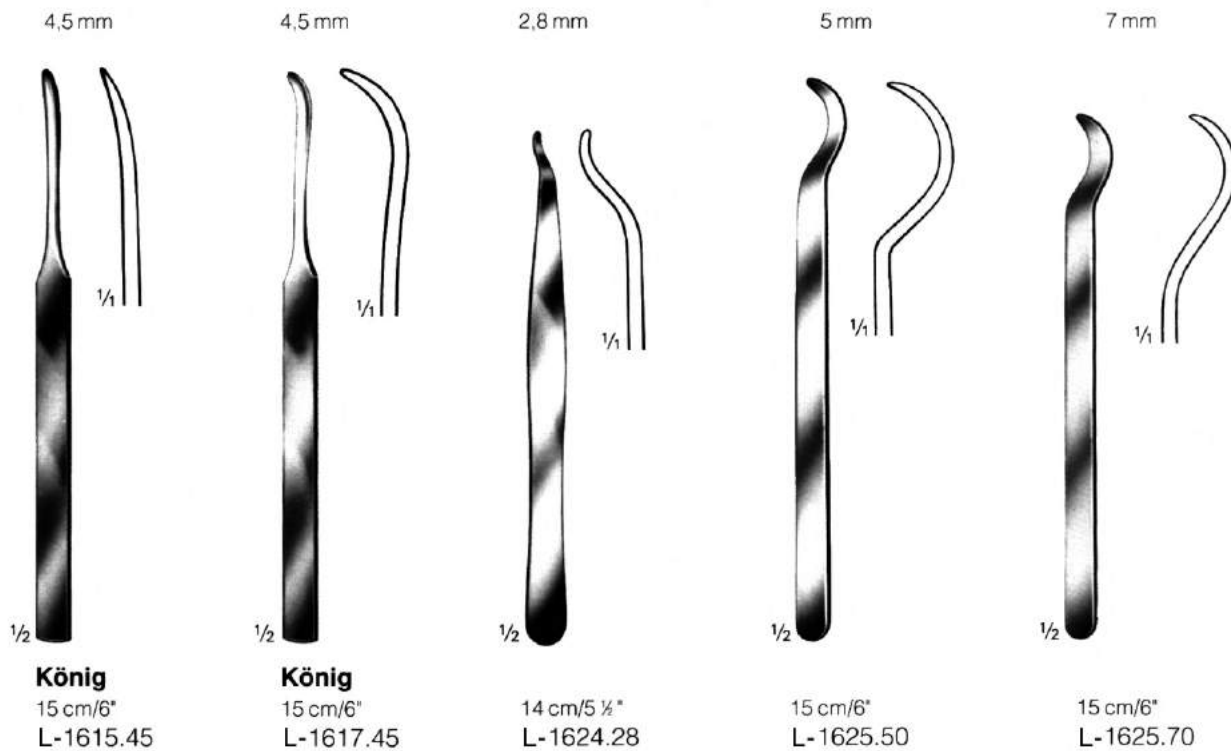

Luxation Lever (Bone Skid)

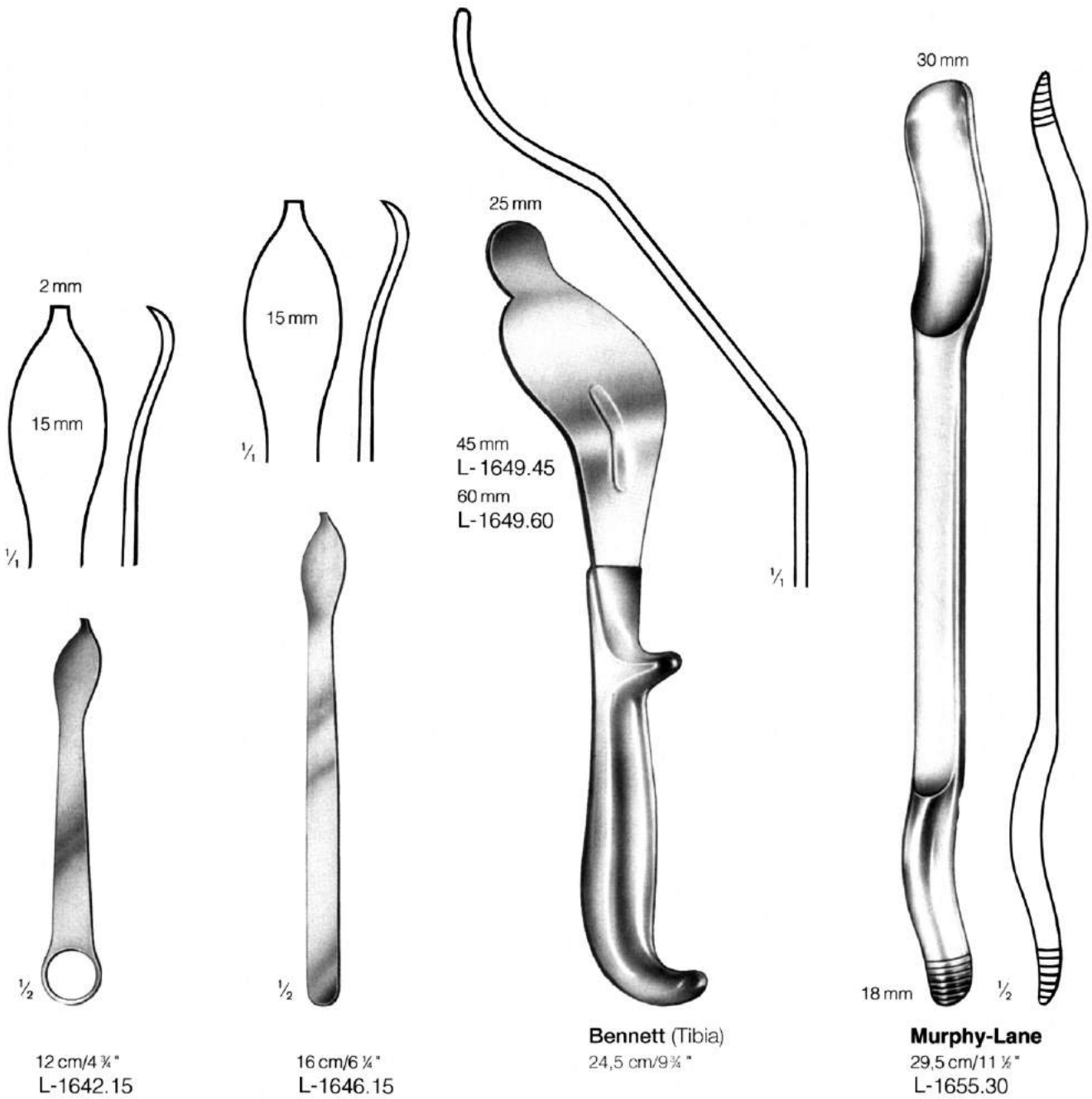

8 mm

18 mm

43 mm

70 mm



Hohmann
 22 cm/8 1/2"
 L-1660.08

Hohmann
 24 cm/9 1/2"
 L-1660.18

Hohmann
 24 cm/9 1/2"
 L-1660.43

Hohmann
 24 cm/9 1/2"
 L-1660.70

24 mm

22 mm

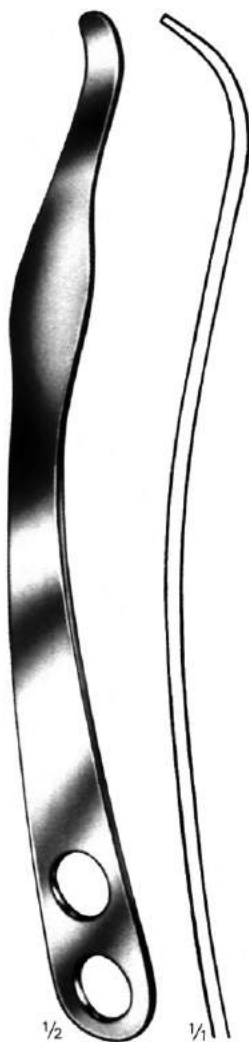

26,5 cm/10 5/8*
L-1664.24

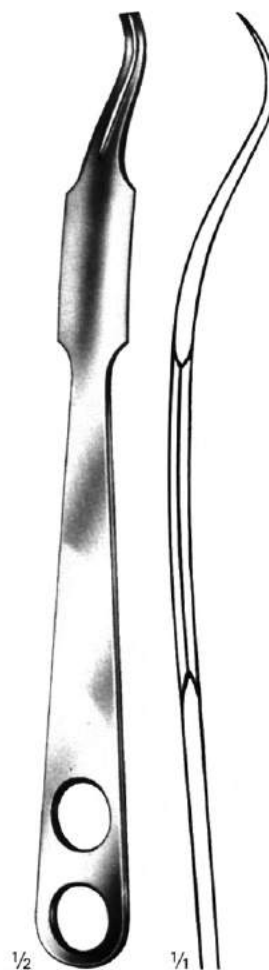

Lange-Hohmann
26 cm/10 1/4*
L-1665.22

43 mm



Hohmann
 24,5 cm/9 3/4"
 L-1661.43

22 mm

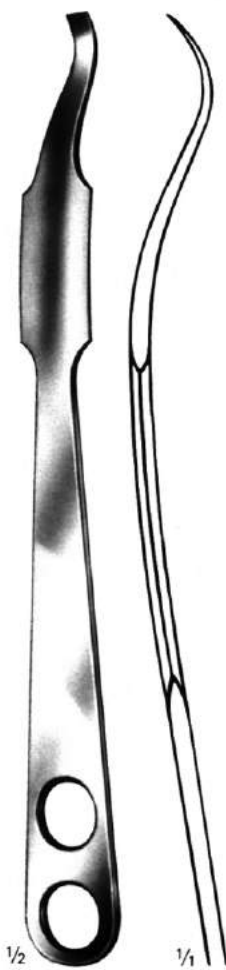

Hohmann
 26 cm/10 1/4"
 L-1662.22

33 mm

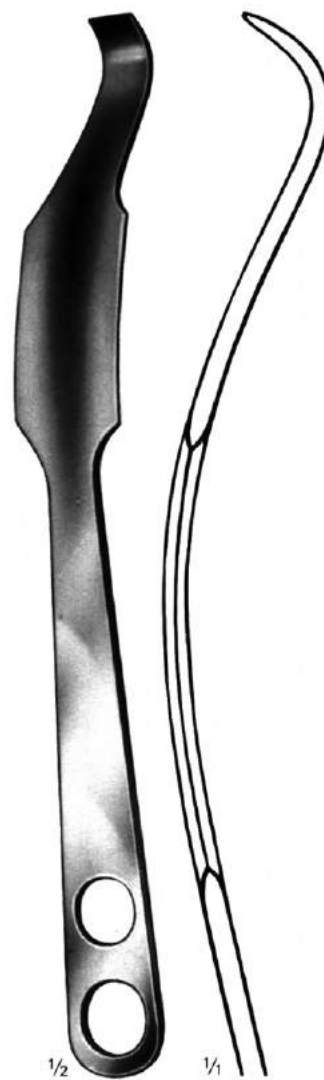

Hohmann
 28 cm/11"
 L-1662.33

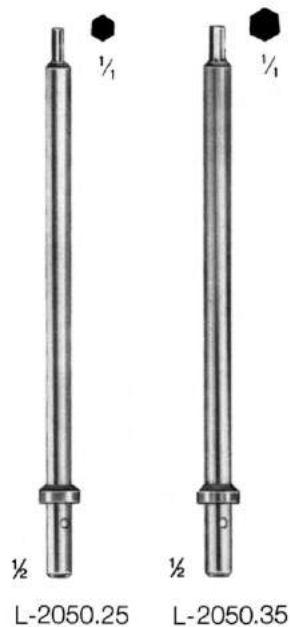
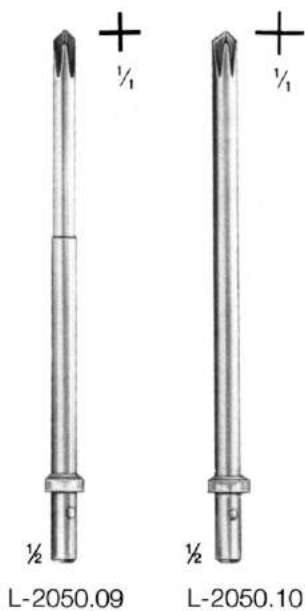
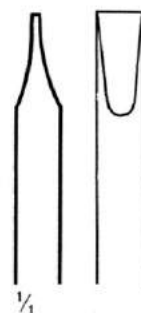
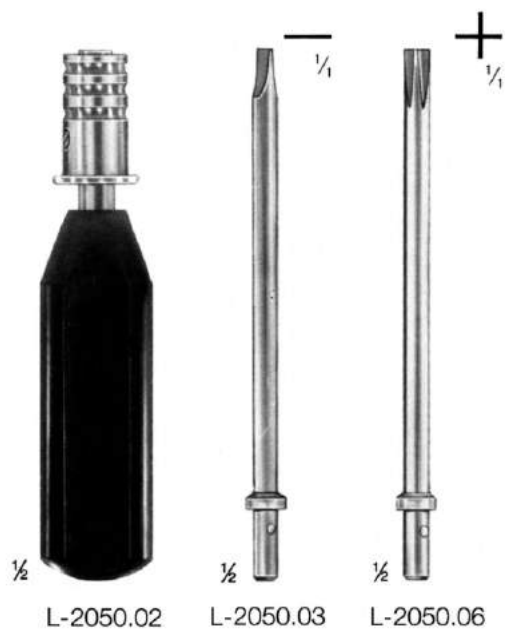

Reamers

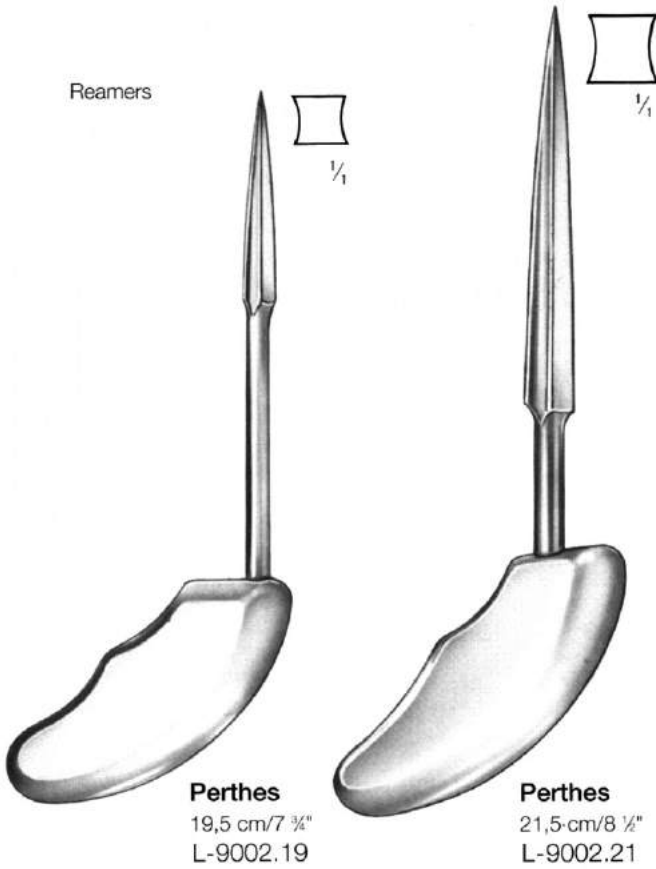

Mandibular Awl

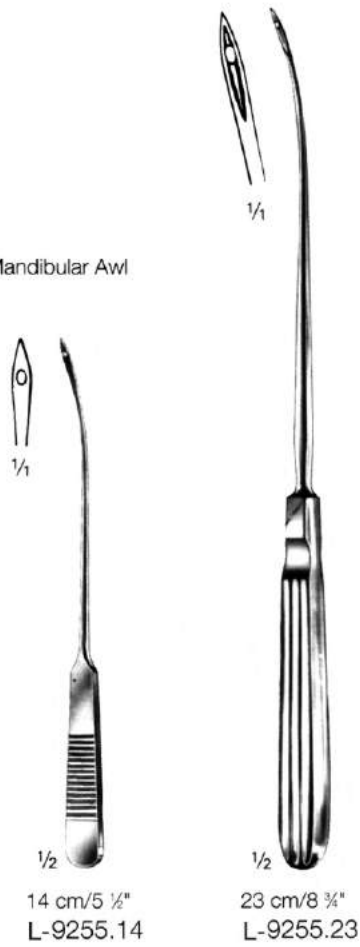

Maxillary Awl



Bone Wire

Bone Wire Guides

soft

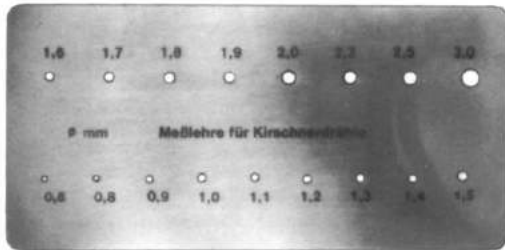

1/2

L-9206.30



1/2

Ø mm	
0.2	L-9210.02
0.3	L-9210.03
0.4	L-9210.04
0.5	L-9210.05
0.6	L-9210.06
0.7	L-9210.07
0.8	L-9210.08
0.9	L-9210.09
1.0	L-9210.10
1.2	L-9210.12
1.5	L-9210.15

SMO steel wire
in coils of 10 m



1/2

Demel
28 cm/11"

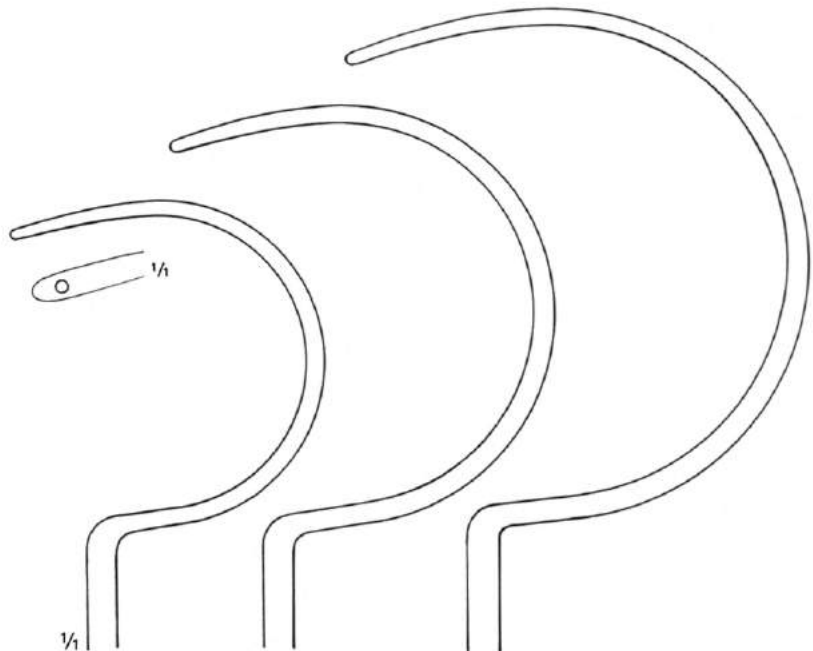
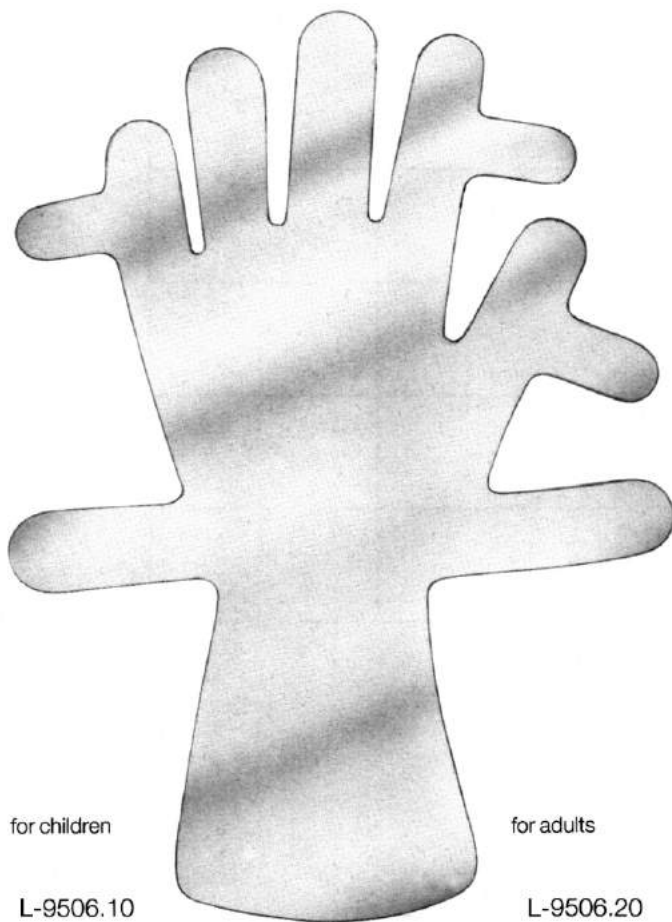

Fig. 1
L-9228.01

Fig. 2
L-9228.02

Fig. 3
L-9228.03

Lead Hands



for children

L-9506.10

for adults

L-9506.20

Metacarpal Saw



½

Langenbeck

23 cm/9"

L-9508.23

Length of blade

115 mm

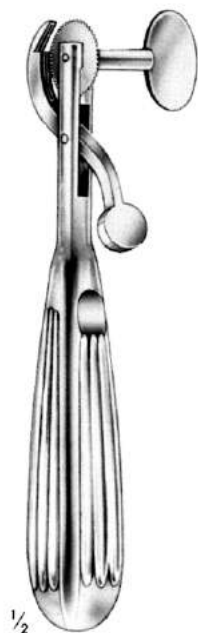

$\frac{1}{2}$
16 cm/6 $\frac{1}{4}$ "
L-7610.16



$\frac{1}{2}$
17 cm/6 $\frac{3}{4}$ "
L-7620.17



N

- Otolology, rhinology, tonsillectomy
- Otologie, rhinologie, amygdalotomie
- Otología, rinología, amigdalotomía



Brünings

N-0120.00

Pneumatic Otoscope, in wooden case, consisting of:

- 1 ea. Ear Speculum fig. 1 - 4
- 1 Rubber Tube and Bulb
- 1 Suction Head



- N-0120.55 # 0
- N-0120.65 # 1
- N-0120.75 # 2
- N-0120.85 # 3
- N-0120.95 # 4
- N-0121.05 # 5

Brünings

- | | | |
|----------|----------|----------|
| 0 | 1 | 2 |
| Ø 5,5 mm | Ø 6,5 mm | Ø 7,5 mm |

- | | | |
|----------|----------|-----------|
| 3 | 4 | 5 |
| Ø 8,5 mm | Ø 9,5 mm | Ø 10,5 mm |

- Rubber Tube and Bulb
N-0120.15
- Suction Head
N-0120.13

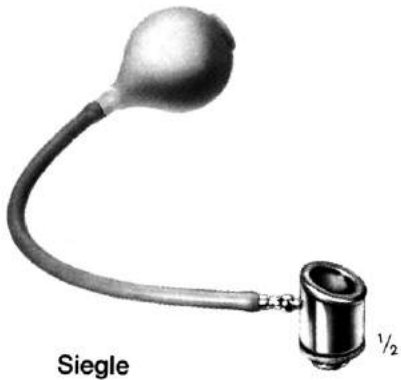

Siegle

Pneumatic Otoscope,
cpl., consisting of:

- 1 ea Ear Speculum fig. 1 - 3
- 1 Rubber Tube and Bulb
- 1 Suction Head

- N-0122.00 **without** enlargement
- N-0122.01 **with** enlargement

- | | | |
|----------|--------|--------|
| 1 | 2 | 3 |
| Ø 6,5 mm | Ø 7 mm | Ø 8 mm |



- 1 2 3

- Suction Head only
- N-0122.12 **without** enlargement

- N-0122.13 **with** enlargement

Specula only

- N-0122.65 = fig 1 = Ø 6,5 mm
- N-0122.70 = fig 2 = Ø 7,0 mm
- N-0122.80 = fig 3 = Ø 8,0 mm
- N-0122.15 Rubber Tube and Bulb only

for children



Set of 3 1-3 N-0130.03

for adults



Set of 3 3-5 N-0131.03
 4 2-5 N-0131.04

for adults



Set of 3 1-3 N-0134.03

for adults



Set of 3 2-4 N-0136.03
 4 1-4 N-0136.04

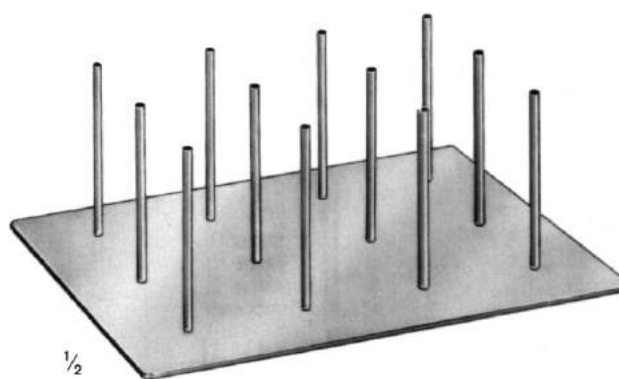

N-0159.12

Metal Support for Specula

Loops

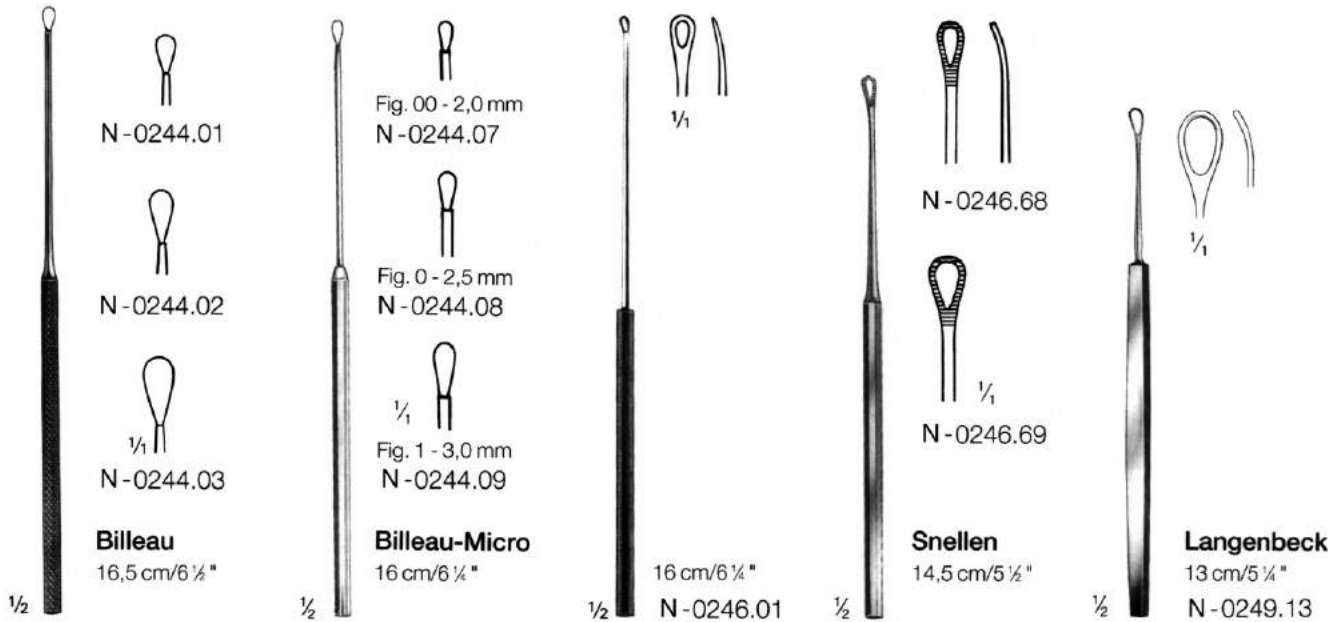

Mastoid Probe

Foreign Body Instruments

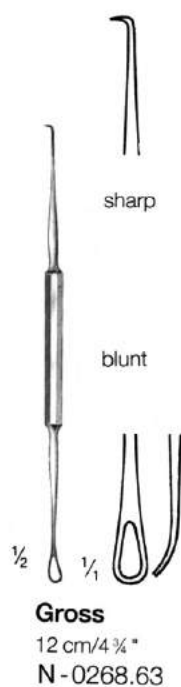

Ear Cures

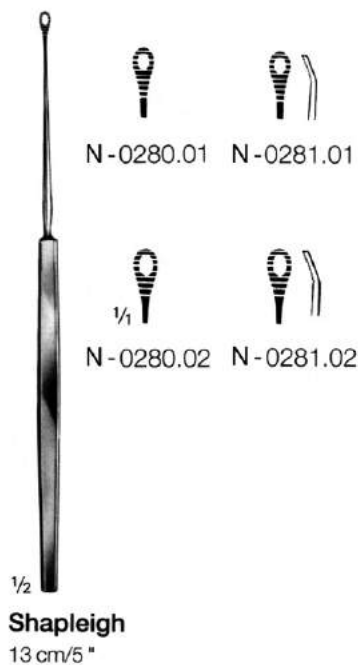

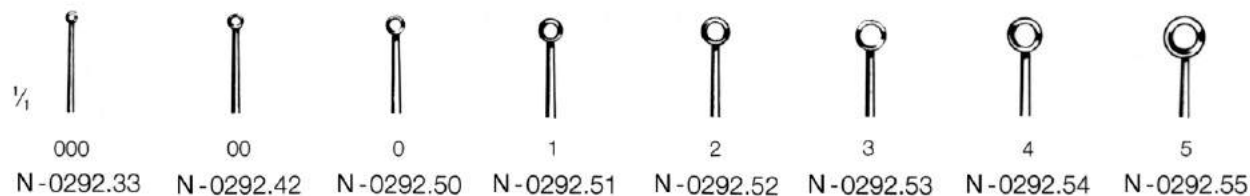
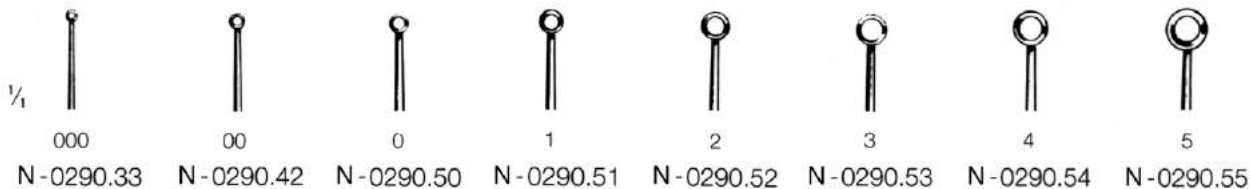

Buck
 1/2 16,5 cm/6 1/2"

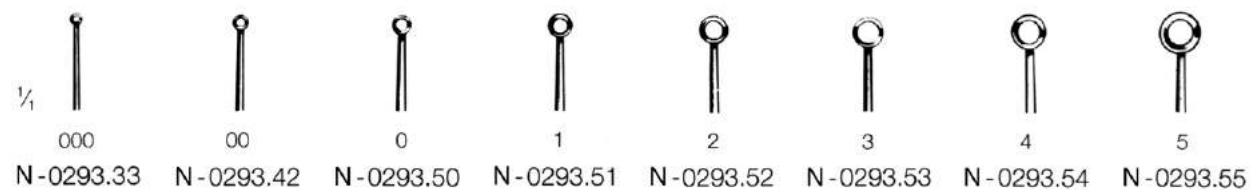
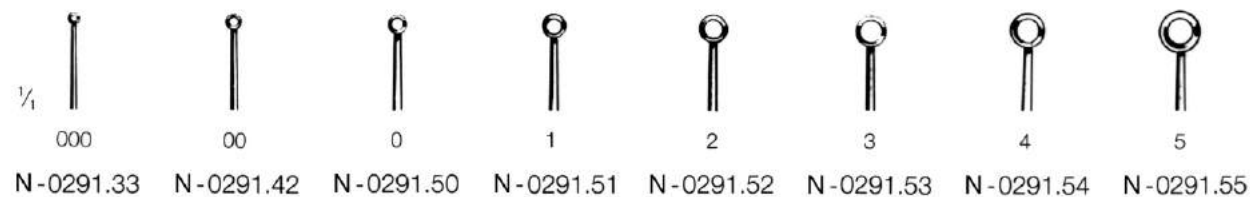

Buck
 1/2 16,5 cm/6 1/2"

Politzer air bag, ear syringes
Insufflateur d'aire de politzer, seringues auriculaires
Insufladores de aire según politzer, jeringas para oído



1/2

Politzer

Rubber Bulb only

N-0430.50

complete

N-0430.01



1/2

N-0430.03

Connecting Nozzle



4 mm Ø
N-0430.04



15 mm Ø
N-0430.15



17 mm Ø
N-0430.17



22 mm Ø
N-0430.22

Nasal tips



1/2

Ear Syringe, all metal, with Luer-Lock mount, complete with 2 tips and 1 shield, in cardboard box



N-4425.55



N-4425.60



N-4425.70

1/2

complete

Syringe only

50 ml	N-4420.50	N-4430.50
75 ml	N-4420.75	N-4430.75
100 ml	N-4421.00	N-4431.00



11 cm/4 3/8"
 N-0440.11

1/2

Spare Glass Bottle, 30 ml
 N-0440.30
 Rubber Bulb only
 N-0440.50

Ear Cannula only, 8 cm/3 1/8"
 N-0440.08
 Nasal Cannula only, 11 cm/4 3/8"
 N-0440.11
 Laryngeal Cannula only, 13 cm/5"
 N-0440.13

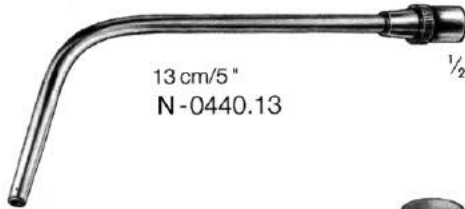

13 cm/5"
 N-0440.13

1/2



8 cm/3 1/8"
 N-0440.08

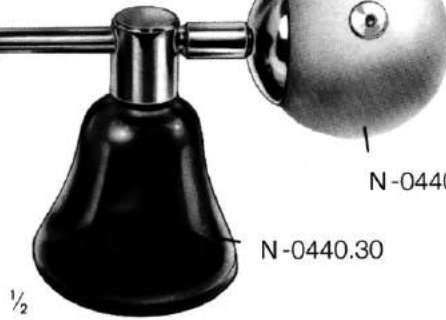

N-0440.30

N-0440.50

1/2

Kabierske

30 ml
 N-0440.00

Powder Blower, 30 ml, complete with 1 ea cannula for ear, nose, larynx

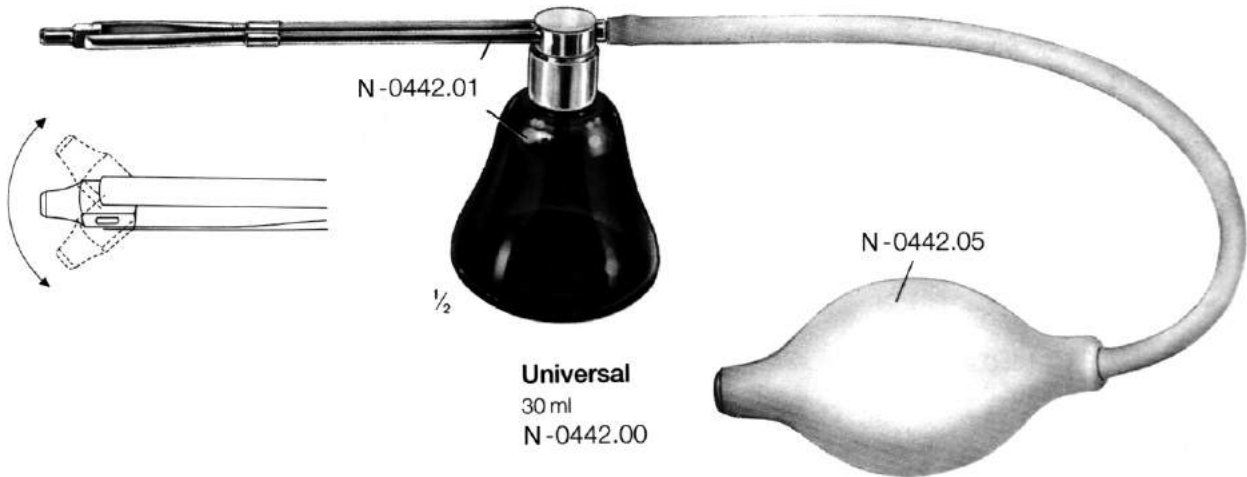

N-0442.01

1/2

N-0442.05

Universal

30 ml
 N-0442.00

Powder Blower, 30 ml, with mobile nozzle and rubber bulb
 same, without rubber bulb N-0442.01
 Rubber bulb only N-0442.05



Krause
18 cm/7 "
N-0735.10

Cannula only
N-0735.11
Wire Guide only
N-0735.12



Krause-Voss
18 cm/7 "
N-0735.20

Cannula with Wire Guide, only



Lange-Wilde
18 cm/7 "
N-0735.30

Wire Guide only

Foreign Body Levers

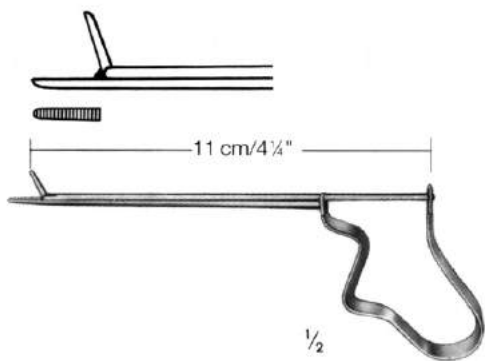

Buck
 11 cm/4 1/4"
 N-0800.11

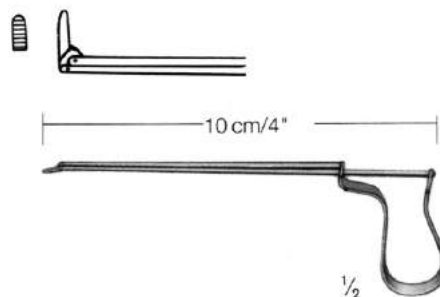

Quire
 10 cm/4"
 N-0802.10

Ear Polypus Forceps, Tampon Forceps

delicate pattern

Standard

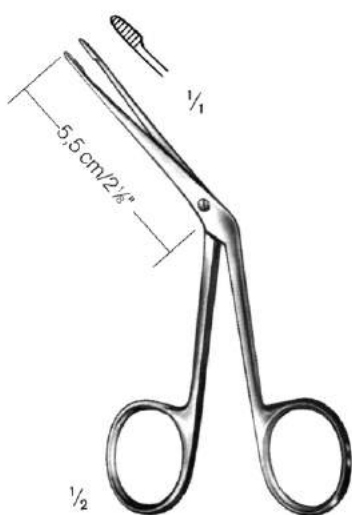

Hartmann
 13,5 cm/5 1/4"
 N-0810.13

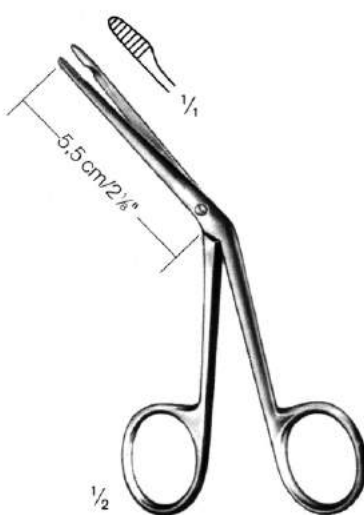

Hartmann
 13,5 cm/5 1/4"
 N-0812.13

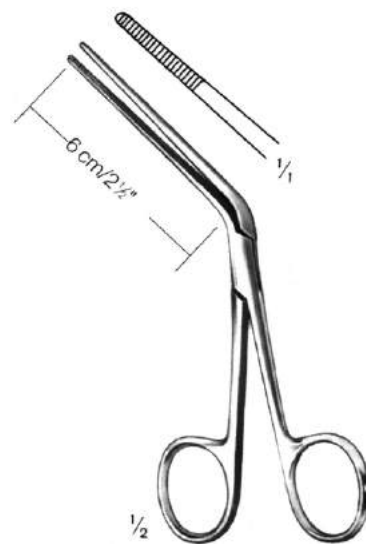

Tilley (Yankauer)
 14 cm/5 1/2"
 N-0821.14

Ear polypus forceps, tampon forceps
Pinces pour polypes auriculaires, pinces porte-tampons
Pinzas para pólipos auriculares y para taponamientos



Hartmann-Wullstein
N-1024.08

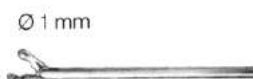

Hartmann-Wullstein
N-1020.08

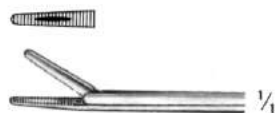

Hartmann
N-1030.08 = 8,5 cm
N-1030.14 = 14,0 cm
N-1030.16 = 16,0 cm

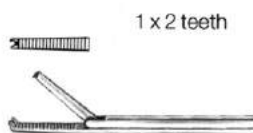

Hartmann
N-1032.08 = 8,5 cm
N-1032.14 = 14,0 cm

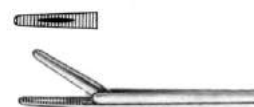

Hartmann-Noyes
N-1040.09 = 9 cm



N-1041.08



Weingärtner
N-1043.08



Strümpel
N-1050.08



Hartmann
N-1052.08



Hartmann
N-1058.20 = 2,0 mm
N-1058.25 = 2,5 mm
N-1058.30 = 3,0 mm



Hartmann
N-1059.20 = 2,0 mm
N-1059.25 = 2,5 mm
N-1059.30 = 3,0 mm



Hartmann
N-1074.08



Hartmann-Hoffmann
N-1078.20

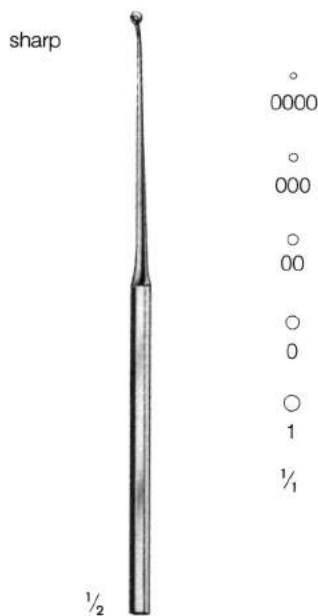

Buck-Wullstein-Micro
16 cm/6 $\frac{1}{4}$ "

N-2110.24	Fig. 0000	0,9 mm Ø	N-2111.24
N-2110.33	Fig. 000	1,1 mm Ø	N-2111.33
N-2110.42	Fig. 00	1,3 mm Ø	N-2111.42
N-2110.50	Fig. 0	1,8 mm Ø	N-2111.50
N-2110.51	Fig. 1	2,1 mm Ø	N-2111.51

Ø = inside diameter

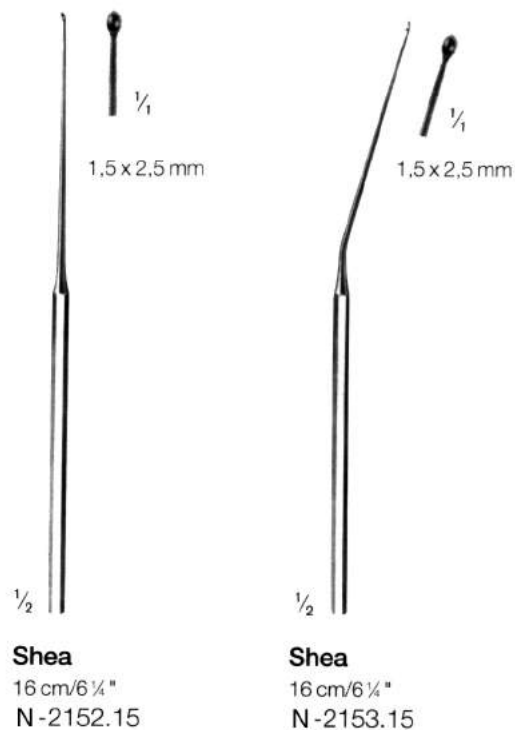

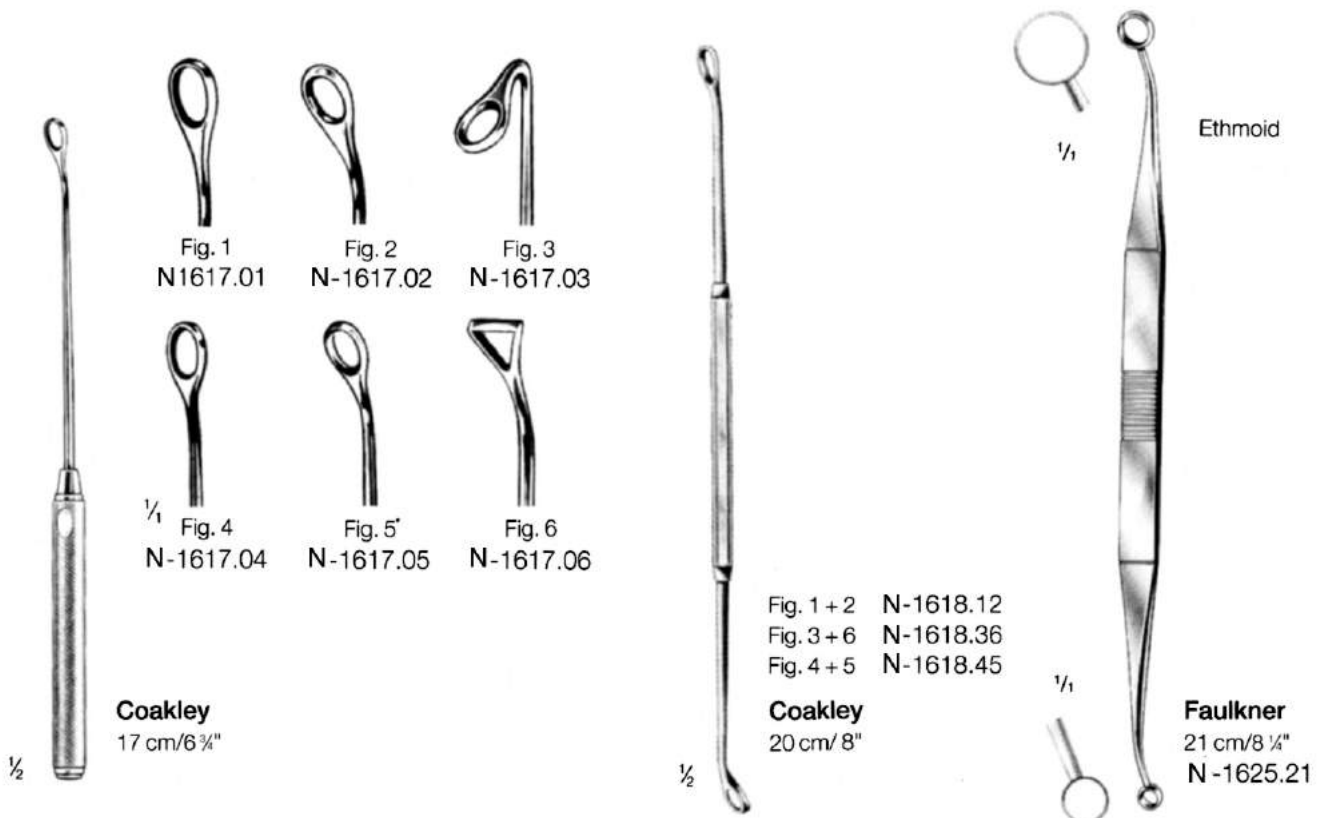



House
15 cm/6 "

N-2210.12 = 1,0/1,2 mm
 N-2215.18 = 1,5/1,8 mm

slightly angled



House
15 cm/6 "

N-2211.12 = 1,0/1,2 mm
 N-2216.18 = 1,5/1,8 mm

strongly angled

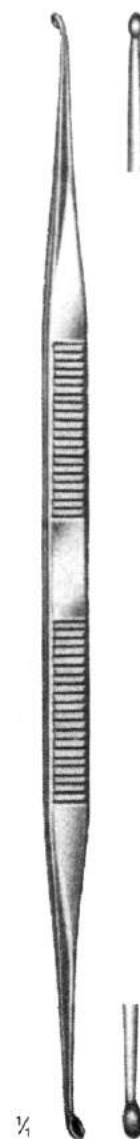

House
17 cm/6 3/4 "

N-2217.01 = 1,5/1,8 mm = N-2217.02

slightly angled

strongly angled



Barbara
N-2300.01

Needle, straight, sharp point



N-2300.03

Needle, light curve, sharp point



Rosen
N-2300.06

Needle, strong curve, sharp point



Shambaugh
N-2325.04 = 0,4 mm
N-2325.06 = 0,6 mm
N-2325.08 = 0,8 mm
N-2325.10 = 1,0 mm

Hooklets, angled



Shambaugh
N-2345.04 = 0,4 mm
N-2345.06 = 0,6 mm
N-2345.08 = 0,8 mm
N-2345.10 = 1,0 mm
N-2345.12 = 1,2 mm
N-2345.15 = 1,5 mm
N-2345.20 = 2,0 mm
N-2345.25 = 2,5 mm

Hooklets, angled



Shambaugh
N-2390.04 = 0,4 mm
N-2390.06 = 0,6 mm
N-2390.08 = 0,8 mm
N-2390.10 = 1,0 mm
N-2390.12 = 1,2 mm
N-2390.15 = 1,5 mm
N-2390.20 = 2,0 mm
N-2390.25 = 2,5 mm

Hooklets, angled



N-2426.06 = 0,6 mm

Hooklets, retrograde



N-2429.10 = 1,0 mm
N-2429.25 = 2,5 mm

Hooklets, retrograde



Plester
N-2445.16

Antrum Hooklet, blunt



16 cm/6 1/2"

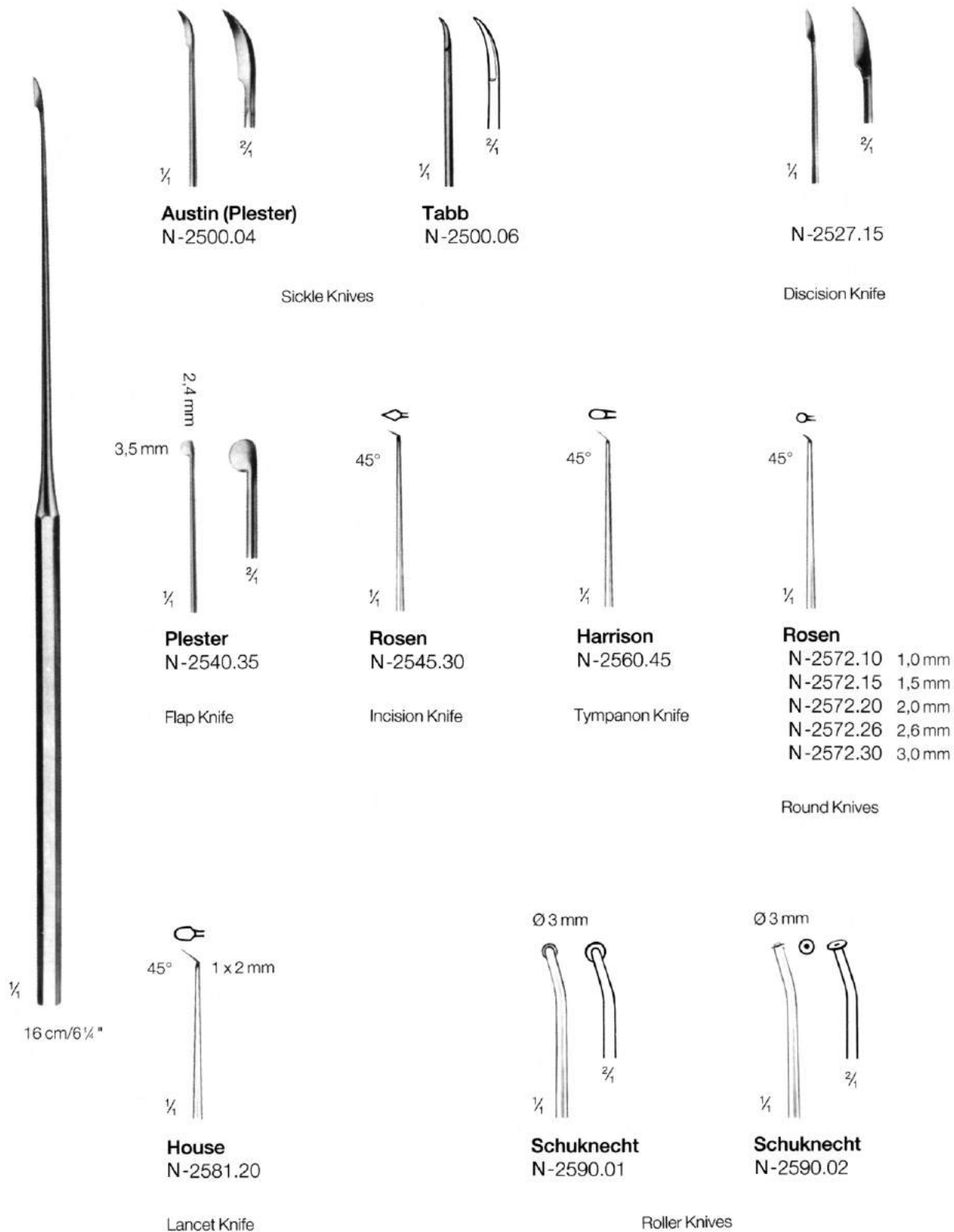

Respatories

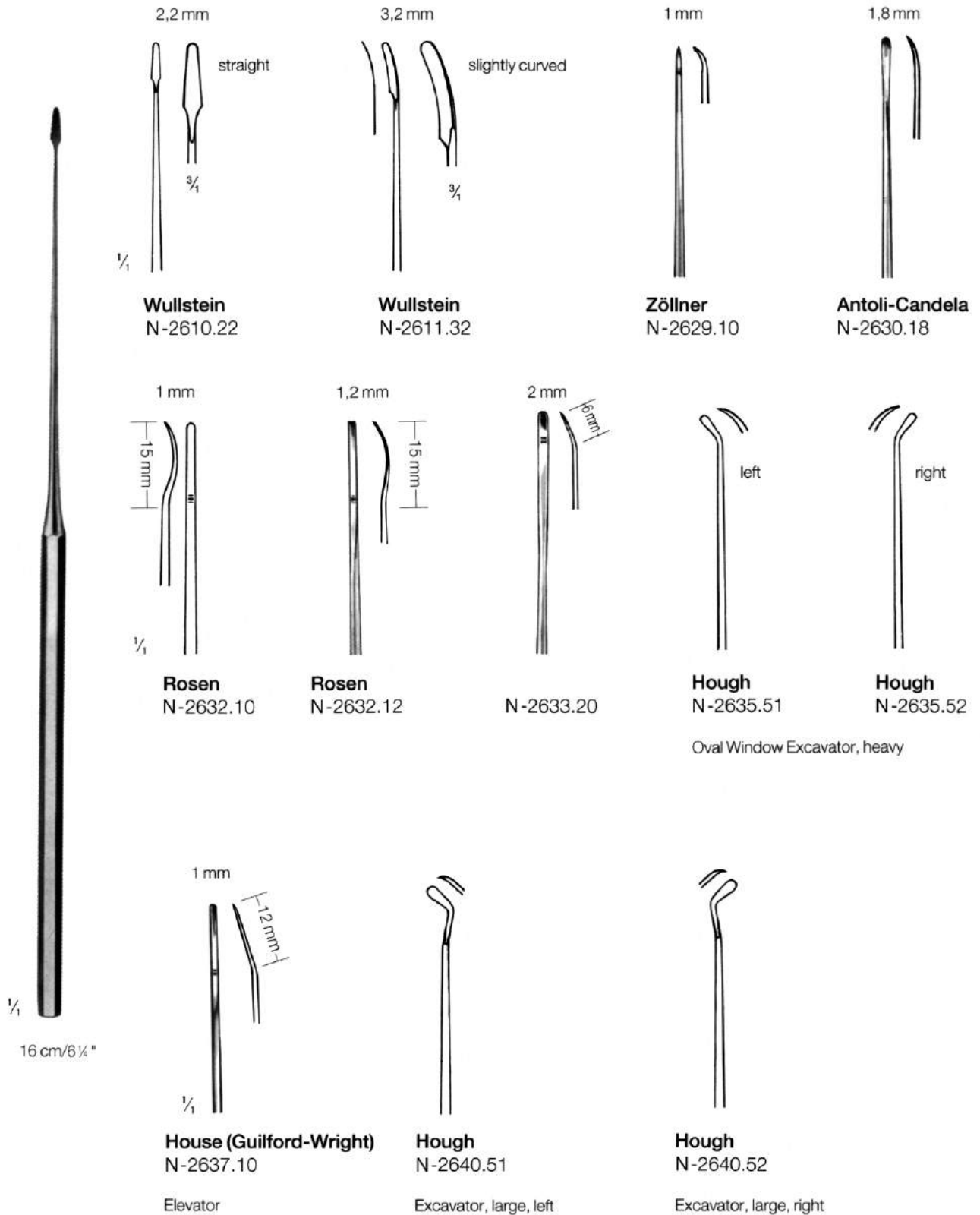

Malleus Nippers

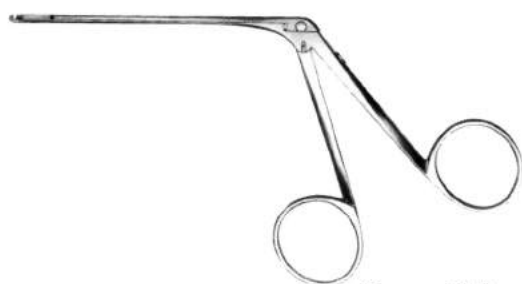
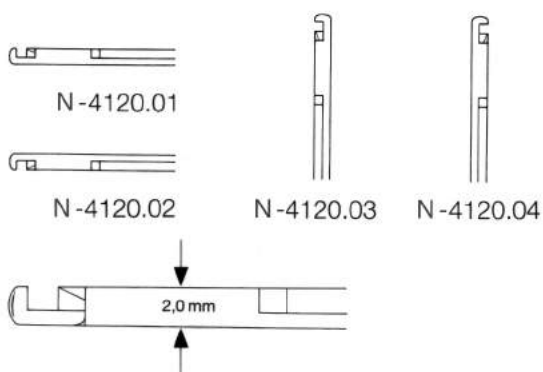

House-Dieter

Crura Nippers

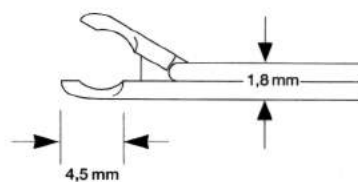
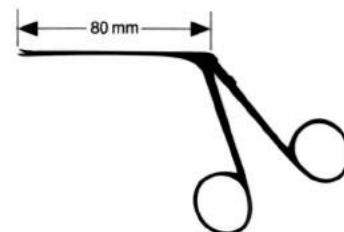

Tabb
N-4130.45

Crura Nippers

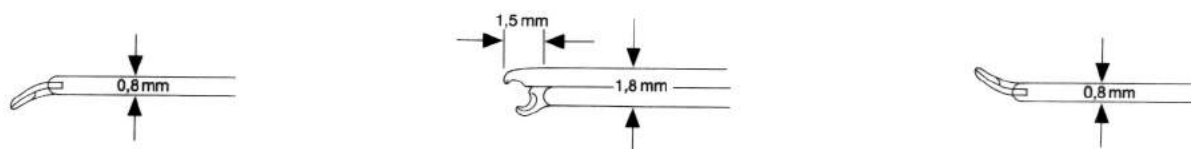

left cutting

Fisch
N-4133.01



right cutting

Fisch
N-4132.01

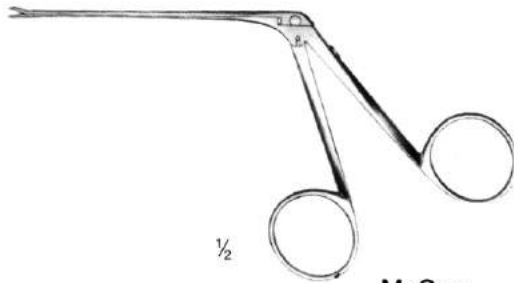
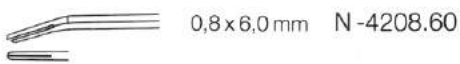
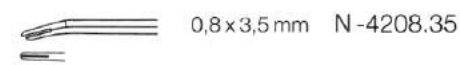
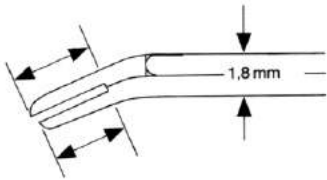

McGee

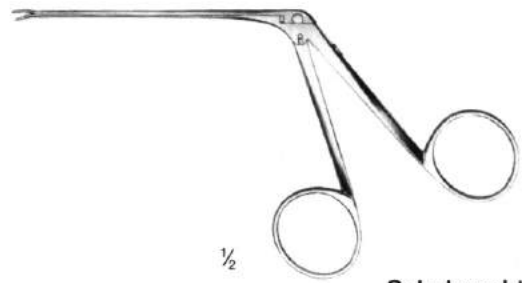
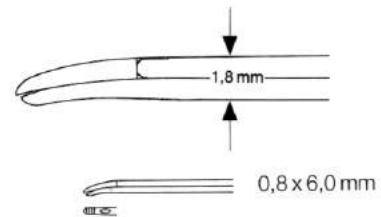
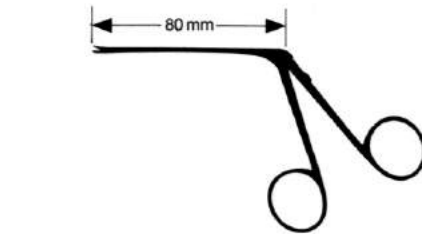

Schuknecht
N-4218.60

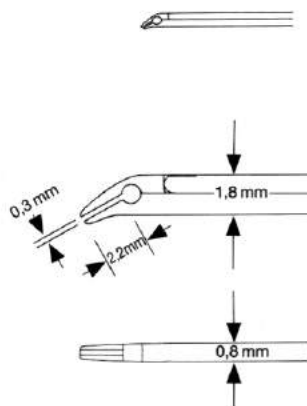

Fisch
N-4210.01

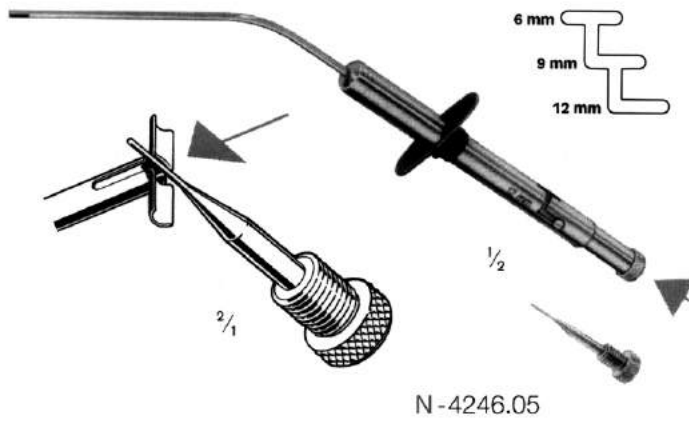

N-4246.05
 T-Tube Inserter
 adjustable in 6, 9 and 12 mm

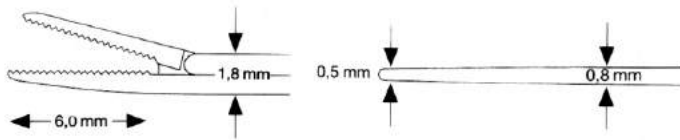

N-4242.06

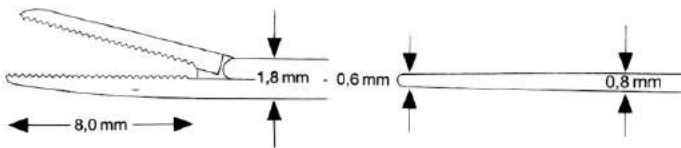
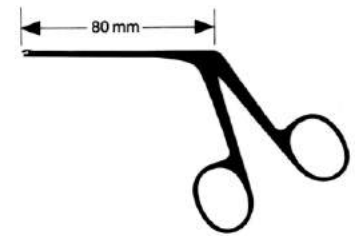

N-4242.08

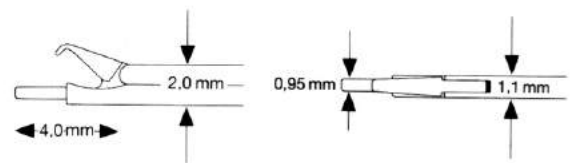

for Ventilation Tubes

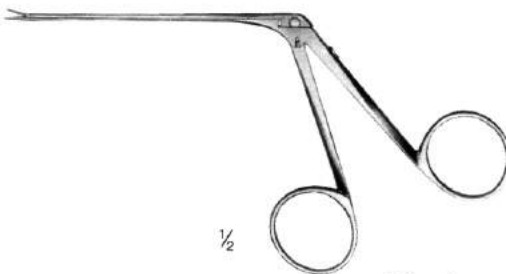



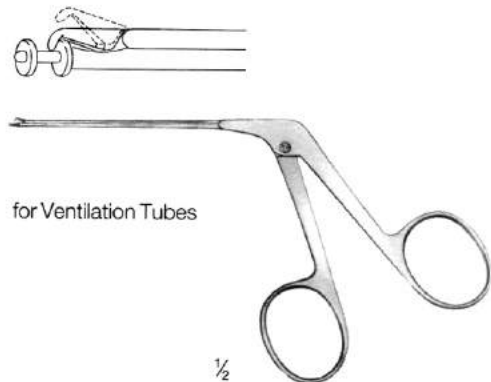



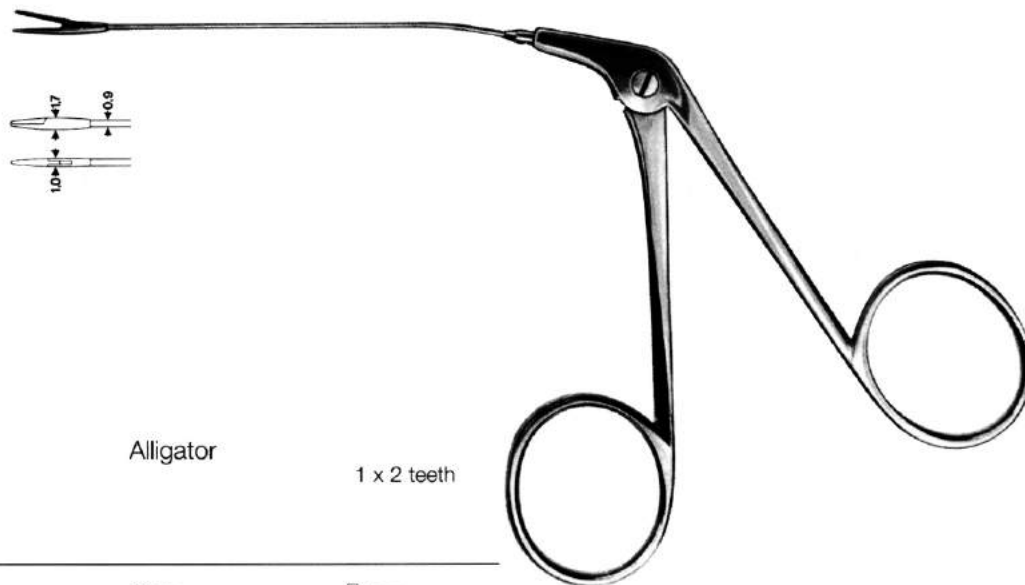



Alligator
 delicate
 N-4242.##











N-4244.05









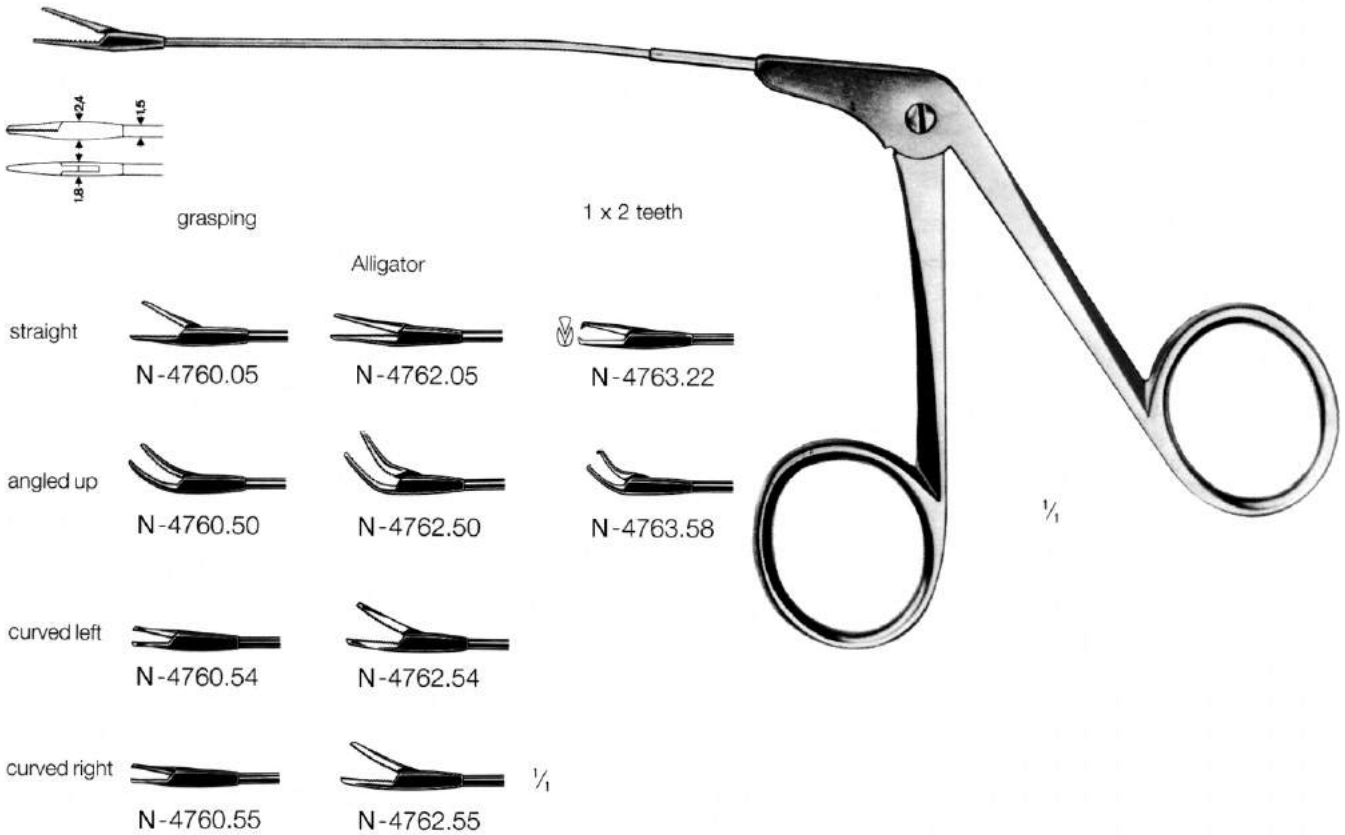













	grasping	Alligator	1 x 2 teeth
straight	 N-4720.05	 N-4722.05	 N-4723.22
angled up	 N-4720.50	 N-4722.50	 N-4723.58
curved left	 N-4720.54	 N-4722.54	
curved right	 N-4720.55	 N-4722.55	

Delicate Cup-shaped Forceps

straight	 N-4724.02	 N-4726.02
angled up	 N-4724.50	 N-4726.50
curved left	 N-4724.54	 N-4726.54
curved right	 N-4724.55	 N-4726.55



Delicate Cup-shaped Forceps

	Ø 1 mm	Ø 1,5 mm	Ø 2 mm	Ø 2,5 mm	oval
straight	 N-4910.02	 N-4915.02	 N-4920.02	 N-4925.02	 N-4933.02
angled up	 N-4910.50	 N-4915.50	 N-4920.50	 N-4925.50	 N-4933.50
curved left	 N-4910.54	 N-4915.54	 N-4920.54	 N-4925.54	 N-4933.54
curved right	 N-4910.55	 N-4915.55	 N-4920.55	 N-4925.55	 N-4933.55

Micro ear scissors with tubular shafts
Microciseaux auriculaires à tige tubulaire
Micro-tijeras auriculares con vástago tubular

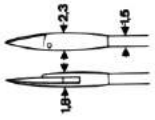

straight  N-5020.03

angled up  N-5020.33

curved left  N-5020.53

curved right  N-5020.63

straight  horizontal N-5020.73

angled up  N-5020.77

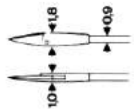

straight  N-5022.03

angled up  N-5022.33

curved left  N-5022.53

curved right  N-5022.63

straight  horizontal N-5022.73

angled up  N-5022.77

1/4

Micro ear scissors, bellucci-type, alligator action
Microciseaux auriculaires de bellucci, tige coulissante
Microtijeras auriculares según bellucci, vástago corredizo

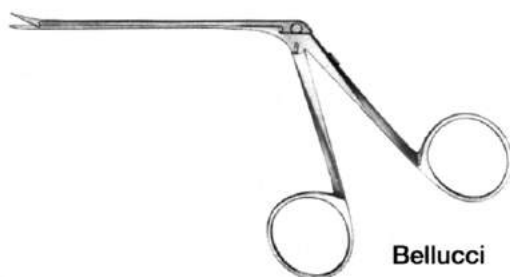

Bellucci

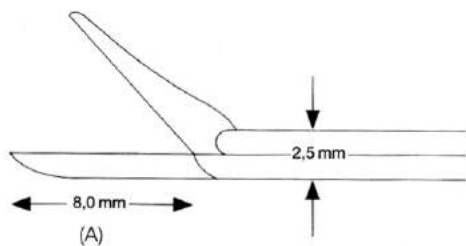
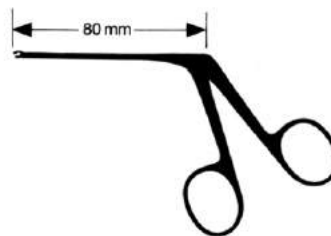

(A)

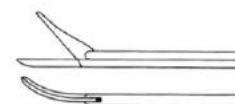
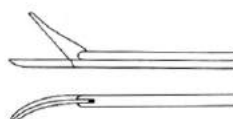
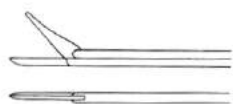
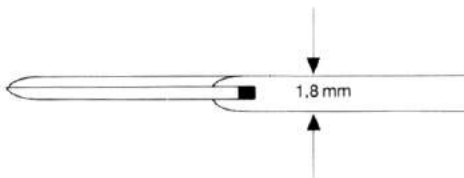

straight
sharp/blunt sharp/sharp

curved up
sharp/sharp

curved to left
sharp/sharp

curved to right
sharp/sharp

delicate

N-4618.02

N-4618.03

N-4618.33 (A = 6,0 mm)

N-4618.53

N-4618.63

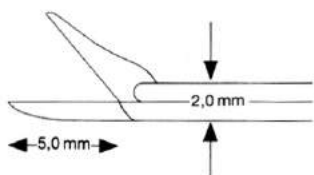

very delicate

N-4625.02

N-4625.03

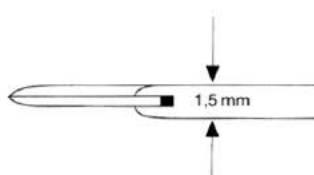

N-4625.33 (A = 4,5 mm)

N-4625.53

N-4625.63

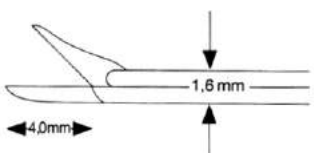

extra delicate

N-4634.02

N-4634.03

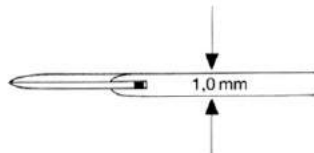

N-4634.53

N-4634.63



1/2

Palmer
N-0116.07



1/2

Thudichum (Goldsmith)

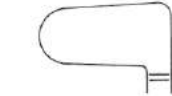

N-0132.01



N-0132.02



N-0132.03

1/4



1/2

Voltolini



N-0140.01

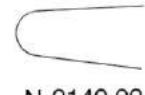

N-0140.02



N-0140.03

1/4



1/2

Modell Wien (Vienna pattern)
14 cm/5 1/2"

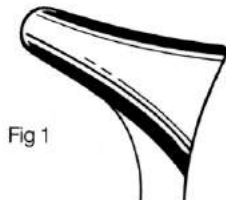

Fig 1

N-0204.01

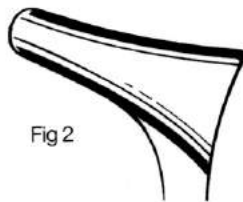

Fig 2

N-0204.02

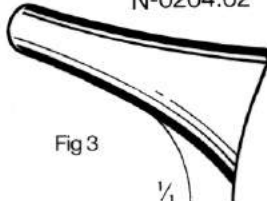

Fig 3

N-0204.03

1/4

lightweight



1/2

Hartmann/Wiener
15 cm/6"
N-0206.15

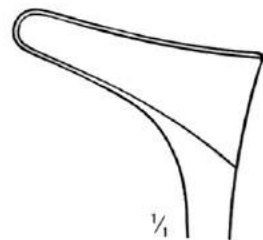

1/4

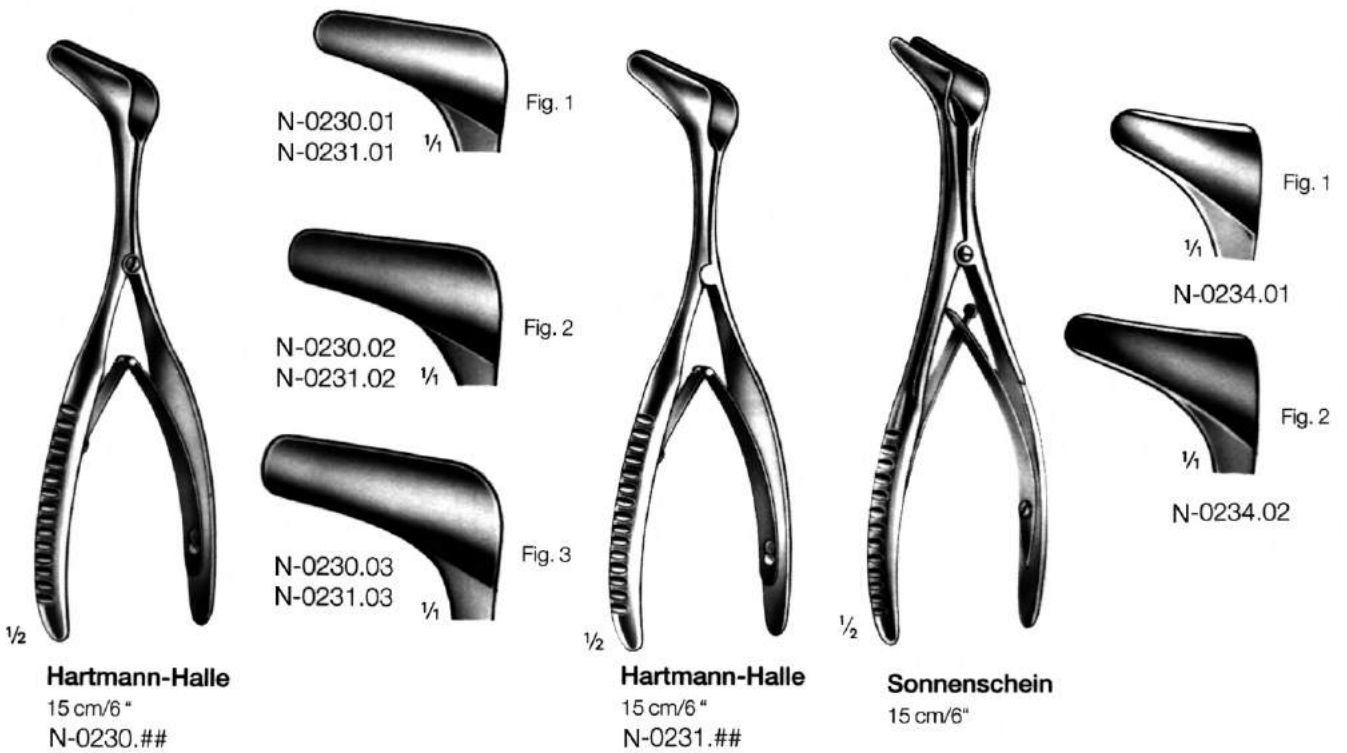
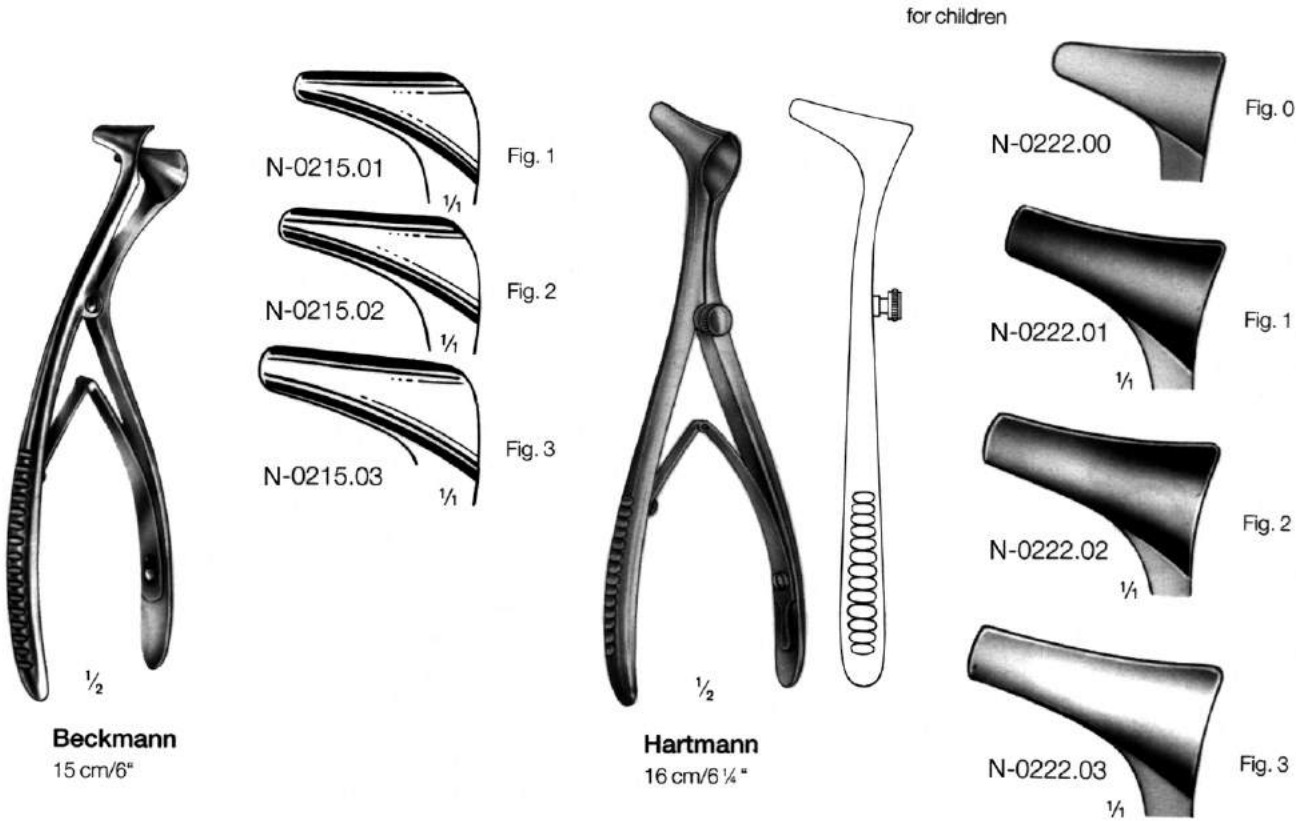



1/2

Tieck-Halle
13,5 cm/5 1/4"

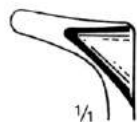

1/1

Fig. 1 N-0236.01



1/1

Fig. 2 N-0236.02

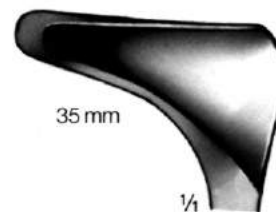

35 mm

1/1

Fig. 1

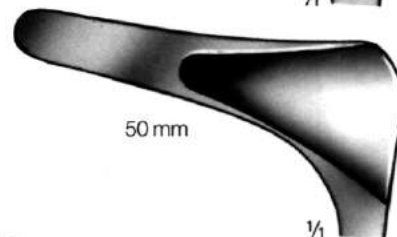

50 mm

1/1

Fig. 2

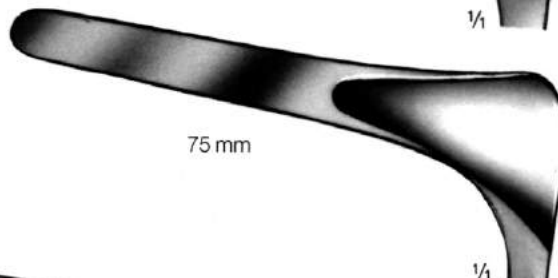

75 mm

1/1

Fig. 3

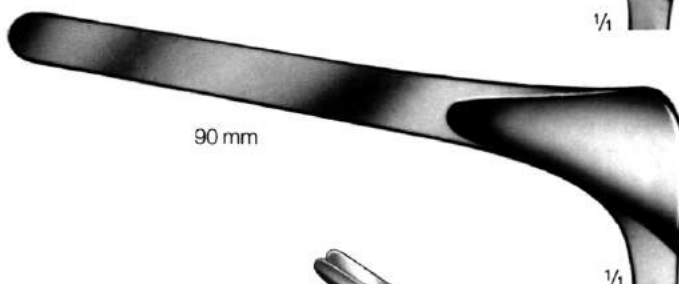

90 mm

1/1

Fig. 4



1/2

Killian

13 cm/5"

Fig. 1 N-0250.35

Fig. 2 N-0250.50

Fig. 3 N-0250.75

Fig. 4 N-0250.90



1/2

Killian

13 cm/5"

Fig. 1 N-0251.35

Fig. 2 N-0251.50

Fig. 3 N-0251.75

Fig. 4 N-0251.90



1/2

Cottle

15 cm/6"

Fig. 1 N-0260.35

Fig. 2 N-0260.50

Fig. 3 N-0260.75

Fig. 4 N-0260.90

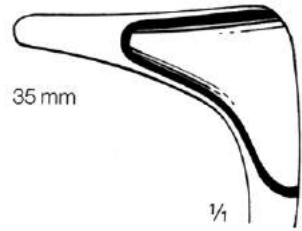

35 mm

1/4

Fig. 1

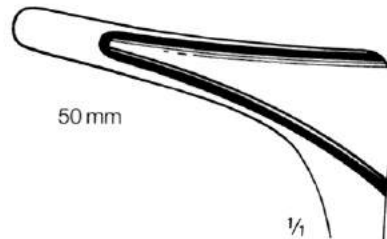

50 mm

1/4

Fig. 2

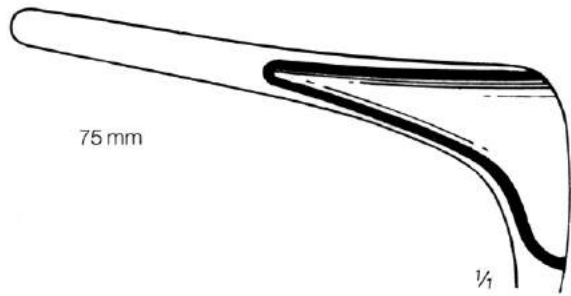

75 mm

1/4

Fig. 3

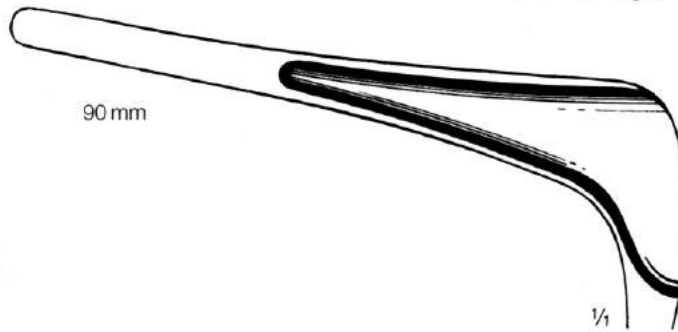

90 mm

1/4

Fig. 4

Nasal Septum Speculum



1/2

Cottle

15 cm/6"

Fig. 1 N-0261.35

Fig. 2 N-0261.50

Fig. 3 N-0261.75

Fig. 4 N-0261.90

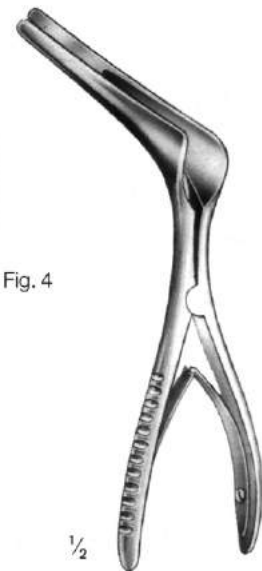

1/2

Cottle

15 cm/6"

Fig. 1 N-0264.35

Fig. 2 N-0264.50

Fig. 3 N-0264.75

Fig. 4 N-0264.90

Killian fibre optic nasal speculum

135 mm (5 1/4")
fibre light fitting (3mm)

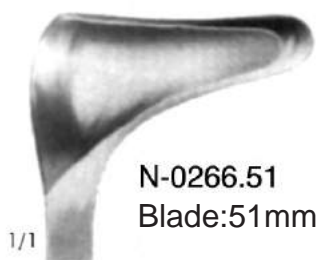

N-0266.51
Blade:51mm



N-0266.76
Blade:76mm

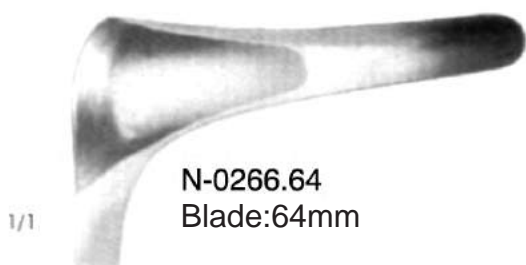



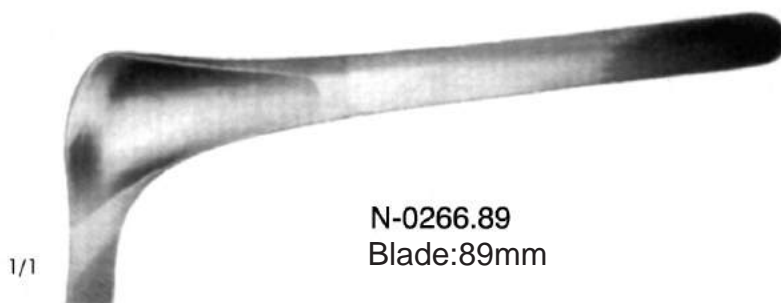



N-0266.64
Blade:64mm

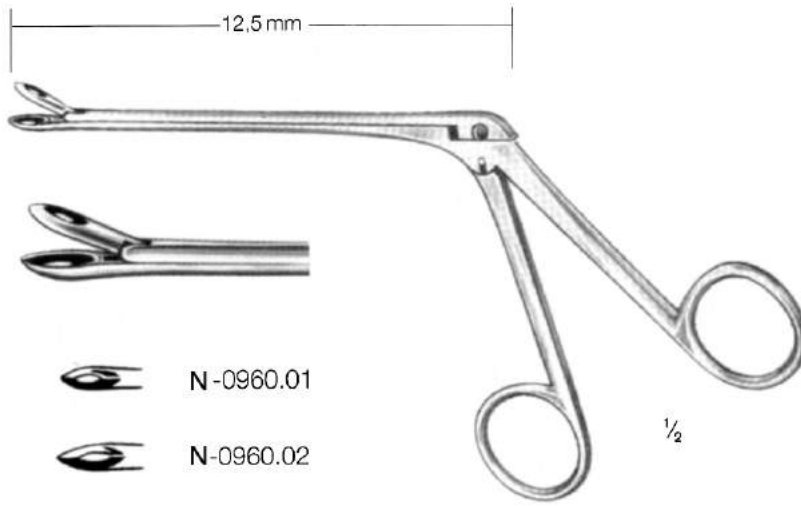

N-0266.89
Blade:89mm





Nasal cutting forceps
Pinces coupantes pour le nez
Pinzas cortantes para la nariz



-  N-0960.01
-  N-0960.02
-  N-0960.03
-  N-0960.04
-  N-0960.05

$\frac{1}{4}$ **Weil-Blakesley**



-  N-0961.01
-  N-0961.02
-  N-0961.03
-  N-0961.04
-  N-0961.05

$\frac{1}{4}$ **Weil-Blakesley**



 2,5x10 mm N-1010.25

 4x10 mm N-1010.40

$\frac{1}{4}$ **Takahashi**



 2,5x10 mm N-1011.25

 4x10 mm N-1011.40

$\frac{1}{4}$ **Takahashi**



 N-0970.01

 N-0970.02

$\frac{1}{4}$ **Struycken**



 5 mm N-1050.05

 7 mm N-1050.07

 9 mm N-1050.09

 11 mm N-1050.11

$\frac{1}{4}$ **Hartmann**



 5 mm N-1054.05

 7 mm N-1054.07

 9 mm N-1054.09

$\frac{1}{4}$ **Schmeden**

Antrum Punch, retrograde cutting

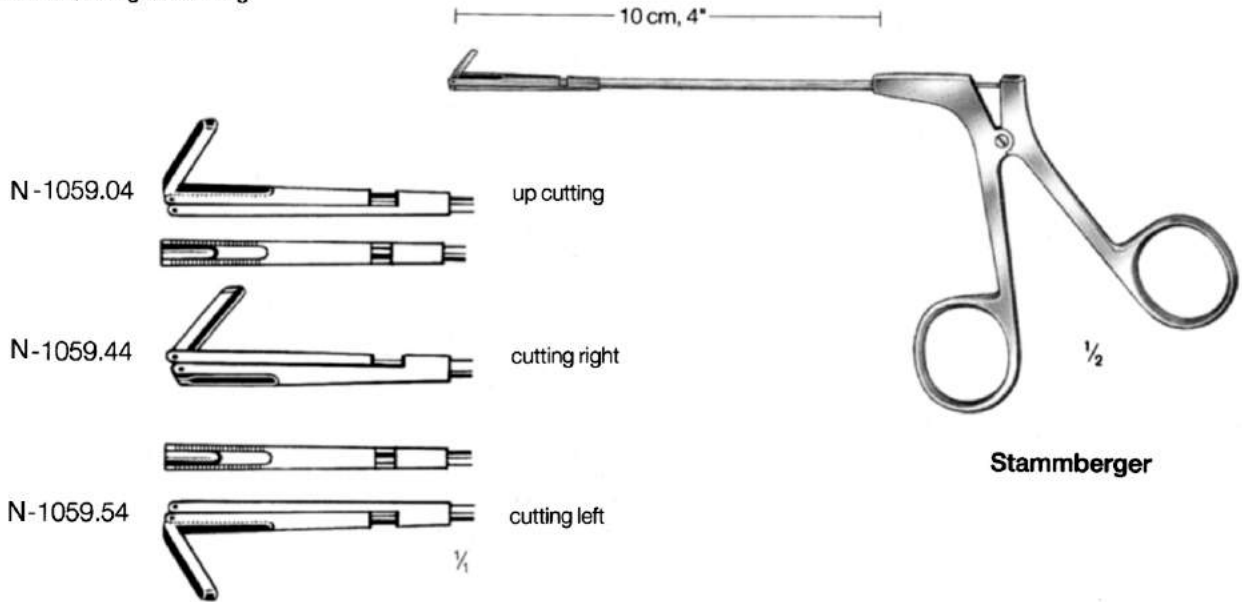

Septum Cutting Forceps

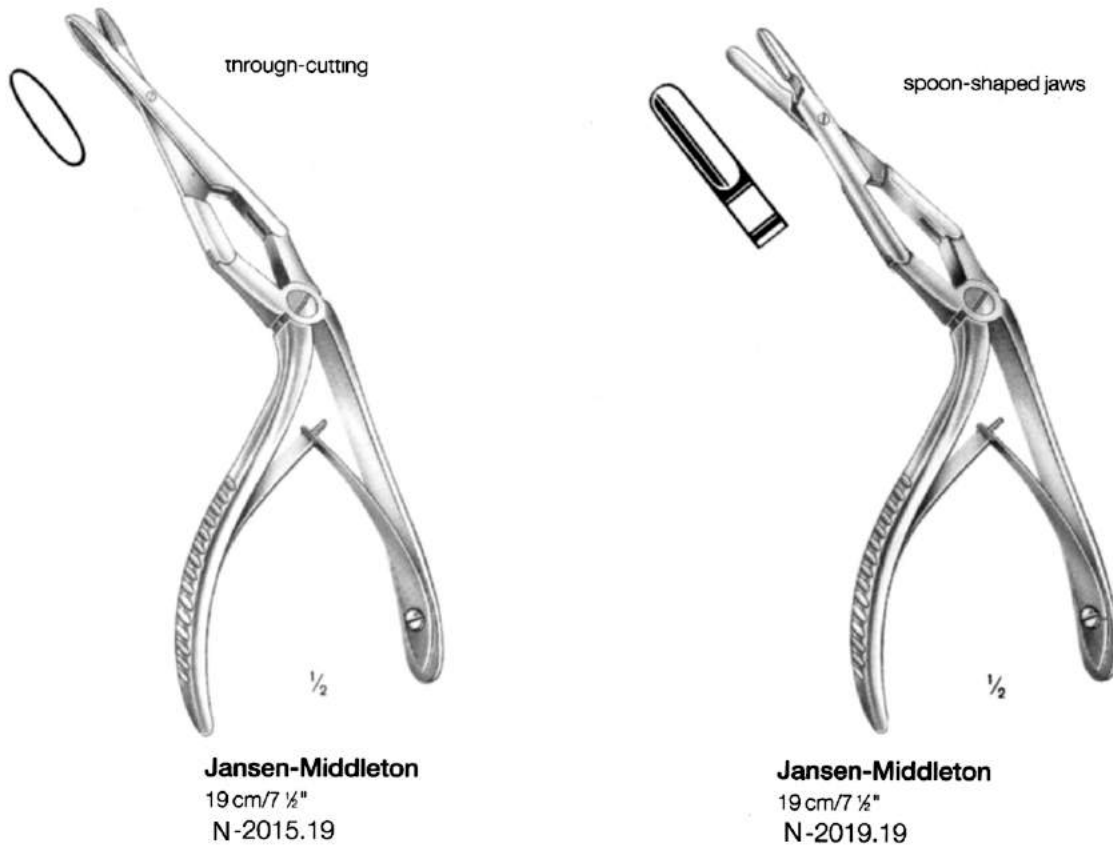



Fig.0  3x3mm N-3177.03



Fig.1  4x4mm N-3177.04

Fig.2  5x5mm N-3177.05

Fig.3  6x6mm N-3177.06



 1mm N-1106.10

 2mm N-1106.20

 3mm N-1106.30

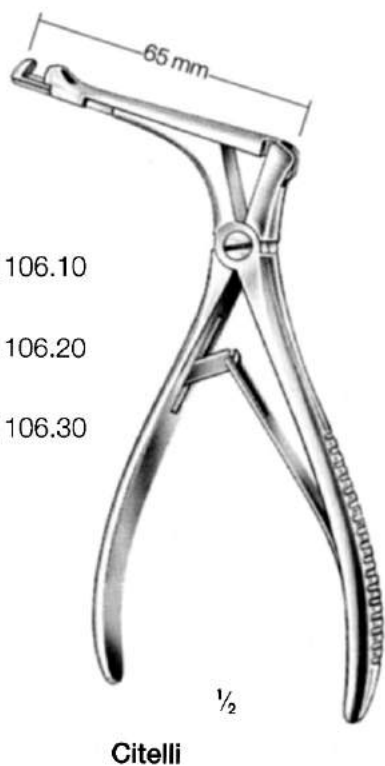



 1mm N-1109.10

 2mm N-1109.20

Atticus Punch

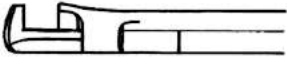
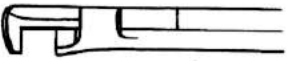

Sphenoid Punches

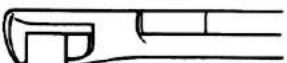
- | | | |
|-----|---|------------------------|
| ∩ |  | 3,5x3,5mm
N-3175.03 |
| U |  | 3,5x3,5mm
N-3175.13 |
| ∩ |  | 4,0x4,0mm
N-3175.04 |
| ¼ U |  | 4,0x4,0mm
N-3175.14 |

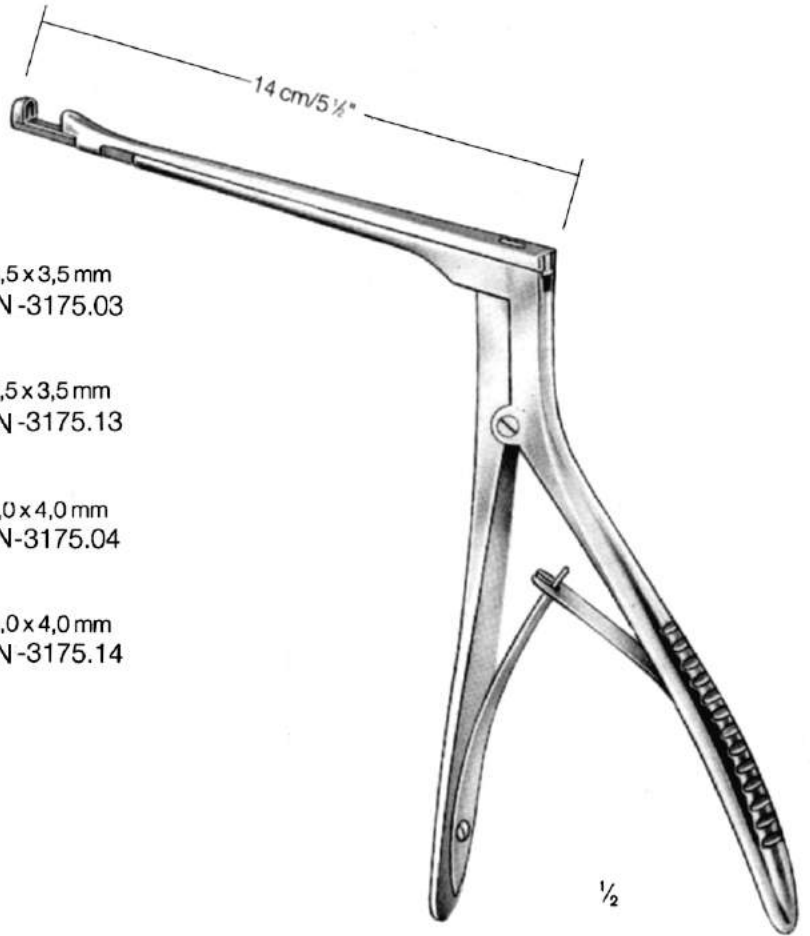

Hajek-Kofler

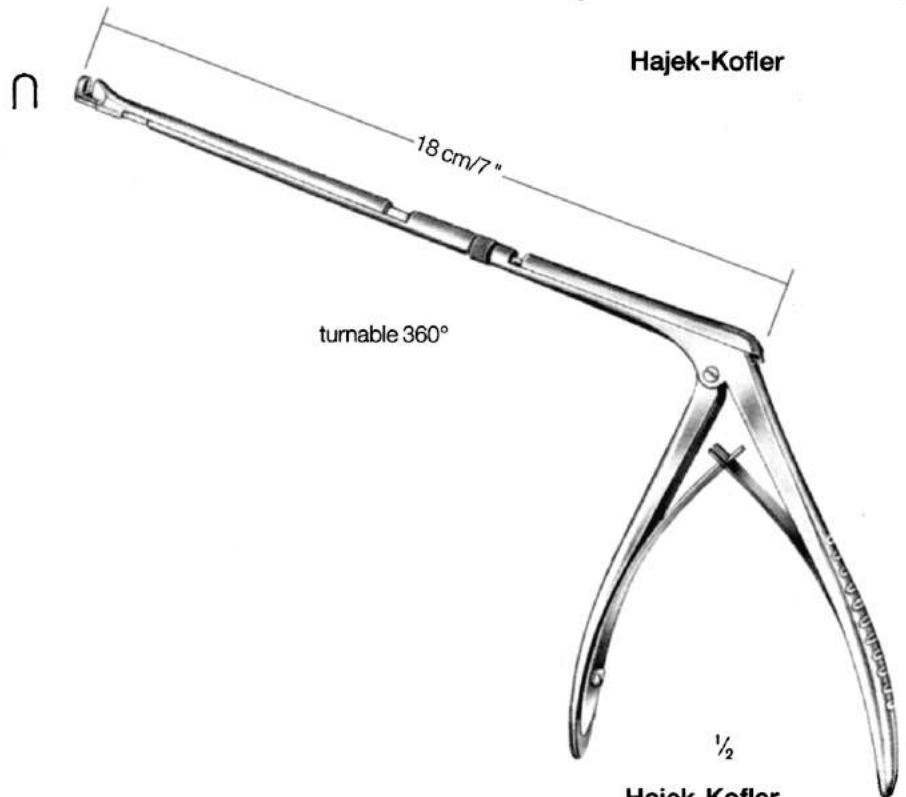

Hajek-Kofler
N-3188.03

Polypus, tampon and septum compression forceps
Pinces à polypes, porte-tampons et pour la cloison nasale
Pinzas para pólipos, taponamientos y el tabique nasal

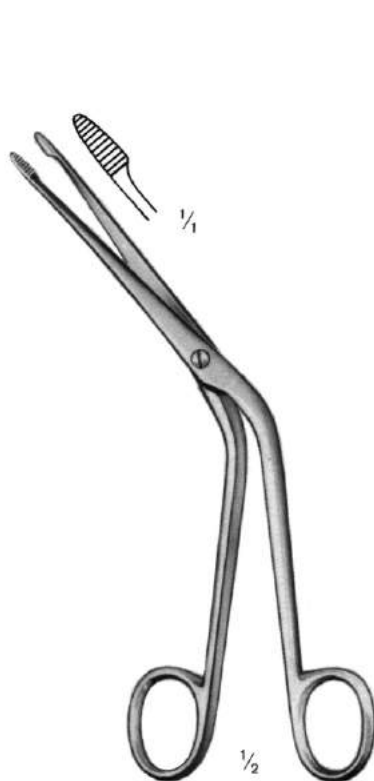

Hartmann
 16 cm/6 1/4"
 N-0810.16



Hartmann
 20 cm/8"
 N-0812.20

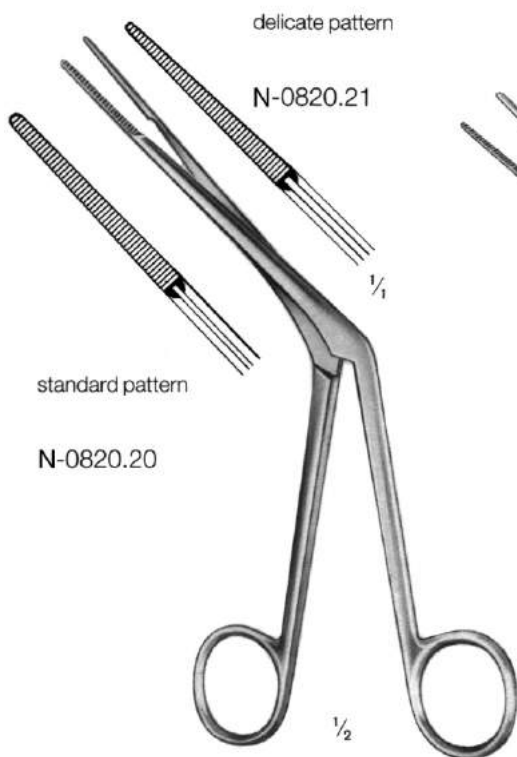

Westmacott
 20 cm/8"

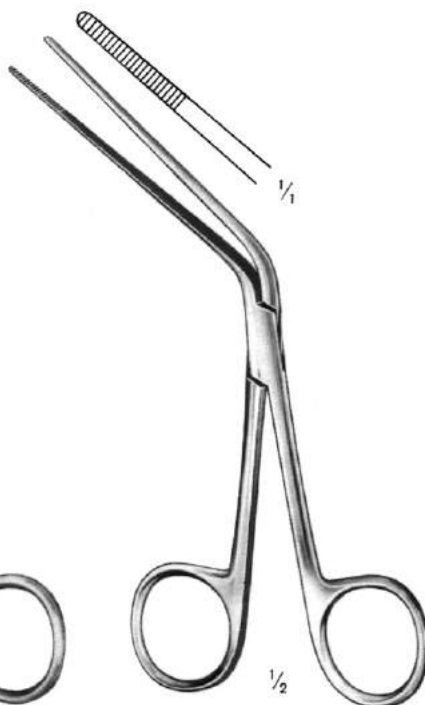

Tilley
 17 cm/6 1/4"
 N-0821.17

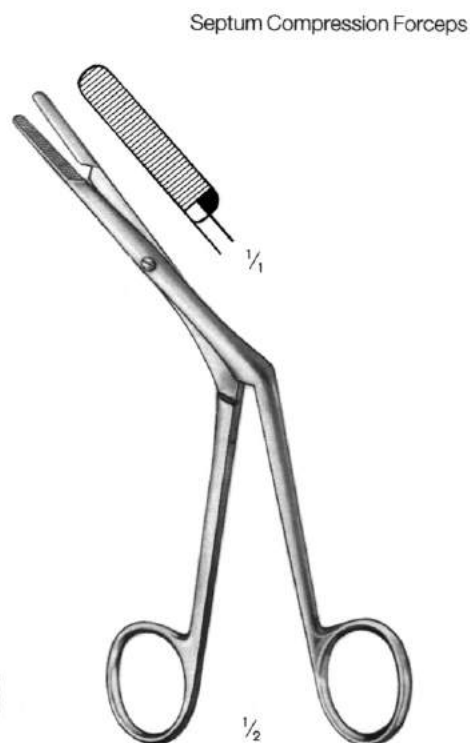

Killian
 17 cm/6 1/4"
 N-0829.01

Septum Compression Forceps

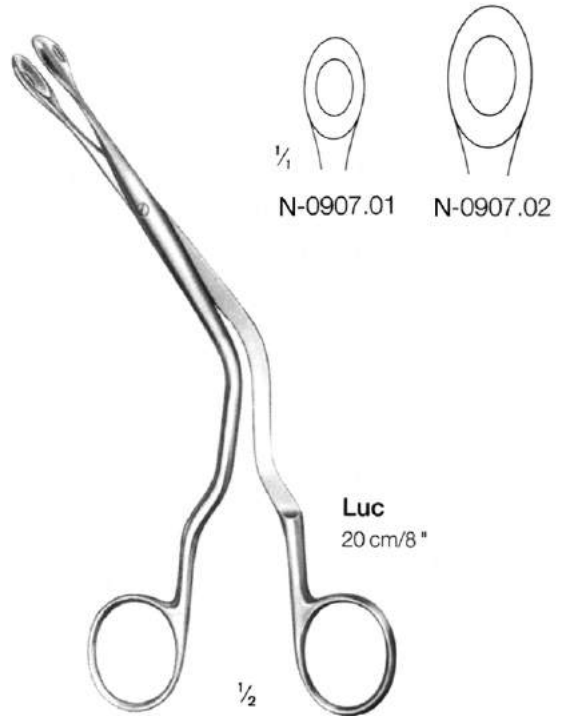
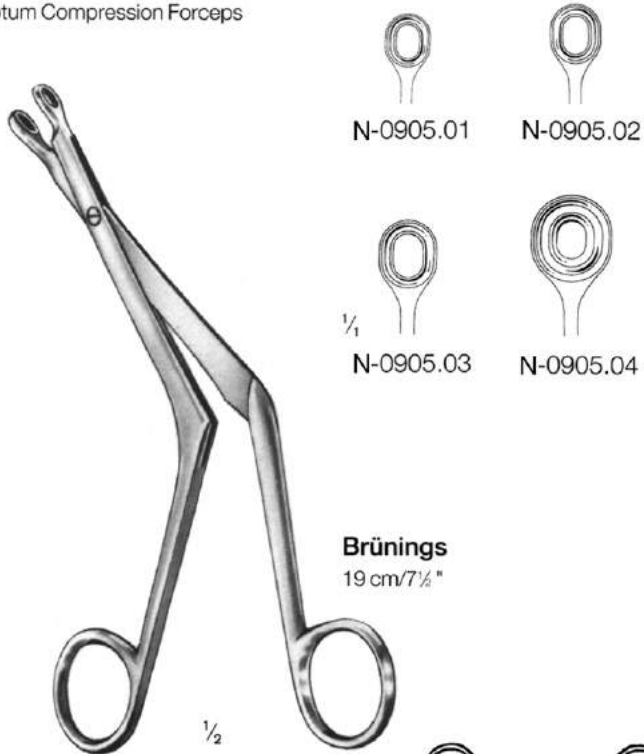

Vomer Forceps



Ethmoid Forceps

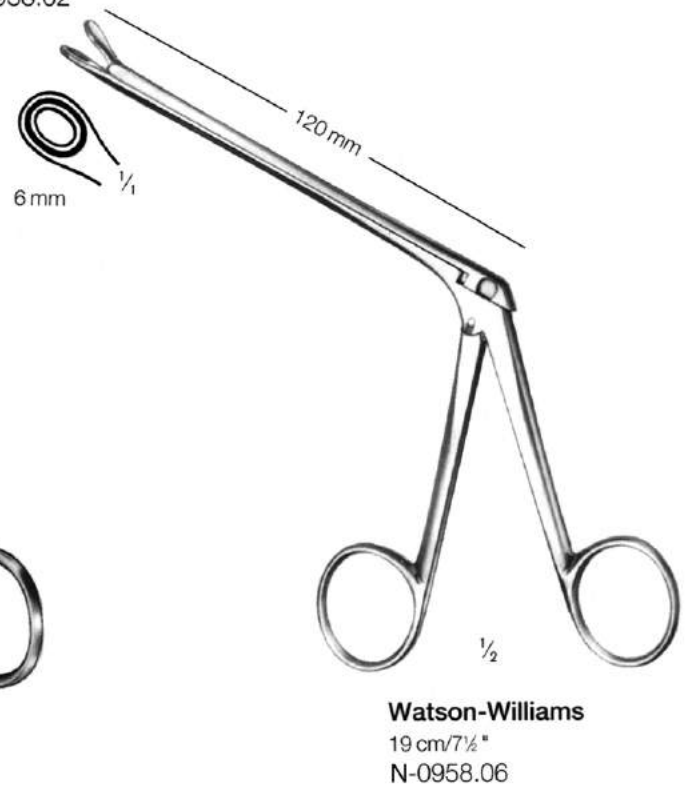

Adenoid curettes, nasal saws
Couteaux à végétations adénoïdes, scies nasales
Cuchillos para vegetaciones adenoides, sierras nasales

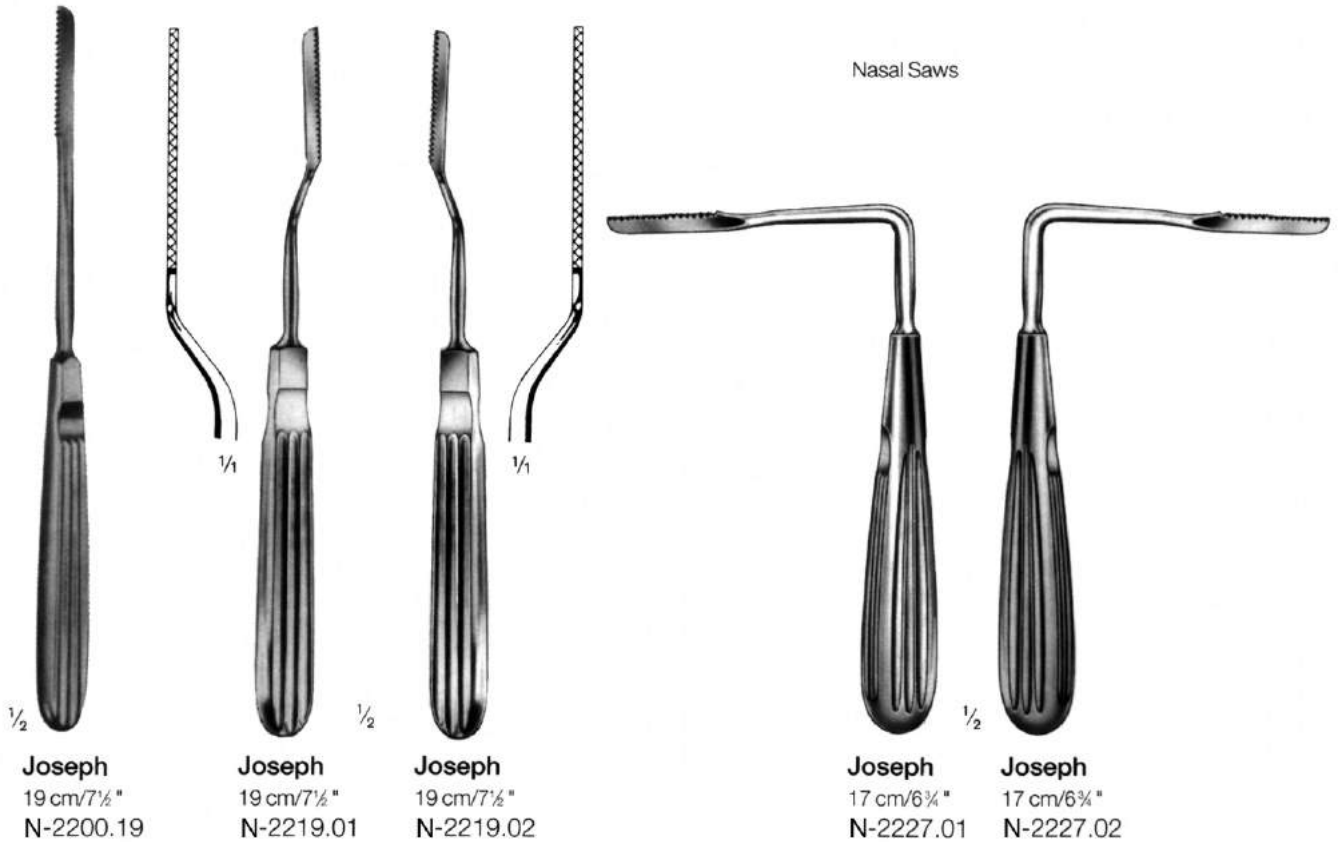
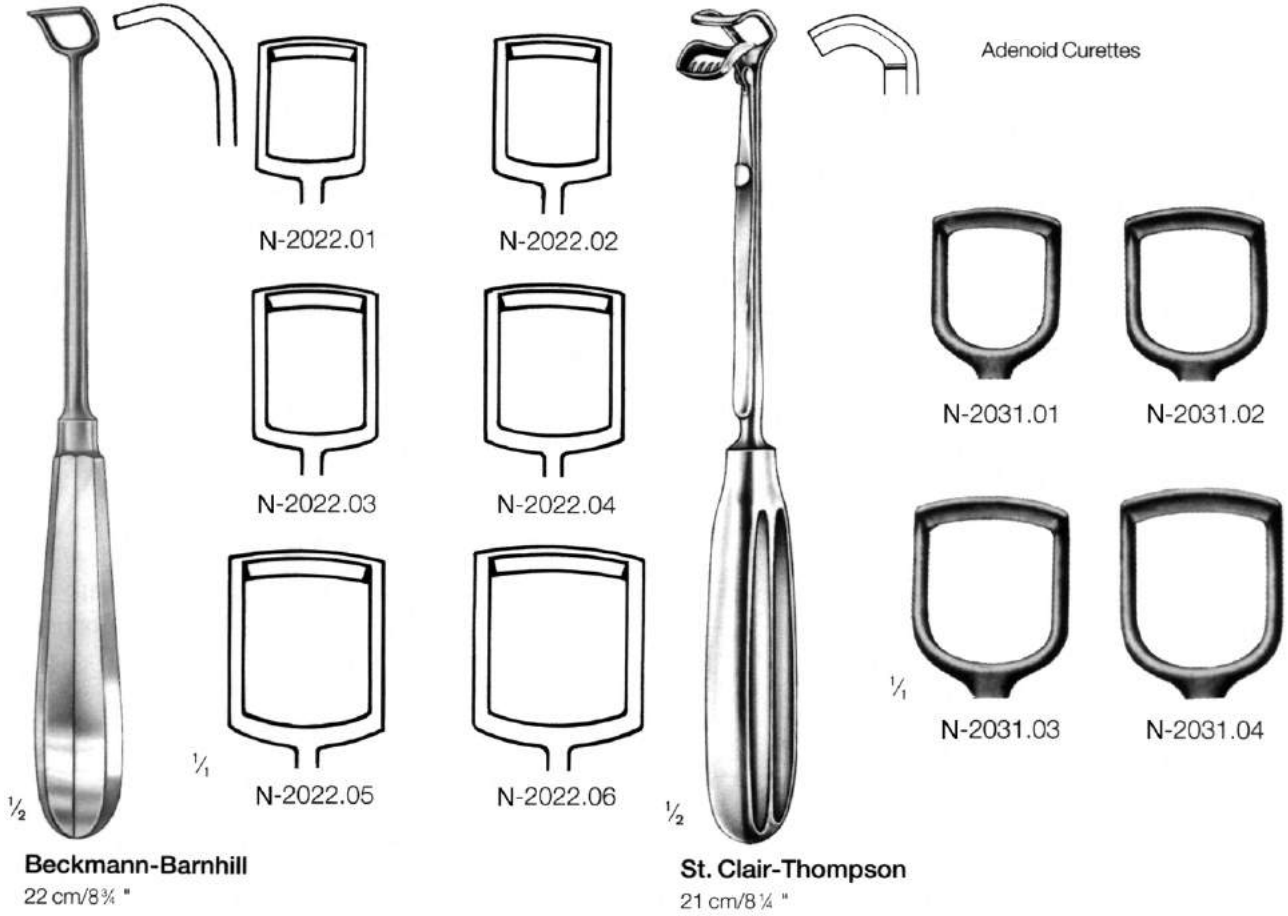



Krause
26 cm/10 1/4"
N-6525.10



Krause-Voss
26 cm/10 1/4"
N-6525.20



Lange-Wilde (Bruenings)
24 cm/9 1/2"
N-6525.30



La Force

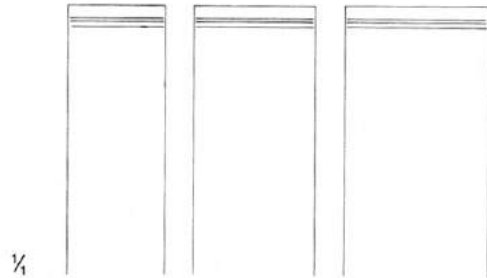

Fig. 1 Fig. 2 Fig. 3

Adenotomes with 2 unperforated blades		
13 mm N-4001.13	16 mm N-4001.16	19 mm N-4001.19
unperforated spare blades, each		
Fig. 1 N-4001.53	Fig. 2 N-4001.56	Fig. 3 N-4001.59

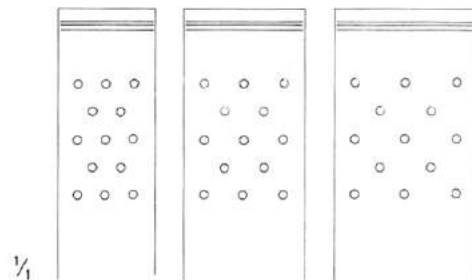

Fig. 1 Fig. 2 Fig. 3

Adenotomes with 2 perforated blades		
13 mm N-4001.33	16 mm N-4001.36	19 mm N-4001.39
perforated spare blades, each		
Fig. 1 N-4001.73	Fig. 2 N-4001.76	Fig. 3 N-4001.79



La Force

new simplified pattern,
 easily detachable

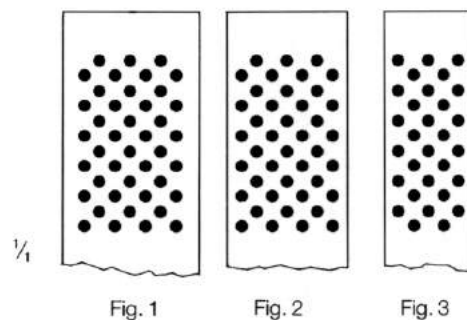
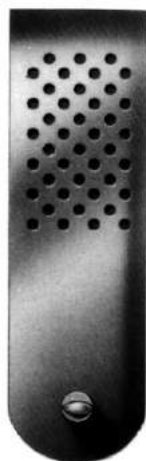

Adenotomes cpl. with 2 perforated blades		
18 mm N-4011.18	16 mm N-4012.16	12 mm N-4013.12
perforated spare blades, each		
Fig. 1 N-4011.68	Fig. 2 N-4012.66	Fig. 3 N-4013.62

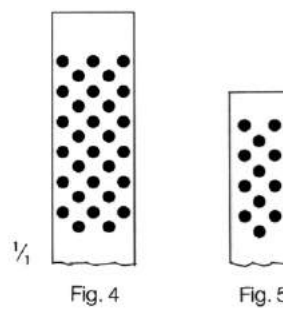

Adenotomes cpl. with 2 perforated blades	
11 mm N-4014.11	8 mm N-4015.08
perforated spare blades, each	
Fig. 4 N-4014.61	Fig. 5 N-4015.58

Mouth Gags



Replacement Silicon-Rubber Tooth Protectors,
 package of 5 pairs

N-0100.50 for N-0100.10
 N-0100.51 for N-0100.11
 N-0100.54 for N-0100.14

Doyen-Jansen (Molt)

N-0100.10 = 10 cm/4"
 N-0100.11 = 11 cm/4 1/2"
 N-0100.14 = 14 cm/5 1/2"



1/2

Tobold
 14,5 cm/5 3/4"
 N-0200.14



1/2

Moritz-Schmidt
 19 cm/7 1/2"
 N-0209.19



1/2

Hartmann
 15 cm/6"
 N-0215.15



1/2

Wieder
 12 cm/4 3/4"

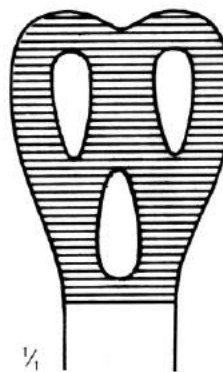

1/4

29 mm
 N-0224.29

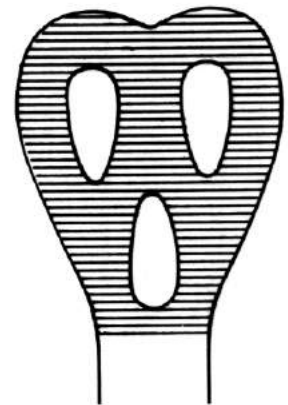

35 mm
 N-0224.35

Tongue depressors, tongue spatulas
Abaisse-langues, spatules buccales
Bajalenguas, espátulas bucales

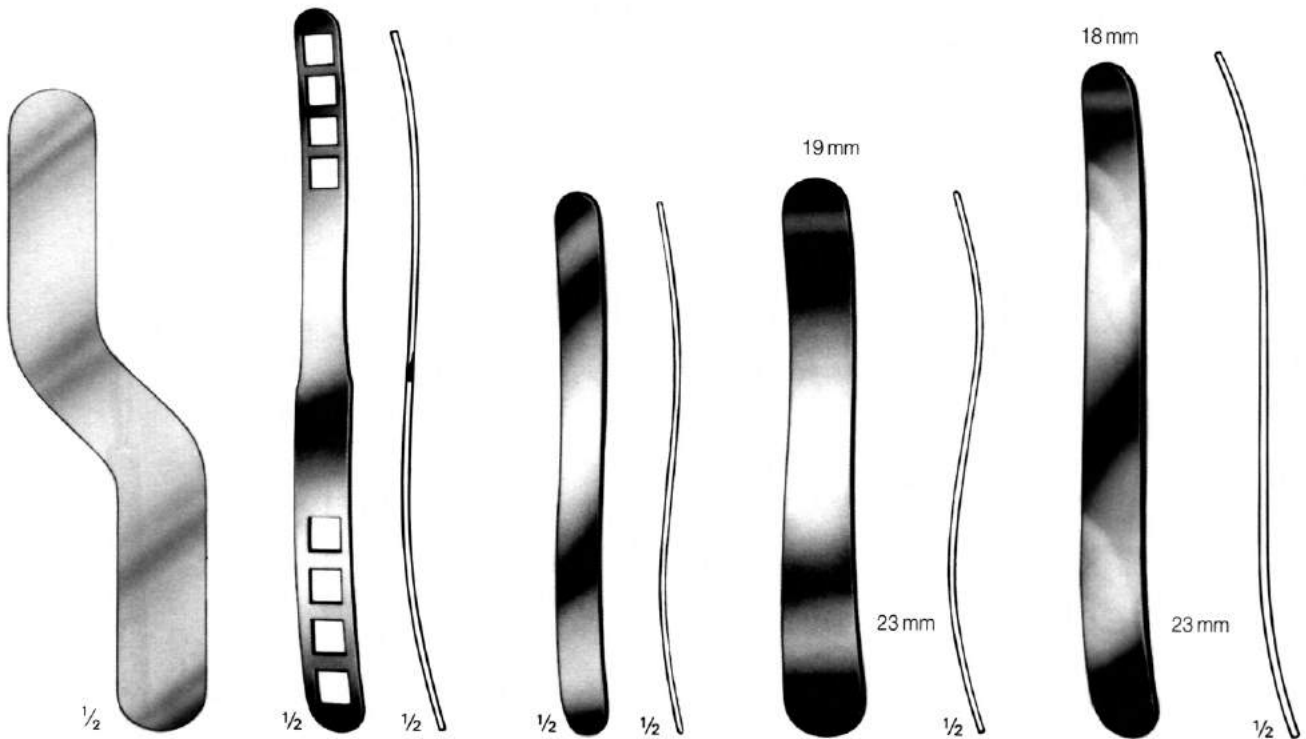

Dutch Pattern
 17 cm/6 3/4"
 N-0248.17

Bruenings
 19 cm/7 1/2"
 N-0250.19

14,5 cm/5 3/4"
 N-0251.14

Kroenig
 15 cm/6"
 N-0252.15

Buchwald
 18 cm/7"
 N-0252.18

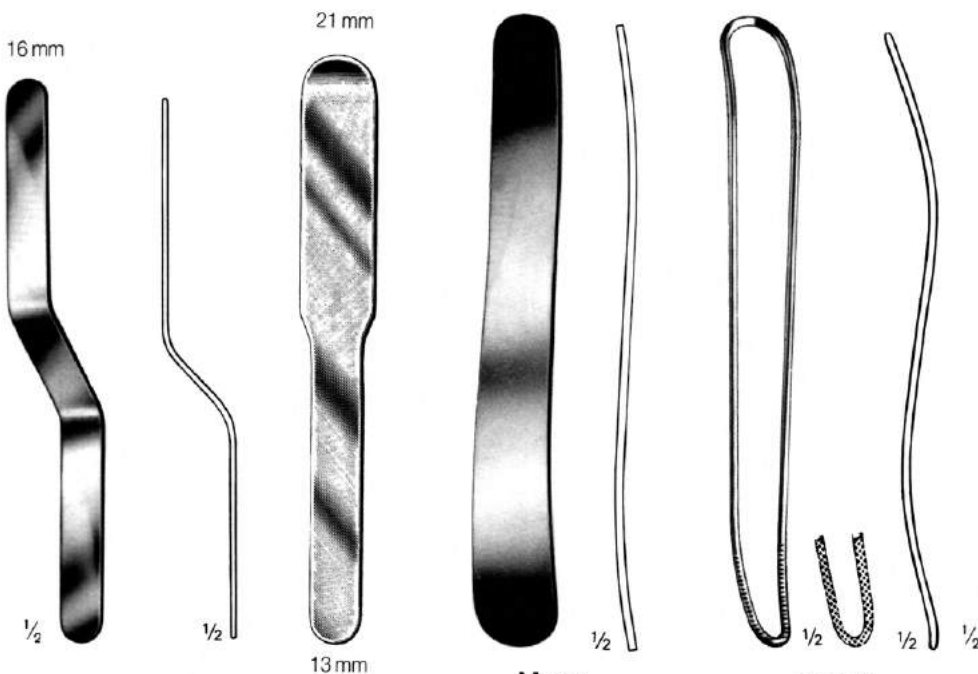

14 cm/5 1/4"
 N-0253.14

16 cm/6 1/4"
 N-0255.16

Mayo
 17 cm/6 3/4"
 N-0257.17

Frenzel
 16,5 cm/6 1/2"
 N-0265.16

Maunder

Oral Screws
 N-0380.40
 of wood
 N-0382.40
 of hard rubber



**Tonsillectomy
Amygdalectomie
Amigdalotomía**

Tonsillectomes

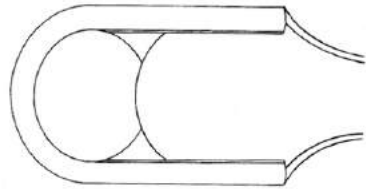

Fig. 1

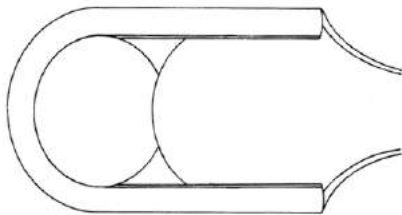

Fig. 2

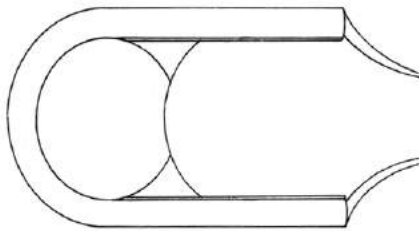
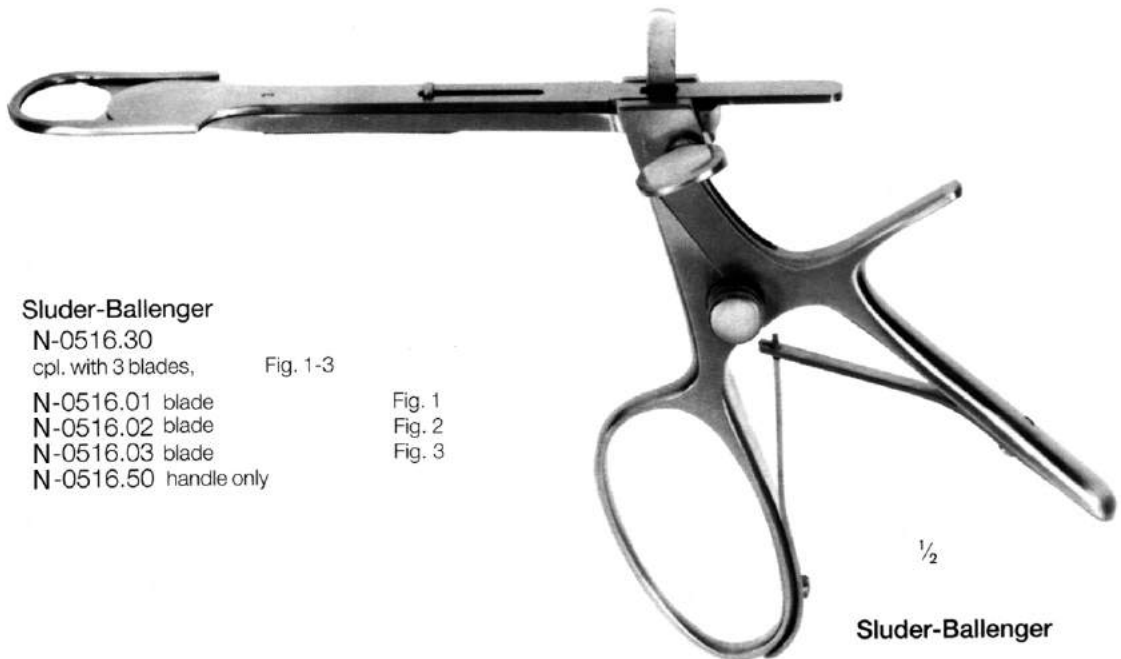

Fig. 3

1/4



Sluder-Ballenger

N-0516.30
cpl. with 3 blades,

Fig. 1-3

N-0516.01 blade

Fig. 1

N-0516.02 blade

Fig. 2

N-0516.03 blade

Fig. 3

N-0516.50 handle only

1/2

Sluder-Ballenger



Tonsillectomy
Amygdalectomie
Amigdalotomía

Tonsil Punch Forceps

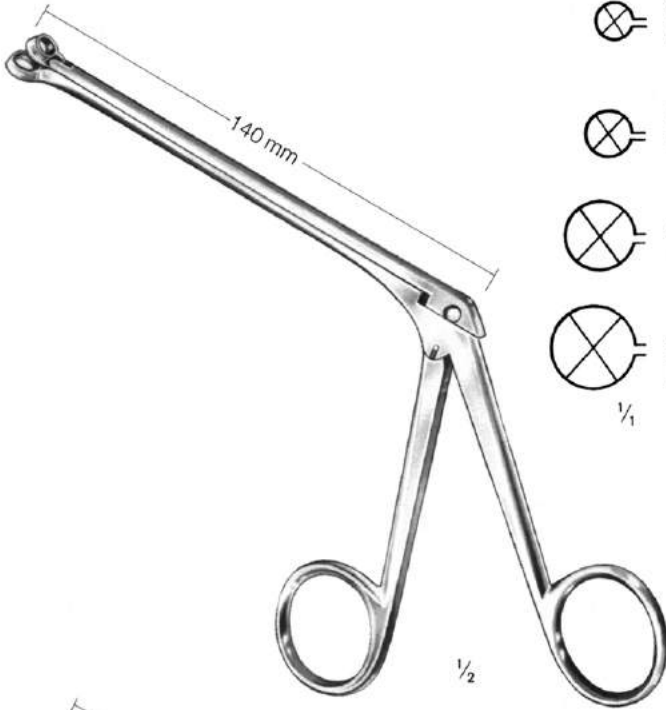

Ø 5 mm
N-5504.05

Ø 7 mm
N-5504.07

Ø 9 mm
N-5504.09

Ø 11 mm
N-5504.11
1/4

Ø 5 mm
N-5508.05

Ø 7 mm
N-5508.07

Ø 9 mm
N-5508.09
1/4



Schmeden

Hartmann

Peritonsillar Abscess Forceps

Tonsil Hemostat

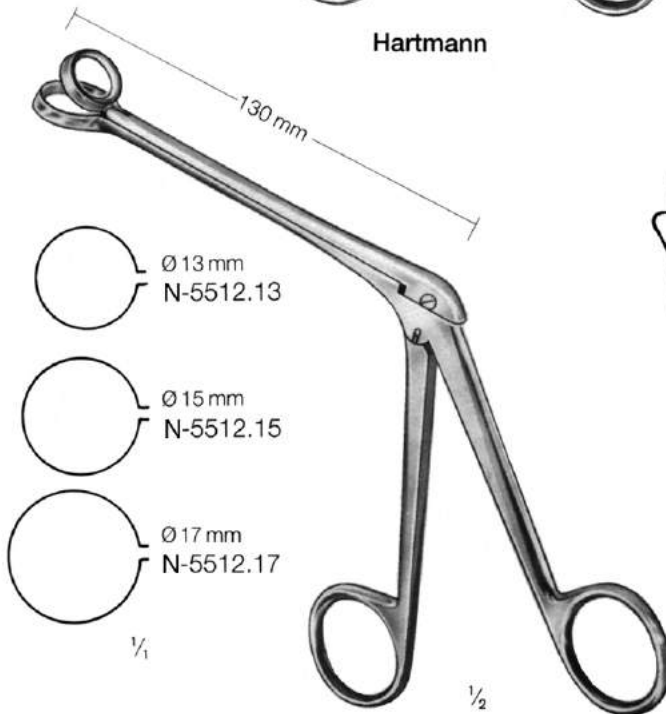

Ø 13 mm
N-5512.13

Ø 15 mm
N-5512.15

Ø 17 mm
N-5512.17
1/4

Hartmann



1/4

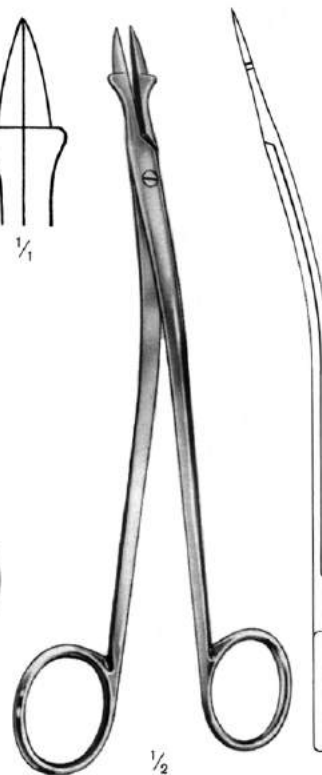

Thilenius
20 cm/8"
N-5525.20

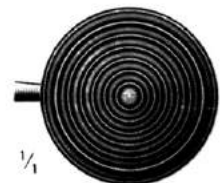

1/4



Corwin
14 cm/5 1/2"
N-5546.14



Tonsillectomy
Amygdalectomie
Amigdalotomía

Tonsil Dissectors, Retractors and Elevators

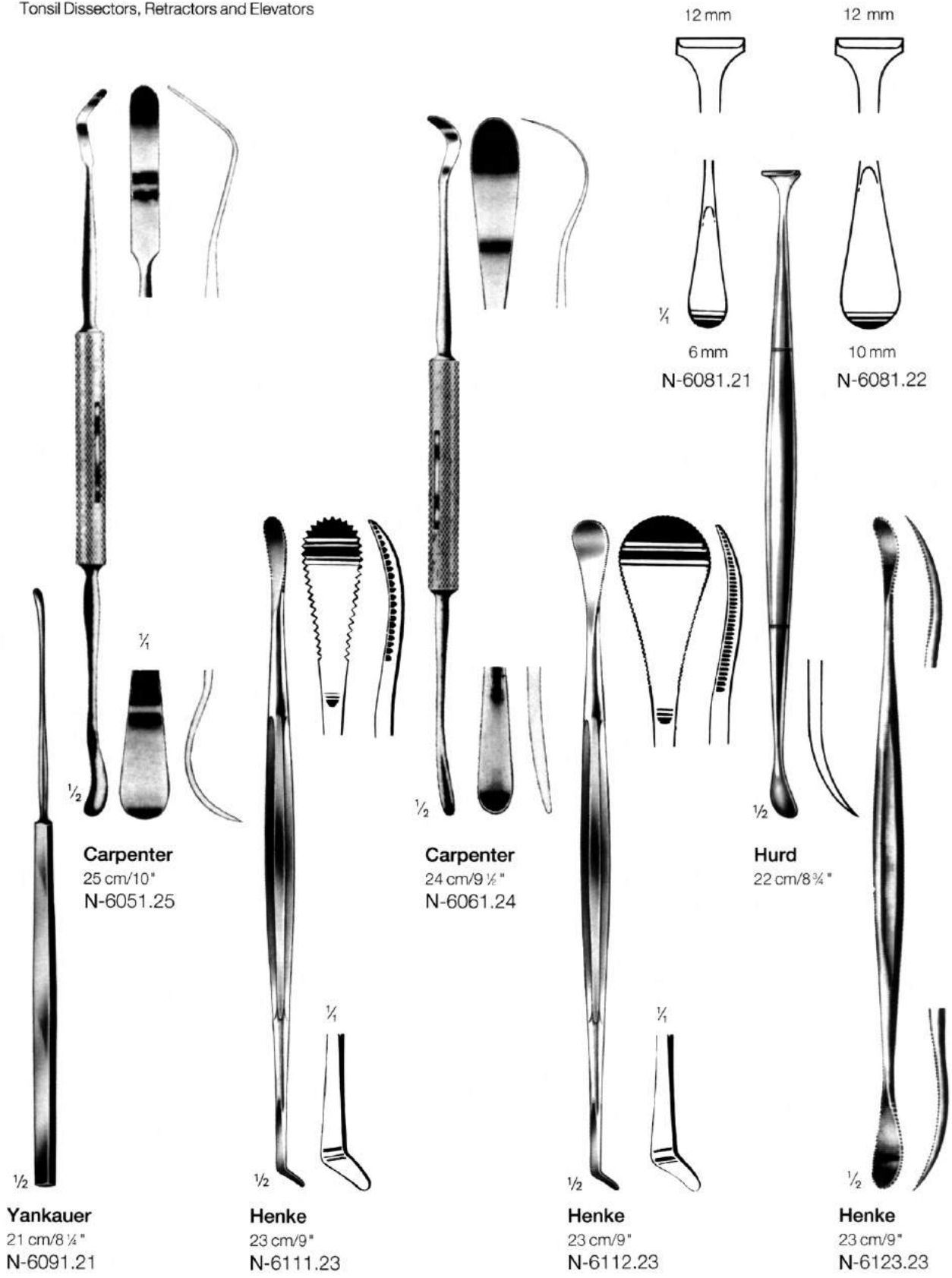

Tonsil Gauze Packer

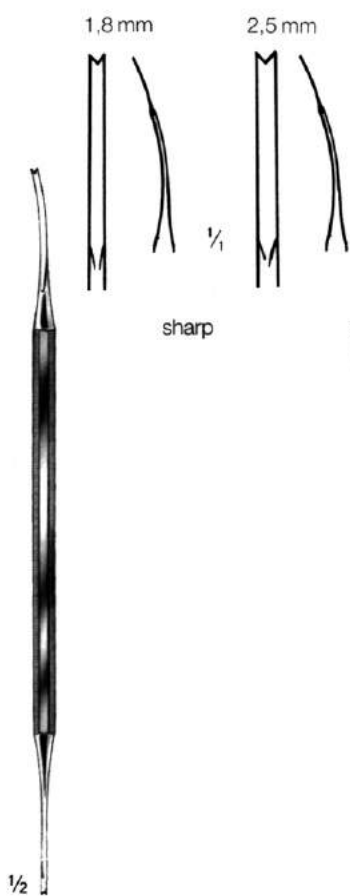

Luniatschek

19 cm/7 1/2"
N-6149.18 = 1,8 mm
N-6149.25 = 2,5 mm

Nasopharyngeal and Uvula Retractors



Love

15 cm/6" B
N-6155.18 = 18 mm
N-6155.20 = 20 mm
N-6155.22 = 22 mm

Soft Palate Retractor



Nager

23 cm/9"
N-6243.23

Velum Retractor



Haslinger

17 cm/6 3/4"
N-6253.17



Tonsillectomy
Amygdalectomie
Amigdalotomía

Adenoid Punches

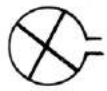

Ø 11 mm

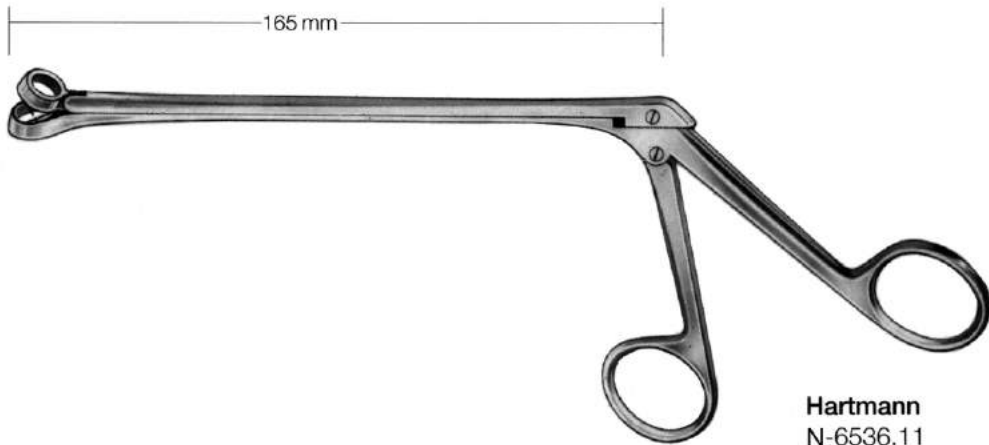

Hartmann
N-6536.11

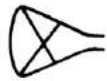

11 mm

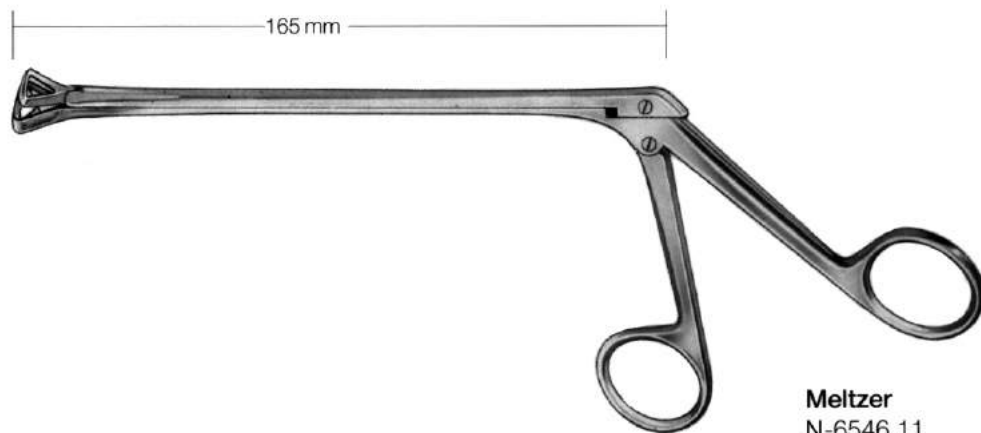

Meltzer
N-6546.11

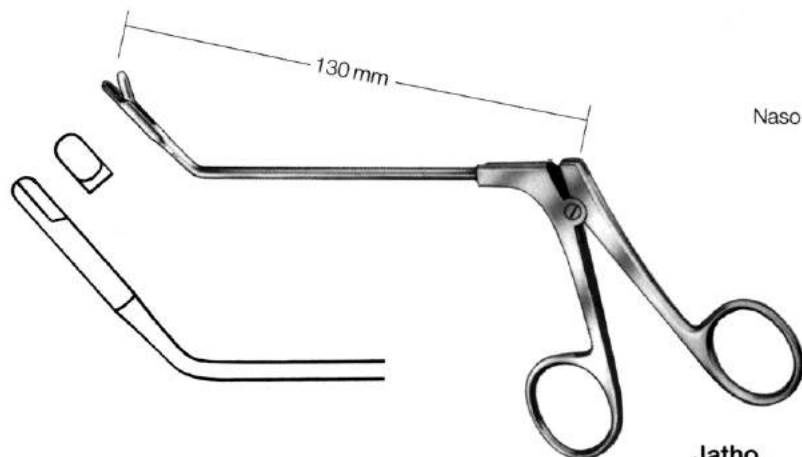

Naso-Pharyngeal Forceps

Jatho
N-6551.13



Tracheal dilators

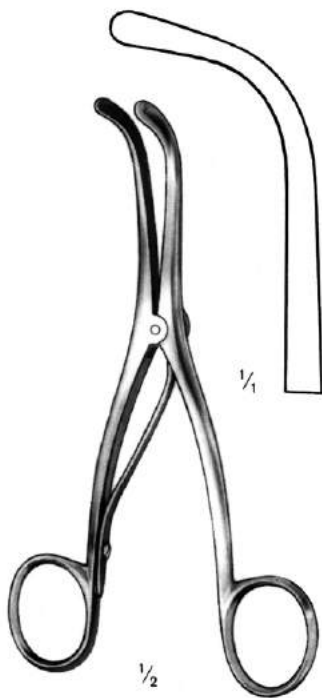

Trousseau
14 cm/5 $\frac{1}{2}$ "
N-7014.05

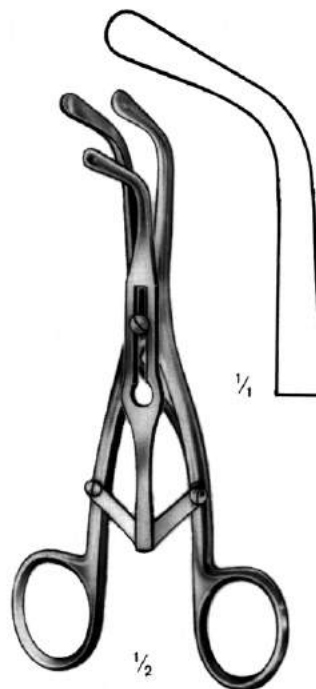

Laborde
14 cm/5 $\frac{1}{2}$ "
N-7050.14

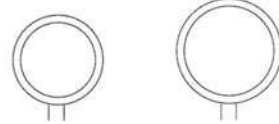

Ø 12 mm
 N-1402.12

Ø 14 mm
 N-1402.14

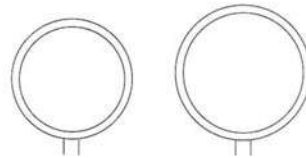

1/4

Ø 16 mm
 N-1402.16

Ø 18 mm
 N-1402.18

Epiglottis Retractor



1/2

Reichert
 24 cm/9 1/2"
 N-1351.24

Rhinoscopic Mirrors



1/2

Michel
 25 cm/10"
 N-1402.##

Laryngeal Mirrors and Handles

Handles for Laryngeal Mirrors

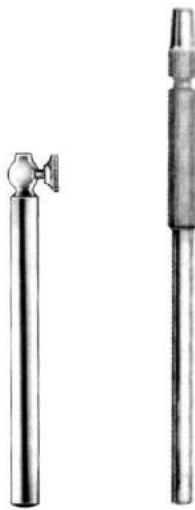

N-1405.20 N-1405.42

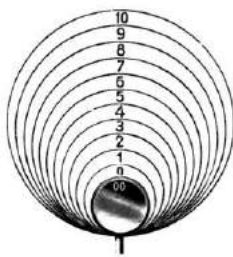

Fig. 000 = Ø 6 mm
 Fig. 00 = Ø 8 mm
 Fig. 0 = Ø 10 mm
 Fig. 1 = Ø 12 mm
 Fig. 2 = Ø 14 mm
 Fig. 3 = Ø 16 mm
 Fig. 4 = Ø 18 mm
 Fig. 5 = Ø 20 mm
 Fig. 6 = Ø 22 mm
 Fig. 7 = Ø 24 mm
 Fig. 8 = Ø 26 mm
 Fig. 9 = Ø 28 mm
 Fig. 10 = Ø 30 mm

without handle



N-1404.06
 N-1404.08
 N-1404.10
 N-1404.12
 N-1404.14
 N-1404.16
 N-1404.18
 N-1404.20
 N-1404.22
 N-1404.24
 N-1404.26
 N-1404.28
 N-1404.30

with solid hexagonal handle



N-1410.06
 N-1410.08
 N-1410.10
 N-1410.12
 N-1410.14
 N-1410.16
 N-1410.18
 N-1410.20
 N-1410.22
 N-1410.24
 N-1410.26
 N-1410.28
 N-1410.30

with solid round handle



N-1412.06
 N-1412.08
 N-1412.10
 N-1412.12
 N-1412.14
 N-1412.16
 N-1412.18
 N-1412.20
 N-1412.22
 N-1412.24
 N-1412.26
 N-1412.28
 N-1412.30

Instruments for endo-laryngeal Micro Surgery

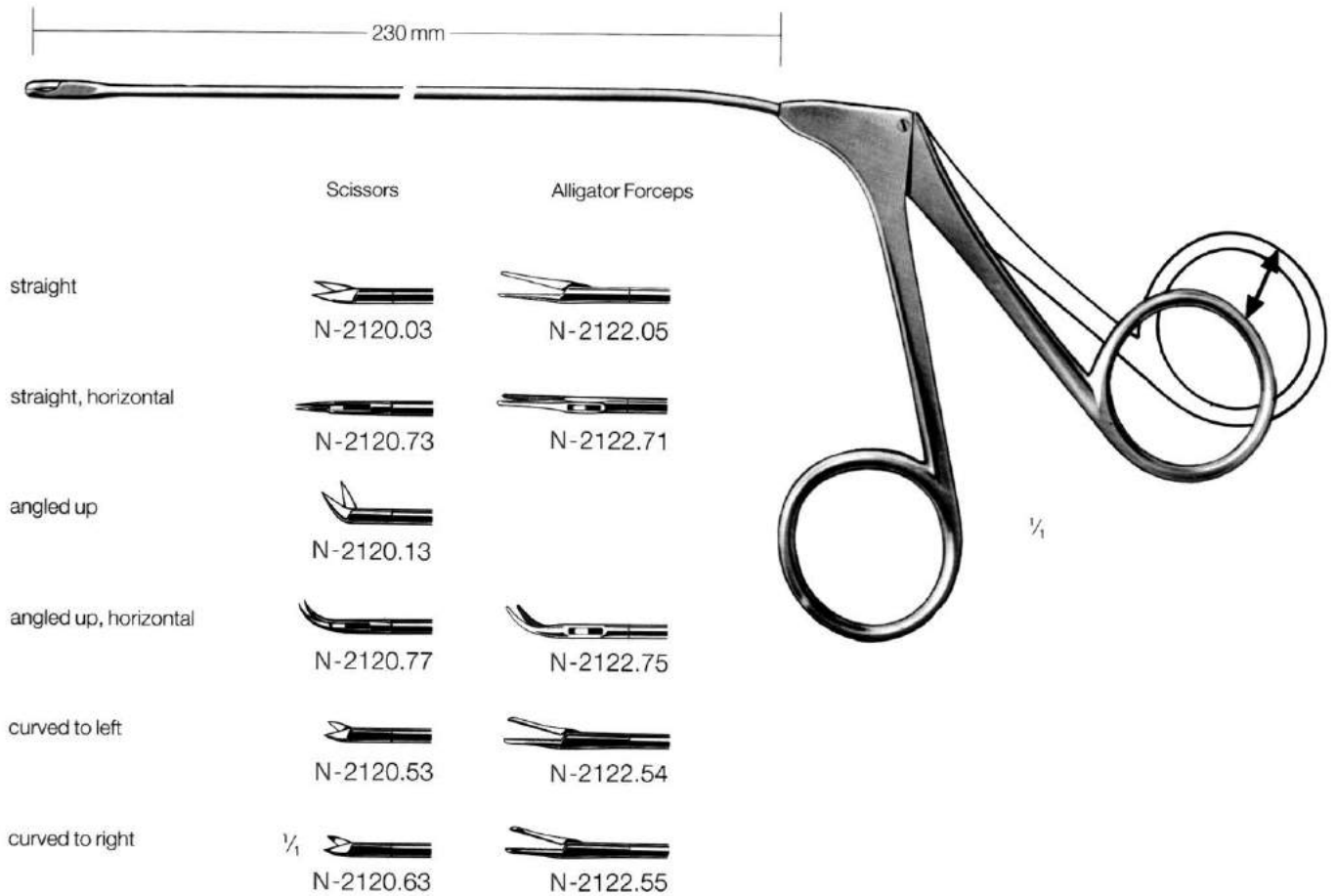













Delicate Cup-shaped Forceps, Ø 2,5 mm



Forceps with tubular shafts for Laryngoscopy



Diameter of tube: 1.5 mm

- | | | |
|---|-----------|------------------------------|
|  | | 1= N-3435.01 |
|  | 2 mm | 2= N-3535.02 |
|  | 3 mm | 1= N-3435.03
2= N-3535.03 |
|  | | 1= N-3435.05
2= N-3535.05 |
|  | | 1= N-3435.08
2= N-3535.08 |
|  | | 1= N-3435.09
2= N-3535.09 |
|  | oval 2 mm | 1= N-3435.11 |
|  | 3x5 mm | 1= N-3435.12
2= N-3535.12 |
|  | 3 mm | 1= N-3435.50 |
|  | 3 mm | 1= N-3435.54 |
|  | 3 mm | 1= N-3435.55 |
|  | 3 mm | 1= N-3435.75 |

1 = one part of jaw movable

2 = both part of jaw movable





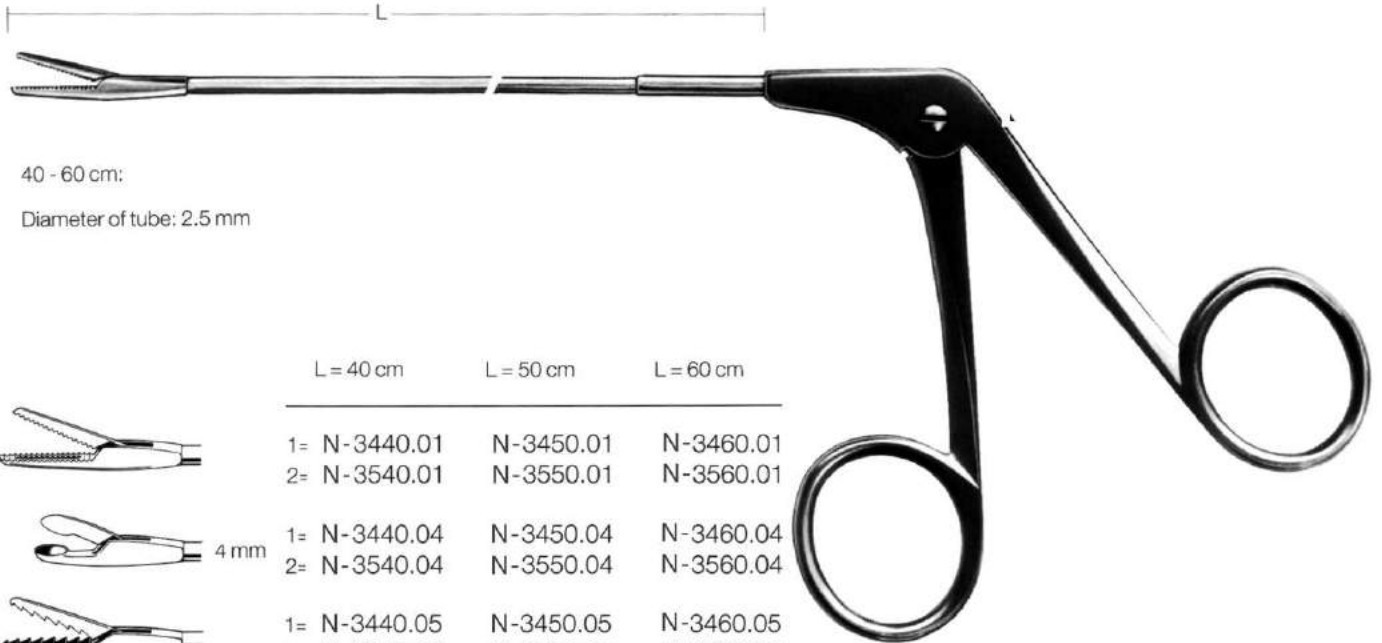





1/1

Forceps with tubular shafts for Laryngo-Broncho-Esophagoscopy



40 - 60 cm:

Diameter of tube: 2.5 mm

	L = 40 cm	L = 50 cm	L = 60 cm	
	1= N-3440.01	N-3450.01	N-3460.01	
	2= N-3540.01	N-3550.01	N-3560.01	
	1= N-3440.04	N-3450.04	N-3460.04	
4 mm	2= N-3540.04	N-3550.04	N-3560.04	
	1= N-3440.05	N-3450.05	N-3460.05	
	2= N-3540.05	N-3550.05	N-3560.05	
	1= N-3440.08	N-3450.08	N-3460.08	
	2= N-3540.08	N-3550.08	N-3560.08	
	1= N-3440.09	N-3450.09	N-3460.09	
	2= N-3540.09	N-3550.09	N-3560.09	1 = one part of jaw movable
	3 x 6 mm 1= N-3440.36	N-3450.36	N-3460.36	
	4 x 6 mm 1= N-3440.46	N-3450.46	N-3460.46	
	4 x 8 mm 1= N-3440.48	N-3450.48	N-3460.48	2 = both part of jaw movable
	4 mm 1= N-3440.50	N-3450.50	N-3460.50	
	4 mm 1= N-3440.54	N-3450.54	N-3460.54	
	4 mm 1= N-3440.55	N-3450.55	N-3460.55	
	4 mm 1= N-3440.75	N-3450.75	N-3460.75	
	1= N-3440.92	N-3450.92	N-3460.92	
$\frac{1}{4}$ Tumor Punch				

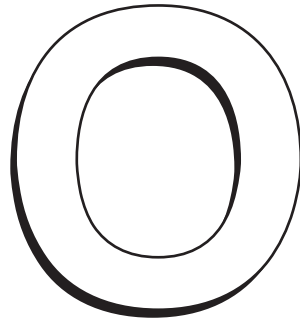

- Diagnostics
- Diagnostic
- Diagnostico

Percussion and Reflex Hammers



Stethoscopes

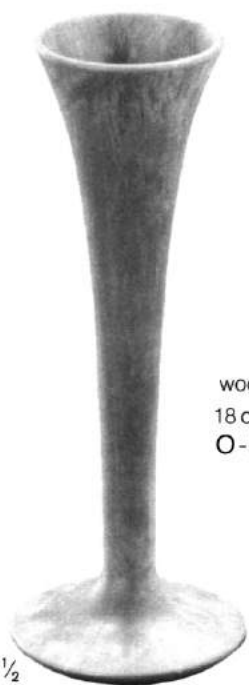

wood
18 cm/7"
O-0230.25

1/2

Pinard



aluminium
15 cm/6"
O-0230.26

Pinard

c 128



Hartmann

- c 128 O-0010.31
- c¹ 256 O-0010.32
- c² 512 O-0010.33
- c³ 1024 O-0010.34
- c⁴ 2048 O-0010.35
- c⁵ 4096 O-0010.37

c⁵ 4096



c 128



Lucae

- c 128 O-0020.41
- c¹ 256 O-0020.42
- c² 512 O-0020.43
- c³ 1024 O-0020.44
- c⁴ 2048 O-0020.45
- c⁵ 4096 O-0020.46

c⁵ 4096



Hartmann

O-0011.81

Set of 5 Tuning Forks
 consisting of:

- c 128 O-0010.31
- c¹ 256 O-0010.32
- c² 512 O-0010.33
- c³ 1024 O-0010.34
- c⁴ 2048 O-0010.35



French

C-₂ 16
 O-0025.01



French

C-₁ 32
 O-0025.02



Hartmann

C 64
 O-0025.03



Hartmann

c 128
 O-0025.04



Hartmann

c¹ 256
 O-0025.05



Ziegler
Head Mirrors
O-3020.09 90 mm Ø
O-3020.10 100 mm Ø

Mouth Gags



1/2

Denhart
 12 cm/4 3/4"
 O-5100.12

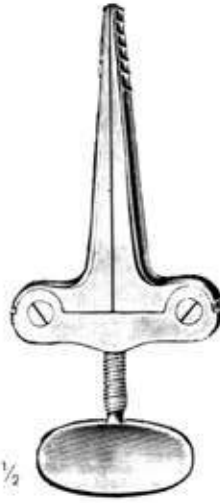

1/2

Heister
 13 cm/5"
 O-5104.13



1/2

Roser-König
 16 cm/6 1/4"
 O-5110.16

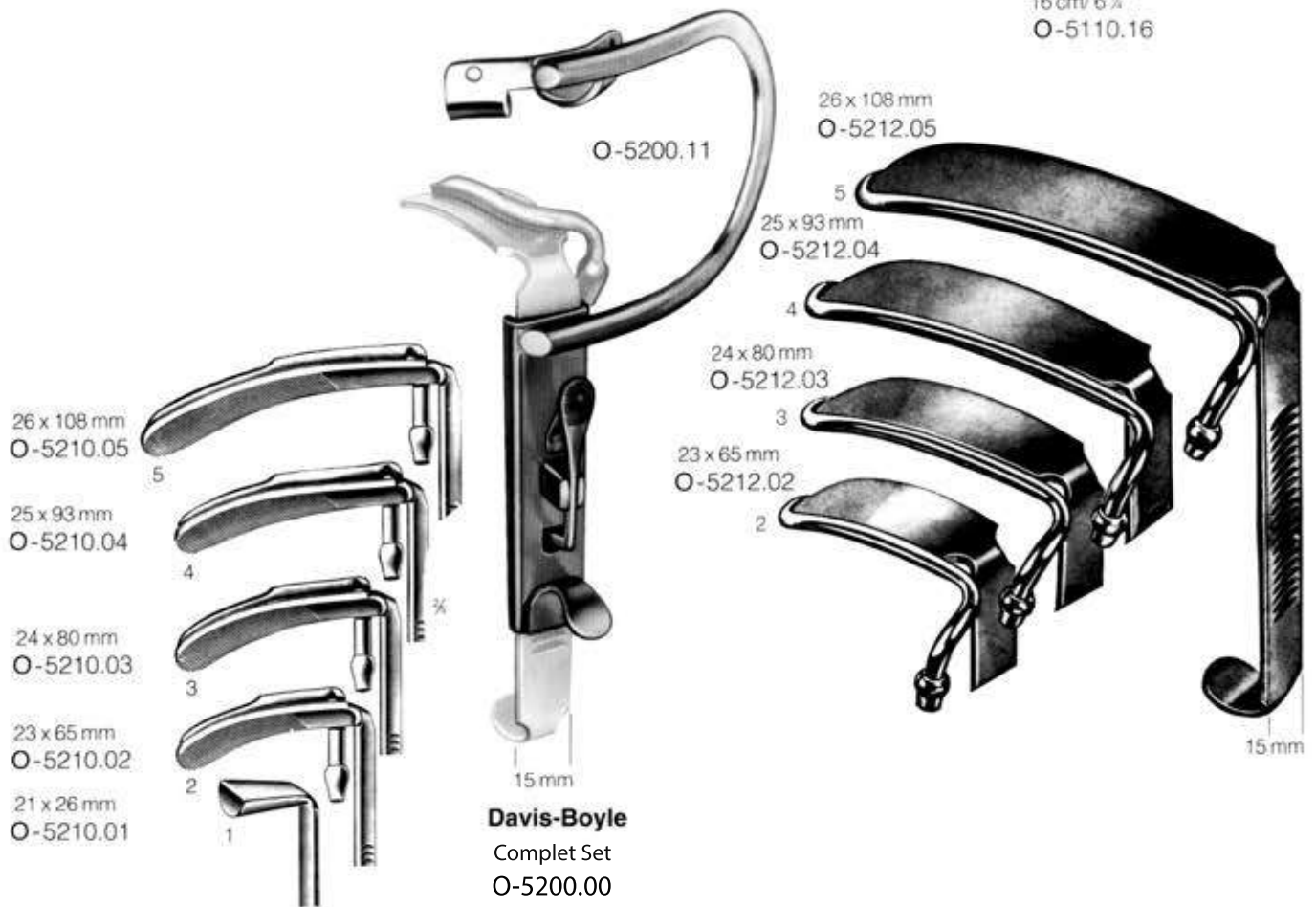

26 x 108 mm
 O-5210.05

25 x 93 mm
 O-5210.04

24 x 80 mm
 O-5210.03

23 x 65 mm
 O-5210.02

21 x 26 mm
 O-5210.01

5

4

3

2

1

O-5200.11

26 x 108 mm
 O-5212.05

5
 25 x 93 mm
 O-5212.04

4
 24 x 80 mm
 O-5212.03

3
 23 x 65 mm
 O-5212.02

2

15 mm

Davis-Boyle
 Complet Set
 O-5200.00

15 mm

with ether tube

without ether tube



O-5203.10

Mclvor
set cpl.
O-5230.00

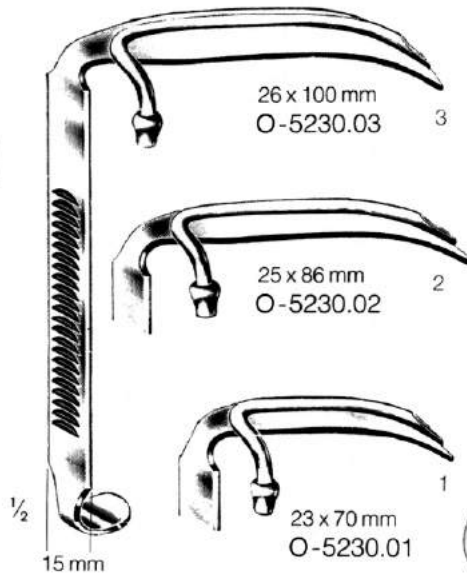

26 x 100 mm
O-5230.03

25 x 86 mm
O-5230.02

23 x 70 mm
O-5230.01

1/2

15 mm

Other patterns on request

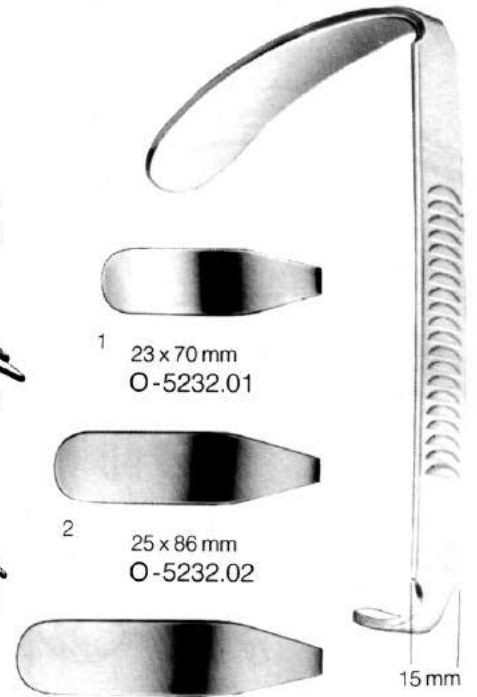

1
23 x 70 mm
O-5232.01

2
25 x 86 mm
O-5232.02

3
26 x 100 mm
O-5232.03

15 mm

Mclvor



O-5202.10

Kilner-Doughty
set cpl.
O-5240.00



37 x 80 mm
O-5240.03

32 x 75 mm
O-5240.02

28 x 65 mm
O-5240.01

1/2

15 mm



37 x 80 mm
O-5255.03

32 x 75 mm
O-5255.02

28 x 65 mm
O-5255.01

3

2

1

15 mm

Gast

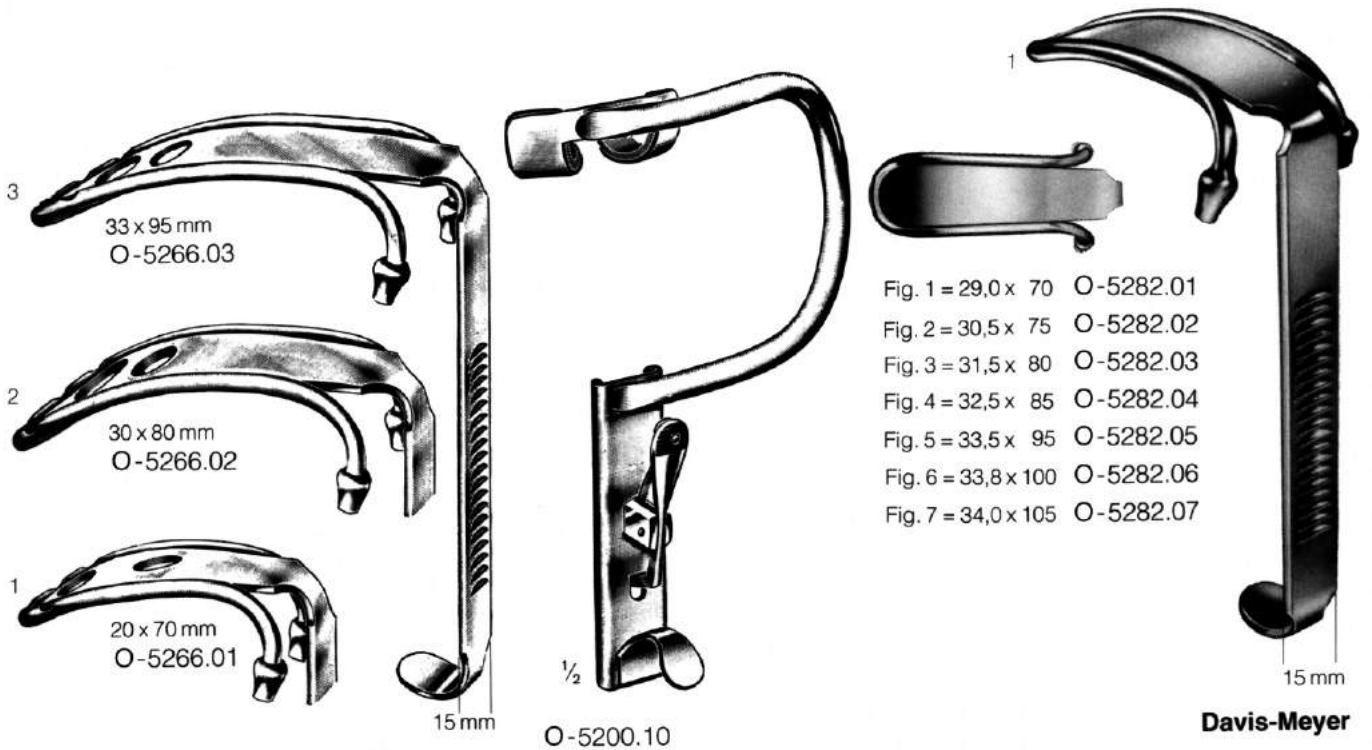

Negus

set cpl.
O-5266.00

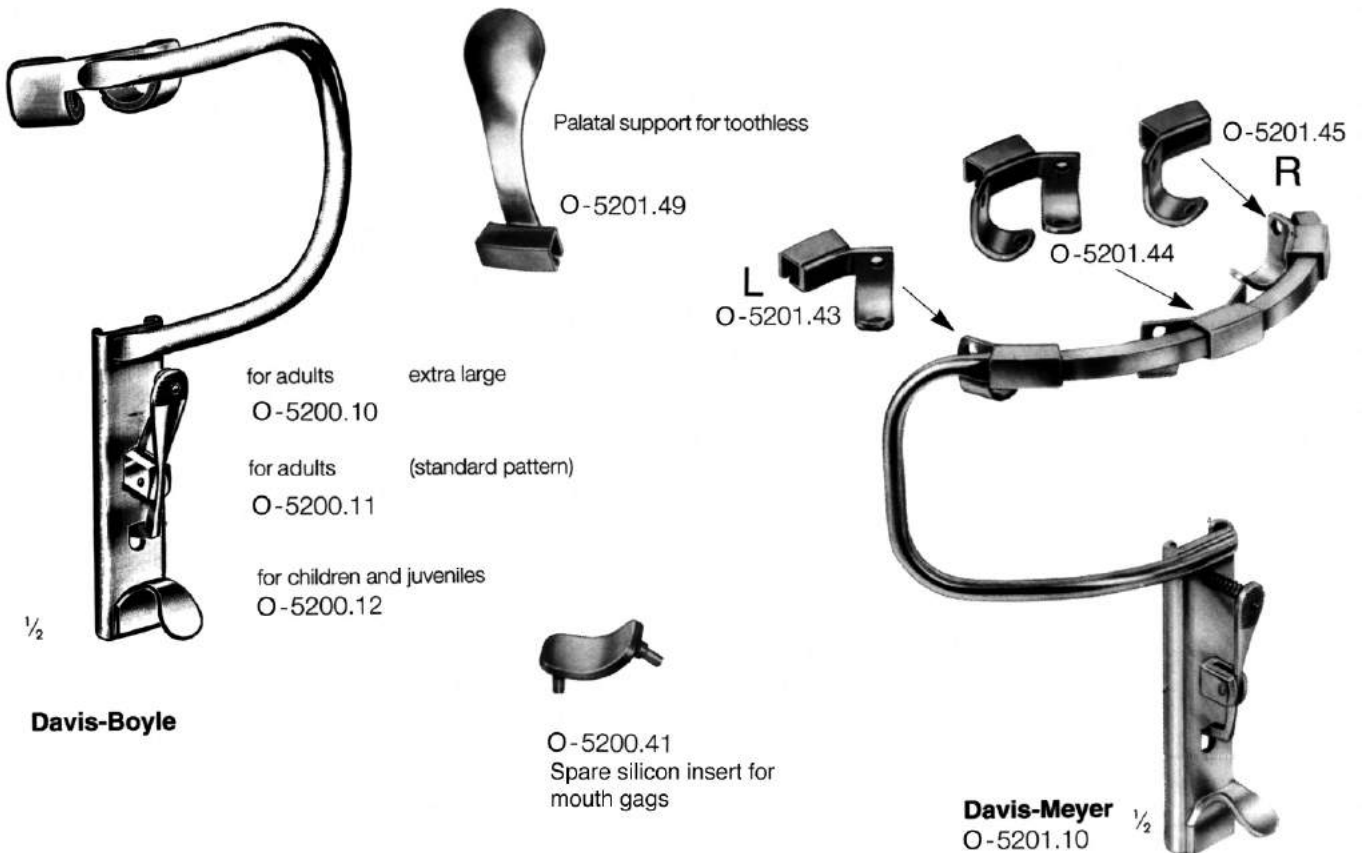

Davis-Boyle

for adults extra large
O-5200.10

for adults (standard pattern)
O-5200.11

for children and juveniles
O-5200.12

O-5200.41
Spare silicon insert for
mouth gags

Davis-Meyer
O-5201.10 1/2

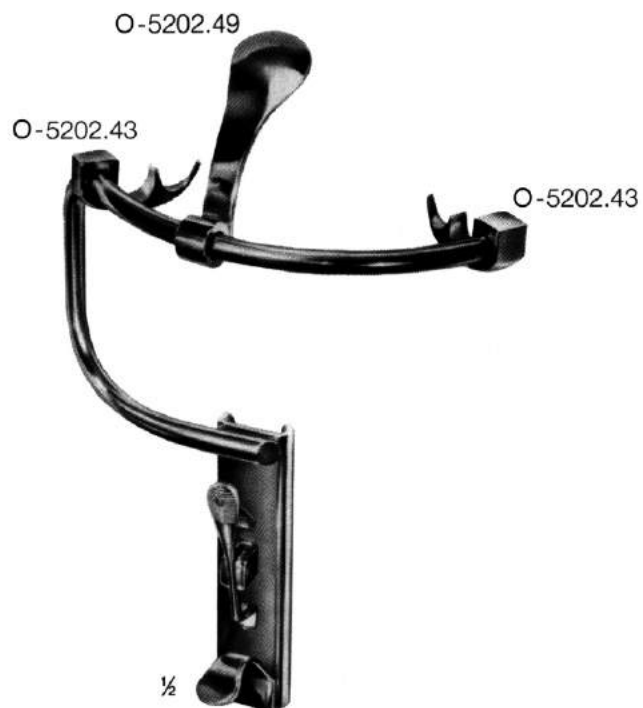

Kilner-Doughty
O-5202.10

Mclvor
O-5203.10



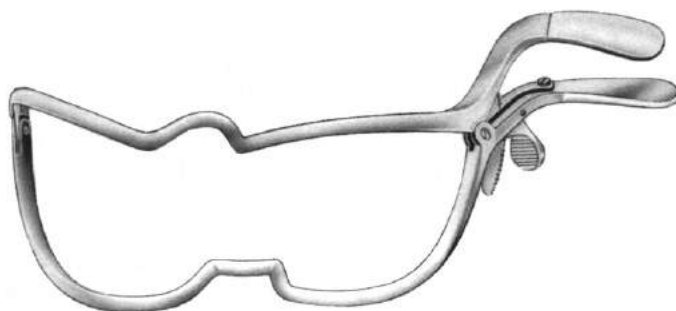

Jennings
 O-5510.09 9 cm/3 ½"
 O-5510.11 11 cm/4 ¼"
 O-5510.13 13 cm/5"
 O-5510.15 15 cm/6"

without tongue depressor

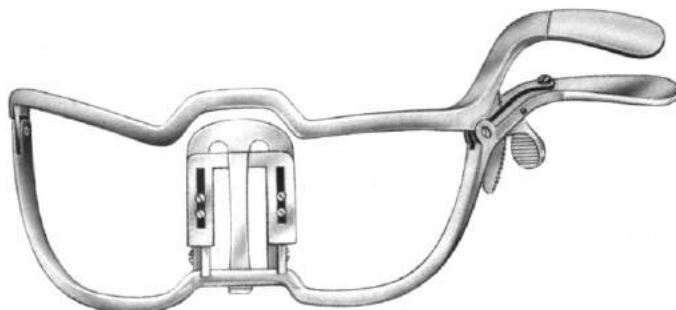

Jennings
 O-5511.09 9 cm/3 ½"
 O-5511.11 11 cm/4 ¼"
 O-5511.13 13 cm/5"
 O-5511.15 15 cm/6"

with tongue depressor

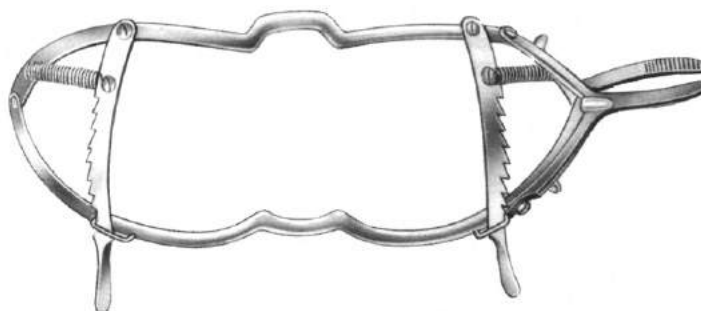

Whitehead
 O-5520.09 9 cm/3 ½"
 O-5520.11 11 cm/4 ¼"
 O-5520.13 13 cm/5"
 O-5520.15 15 cm/6"

without tongue depressor

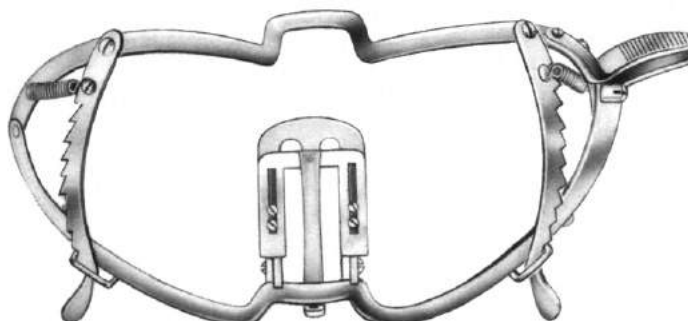

Whitehead
 O-5521.09 9 cm/3 ½"
 O-5521.11 11 cm/4 ¼"
 O-5521.13 13 cm/5"
 O-5521.15 15 cm/6"

with tongue depressor



- O-5530.09 9 cm/3 1/2"
- O-5530.11 11 cm/4 1/4"
- O-5530.13 13 cm/5"
- O-5530.15 15 cm/6"

without tongue depressor



Seemann-Seiffert

- O-5540.09 9 cm/3 1/2"
- O-5540.11 11 cm/4 1/4"
- O-5540.13 13 cm/5"

without tongue depressor

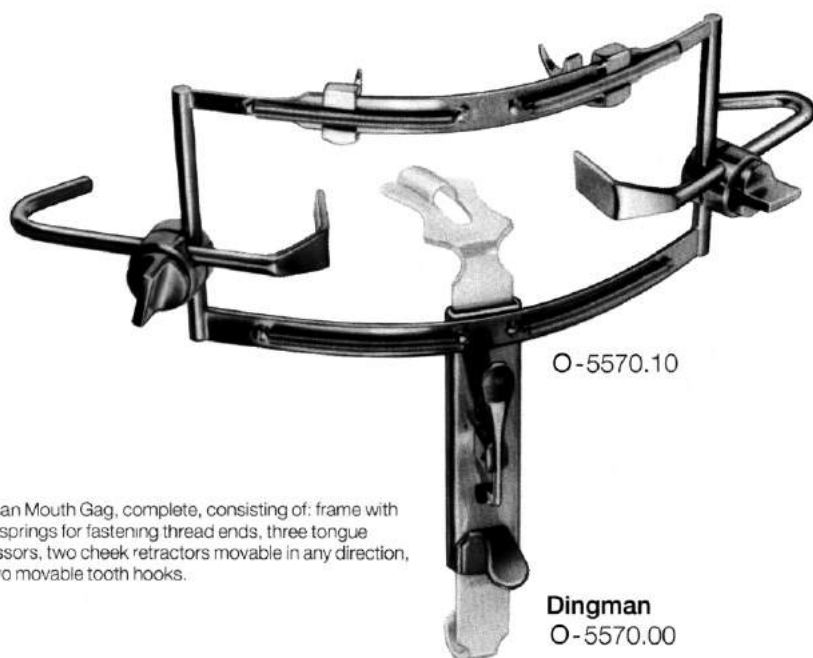

O-5570.10

Dingman
O-5570.00

Dingman Mouth Gag, complete, consisting of: frame with coiled springs for fastening thread ends, three tongue depressors, two cheek retractors movable in any direction, and two movable tooth hooks.

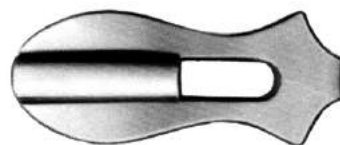

31 x 75 mm
O-5570.03



28 x 65 mm
O-5570-02



24 x 62 mm
O-5570-01

Laryngoscopes and Accessories

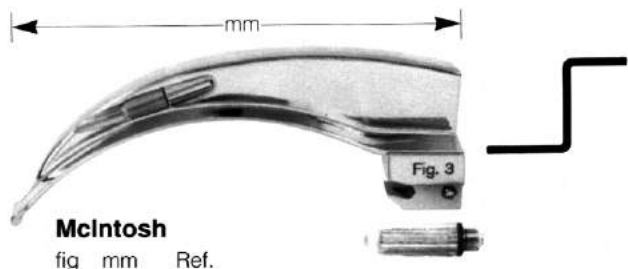

McIntosh

fig	mm	Ref.
0	75	O-6110.75
1	90	O-6110.90
2	110	O-6111.10
3	130	O-6111.30
4	150	O-6111.50

O-6107.10
O-6107.11

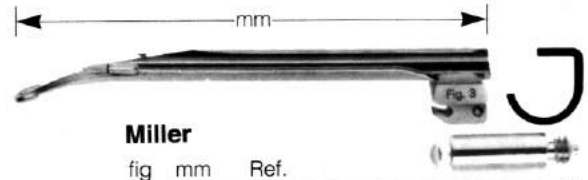

Miller

fig	mm	Ref.
0	75	O-6210.75
1	100	O-6211.00
2	155	O-6211.55
3	195	O-6211.95
4	205	O-6212.05

O-6107.10
O-6107.11



O-6130.02
Set consisting of:

- 1 x O-6101.30
- 2 x O-6107.11
- 1 x O-6110.90
- 1 x O-6111.10
- 1 x O-6111.30
- 1 x O-6100.30

McIntosh
O-6130.02
McIntosh KL
O-7130.02



O-6250.02
Set consisting of:

- 1 x O-6101.30
- 1 x O-6107.10
- 1 x O-6107.11
- 1 x O-6210.75
- 1 x O-6211.00
- 1 x O-6211.55
- 1 x O-6211.95
- 1 x O-6212.05
- 1 x O-6100.50

Miller
O-6250.02
Miller KL
O-7250.02

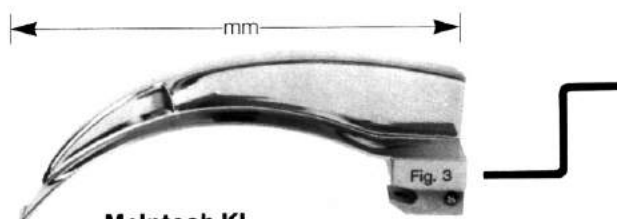

McIntosh KL

fig	mm	Ref.
0	75	O-7110.75
1	90	O-7110.90
2	110	O-7111.10
3	130	O-7111.30
4	150	O-7111.50

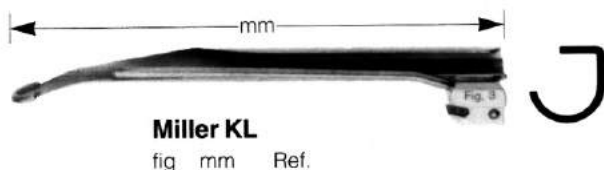

Miller KL

fig	mm	Ref.
0	75	O-7210.75
1	100	O-7211.00
2	155	O-7211.55
3	195	O-7211.95
4	205	O-7212.05

- O-7130.02**
Set consisting of:
- 1 x O-7101.32
 - 1 x O-7107.10
 - 1 x O-7110.90
 - 1 x O-7111.10
 - 1 x O-7111.30
 - 1 x O-6100.30

- O-7250.02**
Set consisting of:
- 1 x O-7101.32
 - 1 x O-7107.10
 - 1 x O-7210.75
 - 1 x O-7211.00
 - 1 x O-7211.55
 - 1 x O-7211.95
 - 1 x O-7212.05
 - 1 x O-6100.50



Battery Handles for Fiber Light Laryngoscopes



Alphabetical Index

	Page		Page
A			
Abdominal spatulas	333	Arruga needle holder	390
Abel tenaculum forceps	181	Arthur splinter forceps	75
Abraham tonsil knives	21	Asch septum forceps	532
Adlerkreuz grasping forceps	67	Aufricht (Walter) nasal hook	282
Adson-Baby (Cone) retractor	313	Aufricht	
Adson-Brown forceps	70, 392	... raspatory	472
Adson		... plastic scissors	251
... cranial rongeurs	513	Austin ear knives	562
... tissue forceps	62	Autopsy knives	26
... dressing forceps	59	Auvarad vaginal specula	414
... dura hook	271	Awl (Obwegeser)	544
... TC forceps	392	Ayre cone knives	11
... laminectomy retractors	315, 317, 318	B	
... needle holder	217	Babcock intestinal forceps	157
... nerve hook	276	Babinsky percussion hammer	599
... periosteal elevators	474	Baby-Adson dissecting forceps	106
... suction tube	38	Baby-Allis intestinal forceps	155
... forceps	89	Baby-Collin retractor	338
Agnew paracentesis needles	15	Baby-Crile forceps	92
Alan-Parks anal spreaders	354	Baby-Doyen intestinal clamp	147, 148
Alderdyce dissector	482	Baby-Haight rib spreaders	359
Alexander-Farabeuf raspatories	479	Baby-Inge lamina spreaders	320
Alexander		Baby-Mixer dissecting forceps	105
... biopsy forceps	422	Baby-Overholt dissecting forceps	106
... Chisels	455	Baby-Satinsky Vena cava clamps	113
... Gouges	455	Baby-Yankauer suction tubes	36
... tonsil needle	210	Backhaus towel forceps	189
Allis-Adair intestinal forceps	157	Bailey-Baby rib contractors	366
Allis-Coakley tonsil forceps	188	Bailey-Gibbon rib contractors	366
Allis		Bainbridge goitre clamp	93
... intestinal forceps	156	Bakes gall duct dilators	49
... tissue forceps	69	Balfour-Baby retractors	342
... tonsil forceps	188	Balfour abdominal retractors	342, 343
Alligator forceps	566	Ballenger-Hajek elevators	481
Allison lung spatula	367	Ballenger	
Allport mastoid searcher	275	... cartilage knives	18
Amputating knives	9	... swivel knives	19
Anderson-Adson		... tonsil forceps	188
... laminectomy retractor	315	... chisels	462
Andrew-Pynchon suction tubes	36	Ballentine hysterectomy forceps	177
Apart finger reposition forceps	524	Bane-Hartmann dental rongeur	512
Antoli-Candela ear raspatory	563	Baron suction tube	40

Alphabetical Index

Page	Page
Barbara needle 560, 561	... cutting forceps 520
Barraquer razor blade holder 29	... bone rongeurs 514
Barrett tenaculum forceps 183	Bodenhammer (Sims)
Barth ear curette 550	... rectal specula 440
Baumgartner needle holders 218, 378	Bone curettes 465:470
Baxter pinchcock clamps 197	Bone files 471, 472
Bayer paracentesis needles 16	Bone holding forceps 524:530
Beacham amniotomes 437	Bone hooks 305
Beckmann-Adson retractors 319	Bone levers 538:542
Beckmann-Barnhill curette 582	Bonney tissue forceps 68
Beckmann-Eaton retractors 318	Bose trachea hooks 272
Beckmann	Boynton needle holders 390
... nasal specula 572	Boys-Allis intestinal forceps 157
... retractor 318	Bozemann-Douglas
Beebee scissor 242	... dressing forceps 195
Bengolea hemostatic forceps 91	Bozemann-Finochietto
Benique catheter guides 449	... needle holder 379
Bennett tibia retractors 539	Bozemann-Fritsch catheter 426
Benson pylorus spreader 145	Bozemann
Bergmann	... needle holders 373
... bandage scissors 244	... suture hooks 217
... hooks 274	... dressing forceps 195
... mallet 451	Brand tendon grasping forceps 196
Bellucci ear scissor 570	Braun-Stadler
Berliner percussion hammers 599	... episiotomy scissor 238
Berry wire twistors 397	Braun
Best colon clamp 170	... uterine depressors 419
Bethune rib shears 522	... vaginal specula 416
Beyer	Breisky
... bone rongeur 513, 514	... pelvimeters 433
... mastoid punches 578	... vaginal specula 415
Billeau ear loop 550	Bridge dissecting forceps 102
Bircher-Ganske cartilage forceps 523	Brom lid retractor 284
Bircher meniscotomes 23	Brophy forceps 59, 63
Birkett hemostatic forceps 90	Brophy (Sullivan)
Blake (Zweifel) uterine curette 429	... dissecting scissors 231
Blake gall stone forceps 168	Brown
Blohmke tonsil seizing forceps 188	... plastic scissors 251
Blount knee retractors 306	... grasping forceps 70
Blumenthal dental rongeur 512	... tenaculum forceps 185
Boerma obstetrical forceps 434	Bruenings
Bottcher tonsil scissors 256	... septum knives 19
Bohler	... tonsil knives 21

Alphabetical Index

Page	Page
... tongue depressor 587	Cheatle sterilizer forceps 198
Bruhl plastic knives 14	Cheron uterine dressing forceps 192
Brunetti spinal chisels 464	Cherry-Raney
Brunner	... laminectomy retractor 324
... ligature conductors 213, 214	Child sterilizer forceps 198
... needles 207	Childe approximation forceps 71
... retractors 299, 300	Citelli mastoid punche 578
... rib shears 521	Claus-Eicken tonsil needles 211
Bruns	Claus cleft palate needles 209
... bandage scissors 246	Clothing scissors 243
... bone curettes 465, 467	Cloward-Hoen lamin.spreader 323
Brunings	Cloward
... ear specula 548	... dura hooks 276
... septum forceps 581	... fine hook 270
Buck	... Type Rongeur 497
... ear curette 551	... vertebrae spreader 322
... ear knives 14	Coakley
... foreign body lever 555	... antrum trocars 45
... percussion hammer 599	... curette 558
Buck-Wullstein Micro ear curette 557	Cobb
Buchwald tongue depressor 587	... Raspatories 483
Buelau empyema trocars 46	... spinal gouges 461
Burford-Finochietto rib spreader 361	Collin-Duval intestinal forceps 70, 158
Busch umbilical scissors 240	Collin-Hartmann retractor 301
Butler raspatory 472	Collin-Locktite retractors 340
<hr style="border-top: 3px double #000;"/> C <hr style="border-top: 3px double #000;"/>	Collin-Pozzi vulsellum forceps 182
Canfield tonsil knives 21	Collin
Caplan nasal scissors 254	... retractors 304, 339
Carpenter dissector 590	... clip removing forceps 219
Carroll osteotome 462	... Mallets 450
Carter elevator and curette 477	... scalpels 2
Cartilage knives 10	... tongue forceps 162
Carton catheter 426	... umbilical cord clamp 437
Castaneda sternotomy spreaders 356	... uterine dressing forceps 192
Castroviejo	... uterine elevating forceps 179
... needle holder 390	... vaginal specula 412
... razor blade holder 29, 30	Collyer pelvimeters 433
... scissor 269	Contour scalp retractor 322
Caspar self retaining retractor 328, 329	Converse nasal plastic knives 17
Catlin amputating knives 9	Cooley-Beck vascular clamps 139
Chadwick dental gum scissors 257	Cooley-Derra anastomosis forceps 137
Chaput forceps 156	Cooley
Charriere amputating saws 537	... renal artery forceps 165

Alphabetical Index

Page	Page
... atrial retractors	369
... coarctation forceps	140 ,141
... multi purpose forceps	139
... vascular forceps	65
... suction tube	37
... pediatric anastomosis forceps	136 ,137
... rib spreaders	363, 364
... sternotomy spreaders	358 ,365
... valve dilators	370
Cooper ligature needles	206
Cope trachea hooks	273
Coronary scissors	259
Corwin tonsil hemostat	589
Corwin-Hegar wire twistors	398
Coryllos-Bethune rib shears	522
Coryllos lung retractor	308
Cottle-Kazanjan	
... nasal cutting forceps	519
Cottle-Neivert hooks	282
Cottle-Walsham forceps	532
Cottle	
... Septum elevator	477
... septum raspatories	472
... columella forceps	76
... dorsal scissors	253
... hooks for posterior Nares	282
... mallet	450
... nasal specula	574
... rhinoplastic osteotomes	462
... rhinoplastic knives	17,18
... tenaculum hooks	272
Cotton applicator forceps	35
Crafoord(Coller)	
... dissecting forceps	90
Crafoord-Sellors	
... dissecting forceps	112
Crafoord thoracic scissors	235
Crile-Wood needle holders	218 ,381
Crile	
... forceps	92
... nerve hook	271
... retractors	281
Craig ethmoid forceps	581
Craig-Domnick ethmoid forceps	581
Cusco vaginal specula	410
Cushing-Kocher vein retractor	284
Cushing	
... dressing forceps	59
... forceps	393
... fine hook	270
... nerve hook	271
... raspatory	473
... skin hooks	371
... tissue forceps	62
... vein retractor	284 ,285
Cuzzi placenta scoops	435
Czerny	
... gall stone forceps	170
... rectal specula	440
... tenaculum forceps	185
<div style="display: flex; justify-content: center; align-items: center;"> <div style="width: 100px; border-bottom: 3px double #000; margin-right: 10px;"></div> D <div style="width: 100px; border-bottom: 3px double #000; margin-left: 10px;"></div> </div>	
Dale vascular forceps	123
Dandy	
... forceps	89
... nerve hooks	276
... trigeminal scissors	264
Dardik multi purpose forceps	142
Dartigues uterine forceps	179
Daubenspeck bone curettes	468
Davidson scapula retractors	367
Davis-Boyle mouth gags	603 ,605
Davis-Mayer mouth gags	605
Davis	
... dura dissector	484
... sterilizer forceps	73
...Grasping forceps	68
Day	
... ear hooks	275
... tonsil knives	21
De la Roza needles	208
Dean	
... tonsil knives	21
... tonsil scissors	255
Deaver	
... retractor	309 ,310

Alphabetical Index

Page	Page
... scissors	223
DeBakey-Bahnson aortic clamp	120
DeBakey-Bainbridge forceps	103
DeBakey-Beck aortic forceps	134
DeBakey-Castaneda	
... vascular clamps	131 ,132
DeBakey-Derra	
... anastomosis forceps	133
DeBakey-Diethrich	
... micro-bulldog clamps	80
... vascular forceps	64
DeBakey-Glover	
... anastomosis forceps	114
DeBakey-Kelly forceps	103
DeBakey-Morris aortic forceps	116
DeBakey-Mosquito forceps	103
DeBakey-Pean forceps	104
DeBakey-Rankin forceps	103
DeBakey-Reynolds	
... anastomosis forceps	134
DeBakey-Rumel thoracic forceps	112
DeBakey-Satinsky	
... Bulldog clamps	85
... Vascular clamps	130
DeBakey-Semb ligature carrier	128
DeBakey	
... vascular clamp	122 :136
... aortic forceps	116, 117
... bulldog clamps	81
... renal artery forceps	165
... vascular forceps	64 ,65
... aortic aneurism clamps	119
... bulldog clamps	82
... Carotid Bulldog clamps	85
... coarctation forceps	136
... TC forceps	394
... ligature forceps	128
... multi purpose forceps	127 ,135
... needle holders	382
... patent ductus forceps	136
... anastomosis forceps	134
... peripheral vascular clamp	122:124
... rib spreaders	361
... tangential occlusion clamps	130
... vascular dilators	48
... vascular scissors	260 ,262 ,409
DeBoer rib spreaders	360
Dejerine percussion hammers	599
De LEE obstetrical forceps	434
DeMartel (Bailey) wire conductors	533
DeMartel (Willet) forceps	161 ,180
DeMartel forceps	161
Demel wire guides	545
Denhart mouth gags	603
Denis browne forceps	68
DePalma menisectomy knives	23
Derf needle holder	218 ,378
Deschamps needles	200: 205,207
Desjardins	
... gall duct forceps	168
... gall stone forceps	169
... gall stone probes	447
... gall stone scoops	447
Desmarres lid retractor	284
Dieffenbach	
... bulldog clamps	78
... operating knives	3
Diener Ferrozell mallets	453
Diethrich	
... aortic forceps	115
... micro-bulldog clamps	79
... vascular scissors	263
Dingman	
... bone holding forceps	524
... mouth gags	608
... Zygoma elevators	486
Dittel urethral dilators	50
Dixon-Lovelace forceps	94
Douglas antrum trocars	45
Downing cartilage knives	23
Doyen-Stille retractors	334
Doyen-Jansen mouth gags	603
Doyen	
... abdominal retractors	335 ,338
... abdominal scissors	235
... grooved directors	32

Alphabetical Index

Page	Page
... intestinal clamp	147, 148
... mallets	451
... rib raspatories	479
... towel clamps	188
... myoma screws	419
... vaginal retractors	348, 417
Dubois cephalotomy scissors	237
Duehrssen	
... dressing forceps	58
... tissue forceps	61
Duplay tenaculum forceps	182
Dupuy-Weiss tonsil needles	211
Durante lung grasping forceps	69
Durham cleft palate needle	210
Duval tissue forceps	70
<hr style="border: 1px solid black;"/> E <hr style="border: 1px solid black;"/>	
Ear syringe	552
Echlin (Duckbill) bone rongeur	518
Eder cotton applicator	35
Eicken	
... canulas	41
... ligature catcher	211
Eiselsberg stitch scissors	268
Elliot obstetrical forceps	434
Emmet	
... fistula hooks	274
... polypus forceps	194
Endarteriectomy strippers	47
Engel plaster saws	534
Eppendorfer biopsy forceps	423, 424
Epstein bone curettes	466
Esmarch	
... bandage scissors	244
... plaster knives	25
Eufrate-Pasque needle holder	387
Evans forceps	393
<hr style="border: 1px solid black;"/> F <hr style="border: 1px solid black;"/>	
Fager dura dissectors	485
Falk tonsil needles	211
Fansler-Ives anoscopes	442
Farabeuf-Collin raspatories	473
Farabeuf-Lambotte	
... bone holding forceps	529
Farabeuf	
... bone holding forceps	529
... Periosteal raspatories	473
... retractors	303
Farrell cotton applicator	33
Faulkner ethmoid curette	558
Faure	
... biopsy forceps	421
... peritoneal forceps	176
Favaloro-Morse	
... sternotomy spreader	357
Favoloro vascular scissors	259
Featherlight bulldog clamps	78
Feilchenfeld splinter forceps	74
Fein cotton applicator	34
Female catheters	43
Fergusson	
... bone holding forceps	525
... haemorrhoidal forceps	161
... suction tube	38
Ferris-Smith tissue forceps	68
Ferris Smith Rongeur	496
Ferrozell ligature conductor	215
Finger ring saw	547
Fleurant trocars	44
Finochietto-Baby-Haight	
... rib spreaders	360, 365
Finochietto-Baby rib spreaders	359
Finochietto-Infant rib spreaders	365
Finocchietto	
... Forceps	144
... needle holders	217, 380
... rib spreaders	359, 363
... thoracic scissors	235
Fisch crura nippers	564, 565
Fish (Theobald) sinus probe	31
Fisher tonsil knives	21
Flat nose pliers	397, 532
Fomon	
... chisels	462, 475
... hooks for posterior nares	282

Alphabetical Index

Page	Page
... nasal plastic knives	17
... Bone file	400
... scissors	252, 253
Foerster dressing forceps	193
Fox dermal curettes	470
Frankfeld rectal snares	446
Frankfeldt cotton applicator	35
Frazier	
... dura hooks	271, 276
... dura separators	486
... suction tubes	38
Freer	
... elevator	482
... mucosa hooks	272
... mucosa knives	18
... septum elevators	476
... septum gouge	463
... septum knives	19
... periosteotome	463
... chisel	463
French Eye (Ryder) needle holder	383
French tuning fork	601
Frenzel tongue depressor	587
Friedman dental bone rongeur	512
Friedrich ligature carrier	217
Friesner ear knives	15
Fritsch abdominal retractors	334
Fryholm bone rongeur	518
Fulton laminectomy rongeur	515
G	
Garrett vascular dilators	48
Gast tongue depressors	604
Gellhorn biopsy forceps	421
Gelpi vaginal retractors	350
Gemini-Mini (Mixer)	
... dissecting forceps	111
Gerald	
... dressing forceps	59
... tissue forceps	62
Gerster traction bar	531
Gerzog-Sexton Tympanum knife	15
Gerzog mallet	451
Giannini needle holders	391
Gigli handle & wire saws	533
Gil-Vernet renal sinus retractor	351
Gillies	
... dressing forceps	59
... needle holders	217, 385
... skin hooks	273
... tissue forceps	62
... Zygoma elevators	486
Glover	
... bulldog clamps	84, 85
... coarctation forceps	121
... patent ductus forceps	121
Gluck rib shears	521
Goelet retractors	301
Goldman-Fox scissors	258, 408
Gomco Circumcision instrument	449
Gomel knotting forceps	72
Good tonsil scissors	255
Gorney face lifting scissors	249
Gosset abdominal retractors	341
Gourdet uterine curette	429
Graefe	
... skin hooks	371
... eye forceps	77
... skin hook	274
... fixation forceps	66
... iris hooks	274
Graham dura hooks	276
Graves vaginal specula	411
Gray cystic duct forceps	168
Grazil scissor	222
Green-Armytage uterine forceps	180
Green	
... cystic duct forceps	168
... fixation forceps	66
... thyroid gland retractors	306
Gregory	
... bulldog clamps	83
... profunda clamps	129
Groenholm lid retractor	284
Grooved directors	32
Gross	

Alphabetical Index

Page	Page
... nasal plastic knives	17
... Bone file	400
... scissors	252, 253
Foerster dressing forceps	193
Fox dermal curettes	470
Frankfeld rectal snares	446
Frankfeldt cotton applicator	35
Frazier	
... dura hooks	271, 276
... dura separators	486
... suction tubes	38
Freer	
... elevator	482
... mucosa hooks	272
... mucosa knives	18
... septum elevators	476
... septum gouge	463
... septum knives	19
... periosteotome	463
... chisel	463
French Eye (Ryder) needle holder	383
French tuning fork	601
Frenzel tongue depressor	587
Friedman dental bone rongeur	512
Friedrich ligature carrier	217
Friesner ear knives	15
Fritsch abdominal retractors	334
Fryholm bone rongeur	518
Fulton laminectomy rongeur	515
<div style="display: flex; align-items: center; justify-content: center;"> <div style="width: 100px; border-bottom: 3px double #000; margin-right: 10px;"></div> <div style="font-size: 2em; font-weight: bold; margin: 0 10px;">G</div> <div style="width: 100px; border-bottom: 3px double #000; margin-left: 10px;"></div> </div>	
Garrett vascular dilators	48
Gast tongue depressors	604
Gellhorn biopsy forceps	421
Gelpi vaginal retractors	350
Gemini-Mini (Mixer)	
... dissecting forceps	111
Gerald	
... dressing forceps	59
... tissue forceps	62
Gerster traction bar	531
Gerzog-Sexton Tympanum knife	15
Gerzog mallet	451
Giannini needle holders	391
Gigli handle & wire saws	533
Gil-Vernet renal sinus retractor	351
Gillies	
... dressing forceps	59
... needle holders	217, 385
... skin hooks	273
... tissue forceps	62
... Zygoma elevators	486
Glover	
... bulldog clamps	84, 85
... coarctation forceps	121
... patent ductus forceps	121
Gluck rib shears	521
Goelet retractors	301
Goldman-Fox scissors	258, 408
Gomco Circumcision instrument	449
Gomel knotting forceps	72
Good tonsil scissors	255
Gorney face lifting scissors	249
Gosset abdominal retractors	341
Gourdet uterine curette	429
Graefe	
... skin hooks	371
... eye forceps	77
... skin hook	274
... fixation forceps	66
... iris hooks	274
Graham dura hooks	276
Graves vaginal specula	411
Gray cystic duct forceps	168
Grazil scissor	222
Green-Armytage uterine forceps	180
Green	
... cystic duct forceps	168
... fixation forceps	66
... thyroid gland retractors	306
Gregory	
... bulldog clamps	83
... profunda clamps	129
Groenholm lid retractor	284
Grooved directors	32
Gross	

Alphabetical Index

Page	Page
... polypus forceps	191
... foreign body instruments	550
Gross-Maier polypus forceps	191
Guillen suction raspatories	42
Guthrie fixation hooks	274, 371
Guy hemostatic forceps	162
Guyon	
... catheter guides	449
... kidney pedicle clamp	164
... urethral dilators	50, 51
<hr style="border: 1px solid black;"/> <b style="font-size: 2em; font-weight: bold;">H <hr style="border: 1px solid black;"/>	
Haberer abdominal spatulas	333
Haglund-Stille plaster spreaders	535
Hajek-Kofler	
... Rongeur	509
... nasal cutting forceps	579
Hajek mallet	450
Halle	
... bone curettes	469
... dissector	482
... dura knives	20
Halsted-Mosquito forceps	88
Hank urethral dilators	51
Harken (Nissen) rib spreaders	362
Harken auricle Clamp	113
Harrington splanchnic retractor	307
Harrison Knife	562
Haslinger velum retractor	591
Hartmann	
... antrum wash canulas	41
... cotton applicator	34
... ear hooks	273
... ear specula	549
... polypus forceps	555, 556, 580
... eustachian catheters	42
... Forceps	87
... nasal specula	572
... tuning forks	601
... tongue depressor	586
... tonsil forceps	589, 592
Hartmann-Halle nasal specula	572
Hartmann-Hoffmann ear forceps	556
Hartmann-Noyes ear forceps	556
Hartmann-Wullstein ear forceps	556
Hartmann/Wiener nasal specula	571
Harvey wire cutting scissors	242
Hauser-Cooley rib spreaders	360
Hayes rectum clamp	160
Heaney-Ballentine	
... hysterectomy forceps	177
Heaney-Kanter	
... hysterectomy forceps	177
Heaney-Rezek	
... hysterectomy forceps	177
Heaney	
... hysterectomy forceps	176
... needle holders	380
Heath suture scissors	268
Hegar	
... needle holders	373
... uterine dilators	52, 53
Heiss forceps	90
Heister mouth gags	603
Helferich-Bier amputating saw	537
Henke dissector	590
Henly self retaining retractor	316
Hennig plaster spreaders	535
Hepp-Scheidel needle holder	391
Herrick kidney pedicle clamp	163
Herzfeld vein retractor	284
Heifetz brain spatula	57
Hess nerve root retractors	277
Hessberg needles	208
Hetzer valve dilators	369
Heymann nasal scissors	252
Heywood-Smith uterine forceps	178
Hibbs-Spratt spinal curettes	466
Hibbs	
... gouges	459
... Chisels, Osteotome	459
... toothed blades for spreaders	327
Hirschmann anoscopes	442
Hoen	
... dura hooks	276
... dura separators	486

Alphabetical Index

Page	Page
Hoffmann	
... grasping Forceps	498
... pinchcock clamps	197
Hohmann bone levers	540:542
Holmgren ear specula	557
Holsher nerve root retractor	277
Holzbach hemostatic forceps	171
Hopkins plaster knives	25
Horsley dura separators	486
Hosel	
... needle holders	375
... retractors	297
House	
... ear curette	559
... Knife	562
... forceps	187
... retractors	281
House-Dieter malleus nipper	564
House(Guilford-Wright) elevator	563
House-Luer Suction tubes	39
Howarth septum raspatories	477
Hough ear raspatory	563
Hulka tenaculum forceps	181
Humby dermatome	13
Hunter splinter forceps	74
Hurd	
... tonsil needles	209
... dissector	590
Hylin raspatories	474
I	
Incision scissors	223
Inge lamina spreaders	320, 321
Interosseous knives	9
Intervertebral Disc Rongeur	488:490
Intracardiac needle holders	384
Iowa	
... membrane puncturing forceps	183
... trumpet needle guide	437
Iris scissors	223, 267, 408
Israel rake retractors	290
Itard suction tube	42
Iterson trachea hooks	272
J	
Jackson	
... chest supports	606
... Rongeur	494
... trachea hooks	272, 273
Jacobi needles	208
Jacobs vulsellum forceps	183
Jacobson	
... curettes	470
... ear knives	14
Jamison dissecting scissor	230
Jansen	
... bone rongeurs	513
... curettes	470
... ear and nasal forceps	76
... raspatory	475
... self retaining retractor	314
Jatho naso-pharyngeal forceps	592
Jansen-Middleton septum forceps	577
Jansen-Newhart mastoid probe	550
Jennings mouth gags	607
Jobson-Horne cotton applicator	34
Johns-Hopkins	
... applying forceps	80
... bulldog clamps	78
... dissecting forceps	107
Joker elevator	482
Joll vaginal retractor	351
Jones towel clamps	189
Joseph-Masing septum raspatory	477
Joseph	
... fistula scissors	247
... mucous hooks	278
... nasal saw	582
... raspatories	472, 475
... rhinoplastic knives	17
Judd-Allis intestinal forceps	157
Judd-Masson bladder retractor	355
K	
Kabierske powder blower	553
Kader abdominal spatulas	331
Kahn face lifting scissors	250

Alphabetical Index

Page	Page
Lahey	
... gall duct forceps	107
... goitre retractor	292
... goitre seizing forceps	185
... skin hooks	278
Lambert-Kay aortic forceps	117
La force adenotomes	584, 585
Lambotte	
... bone holding forceps	529
... osteotomes	457
... raspatories	473
Landau vaginal retractors	417
Landolt enucleation scissor	266
Lane	
... bone holding forceps	530
... bone screw drivers	543
... stomach clamp	155
... tissue forceps	61
... towel forceps	189
Lange-Hohmann bone levers	541
Lange-Wilde ear snare	554, 583
Lange hooks	282
Langenbeck	
... Amputating knives	9
... cartilage knife	10
... bone holding forceps	525
... ear curette	550
... elevators	480, 481
... metacarpal saw	546
... needle holders	375
... periosteal raspatories	473
... resection knives	10
... retractors	291, 292, 306
Larsen grasping forceps	73
Laryngeal mirrors	595
Laryngeal suction tubes	42
Lawrence dissecting forceps	102
Lead hands	546
Lebsche	
... Sternum chisels	464
... Sternum shear	521
... wire saw conductors	533
Lees bronchus clamps	126
Legueu bladder retractors	353, 355
Leksell bone rongeurs	517
Leland-Jones vascular forceps	124
Lemmon	
... needle holders	382
... sternal approximator	366
Lempert	
... bone rongeurs	513
... elevators	476, 481
... endaural bone curette	469
... excavators	476
Lerche grasping forceps	67
Leriche	
... abdominal spatulas	332
... hemostatic forceps	89
Lewin bone holding forceps	524
Leyla retractor system	330
Lexer-Baby scissors	229
Lexer-fino scissors	228
Lexer	
... gouges	456
... osteotomes	456
Lichtenberg-Ryder	
... needle holders	376
Lichtenberg needle holders	376
Lichtwitz trocars	45
Liddle aortic forceps	115
Liebermann applicators	33
Lister	
... bandage scissors	244
... sinus forceps	190
Liston-Key-Horsley	
... bone cutting forceps	520
Liston	
... amputating knives	9
... bone cutting forceps	519
Littauer-Liston	
... bone cutting forceps	519
Littauer stitch scissor	268
Little retractors	292
Littler plastic scissors	251
Littlewood forceps	159
Locklin dental gum scissors	257

Alphabetical Index

Page	Page
Lockwood-Allis intestinal forceps 156	... cartilage forceps 523
Lockwood intestinal forceps 158	... nerve root retractor 277
Lorna towel forceps 189	... pelvimeters 433
Love	... vaginal retractors 347
... nerve root retractors 277	Martini curettes 470
... uvula retractor 591	Masing
Lovelace forceps 158	... graduated elevators 477
Lower cystic duct forceps 168	... slitting knives 18
Lowman bone clamps 531	... columella forceps 76
Lucae	Mass. Gen. Hosp. elevators 480
... ear dressing forceps 76, 393	Masson-Luthy needle holder 379
... ear hooks 275	Mathieu-Berry wire twisters 397
... paracentesis needles 16	Mathieu-Grazil needle holder 376
... tuning forks 601	Mathieu-Stille needle holder 376
Luc ethmoid forceps 581	Mathieu
Lueneburg elevators 481	... foreign body forceps 449
Luer-Korte gall stone scoops 448	... needle holders 218, 374
Luer	... rectal specula 441
... bone rongeurs 513, 514	... retractors 281, 304
... haemorrhoidal forceps 162	... vaginal retractors 416
... retractors 281	Matson rib strippers 479
Luikart-Bill	Mayfield bone rongeurs 516
... handle for obstetrical forceps 434	Mayo-Adams retractor 338
Luikart obstetrical forceps 434	Mayo-Blake gall stone forceps 169
Lukens retractor 273	Mayo-Collin retractor 304
Lung spatulas 367	Mayo-Harrington
Luniatschek packer 591	... thoracic scissors 226
Lurz haemorrhoidal ligator 445	Mayo-Hauberisser wire twisters 398
Luthy-Beck needle holder 375	Mayo-Hegar needle holder 217, 218, 379
<hr style="border: 1px solid black;"/> <b style="font-size: 2em; font-weight: bold;">M <hr style="border: 1px solid black;"/>	
MacQuigg-Mixer	Mayo-Lexer scissors 228, 403
... dissecting forceps 105	Mayo-Noble scissors 228
Magill forceps 199	Mayo-Robson intestinal clamp 146
Maltz	Mayo-Russian grasping forceps 68
... guarded knives 18	Mayo-Stille scissors 225, 403
... Rasps 399, 472	Mayo
Marbach episiotomy scissors 238	... common duct scoops 447
Markham-Meyerding	... cystic duct scoops 447
... vert. spreaders 322	... gall stone scoops 447, 448
Marquardt bone rongeurs 516	... tongue depressor 587
Martin	... scissors 224, 402
... Cartilage scissors 241	Maunder oral screw 587
	McDonald dissectors 482
	McGivney hemorrhoidal forceps 445

Alphabetical Index

Page	Page
McIndoe	
... bone cutting forceps	520
... cartilage scissors	241
... dressing forceps	59
... tissue forceps	62
McIntosh laryngoscope	609
McGee	
... needle	561
... Crimpers	565
McIvor mouth gags	604, 606
McKenty	
... septum raspatories	474
... raspatories	477
McKenzie	
... applying forceps	220
... bending/cutting forceps	220
... silver wire	220
Mead	
... bone rongeur	512
... mallet	451
Meeker dissecting forceps	102
Meltzer forceps	592
Mendler menisectomy knives	24
Menghini needles	46
Meniscotomy knives	23
Meriam forceps	393
Metzenbaum-fino scissors 233, 234, 404	
Metzenbaum	
... dissecting scissors	227, 232, 404, 406
... needle holders	217, 377
Meyerding	
... retractor	281, 301
... blades for spreaders	327
... vertebrae spreaders	322
Michel	
... clip applying forceps	71, 219
... suture clips	219
... rhinoscopic mirror	594
Micro-Mosquito forceps	87
Micro-Ryder needle holders	383
Micro Kerrison Rongeur	507
Micro needle holder	388, 389
Micro-Vascular needle holder	382
Micro ear forceps	567, 568
Micro ear scissors	569, 570
Middeldorpf retractor	296, 334
Mikulicz-Baby forceps	175
Mikulicz	
... abdominal retractors	336, 337
... peritoneal forceps	175
... tonsil forceps	188
Miller	
... bone files	399
... Laryngoscope	609
... skin retractors	270
Milligan d/e dura dissector	485
Millin	
... bladder retractors	355
... caspsule forceps	166
... ligature forceps	166
... prostatic forceps	166
Mills neuro. scissors	264
Mini-Friedman bone rongeur	512
Mini-Glover bulldog clamps	81
Mini-Lambotte osteotomes	457
Mini-Langenbeck retractors	283
Mini-Lexer gouges, osteotomes	456
Mini-Tischler biopsy forceps	423
Mixer	
... Dissecting forceps	105, 107
... gall stone forceps	170
... surgical scissors	223
Mixer-O'Shaughnessy forceps	105
Moberg retractors	283
Mod. Berlin biopsy curette	425
Mod. Bonn Iris Scissors	267
Mod. Klinikum Berlin tube clamp	197
Mod. USA	
... tissue forceps	61
... plaster spreader	535
... umbilical cord scissor	240
Modell USA dressing forceps	58
Modell Wien suture hook	217
Mohr pinchcock clamps	197
Mollison laminectomy retractor	315
Moncorps miliaria knives	55

Alphabetical Index

Page	Page
Moore gall stone scoop 448	Noto uterine polypus forceps 178
Morris retractor 293	Nott vaginal specula 411
Morse modif.	Novak biopsy curettes 425
... Sternotomy spreaders 357	Nusbaum intestinal clamp 154
Moritz-Schmidt tongue depressor 586	
Moynihan	O
... gall stone probe and scoop 447	O'Brien stitch scissors 268
... hemostatic forceps 168	O'conner fine hook 270, 371
Muck periosteal knives 14	O'Sullivan-O'Connor retractors 344, 349
Muller-Claus pin cutters 395	Ochsner
Munich Grasping Forceps 499	... aortic forceps 115
Murphy-Lane bone skid 539	... gall bladder trocars 44
Museux tenaculum forceps 184, 186	... gall duct probe 447
Myrtle leaf probes 31	... ligature carrier 71
	Olivecrona-Toennis
N	... clip applying forceps 220
Nabatoff vein stripper 47	Olivecrona (Crafoord) forceps 90
Naegele obstetrical forceps 433	Olivecrona
Nager	... bone rongeurs 514
... tonsil needles 209	... neuro scissors 265
... soft palate retractor 591	... trigeminal knives 20
Narath ligature needles 206	... brain spatula 56
Neff menisectomy knives 24	Ollier rake retractors 288
Negus	Olsen-Hegar needle holders 385
... chest supports 606	Ombredanne mallet 451
... mouth gags 605	Operating scissor 221
... suction dissector 39	Overholt dissecting forceps 109, 110
... tonsil forceps 187	
Neivert	P
... Hooks 282	Par-style needle holder 378
... needle holders 373	palmer nasal specula 571
Nelaton grooved directors 32	Parametrium
Nelson	... clamps 173
... forceps 69	... scissors 239, 407
... thoracic trocars 44	Parell needle holders 391
Neonatal clamps 131	Parker-Langenbeck (US Army)
Neurosurgical needle holder 384	... retractor 304
New Orleans needle holder 380	Parker-Mott retractors 303
News tracheotomy hooks 272	Parker retractors 303
Niro skin hooks 270	Partsch
Nissen gall duct forceps 168	... chisels 454
Northbent stitch scissors 268	... Gouges 454
Norwood rectal snares 446	... mallet 450

Alphabetical Index

Page	Page
Paul hooks	275
Payr-Baby intestinal forceps	438
Payr	
... intestinal forceps	439
... ligature conductors	216
Pean kidney pedicle clamp	163
Pean forceps	95
Peapod Rongeur	494
Pederson vaginal specula	411
Peers towel forceps	189
Peet splinter forceps	75
Pelkmann uterine forceps	190
Pelteson cotton applicator	34
Penfield dura dissectors	487
Pennington	
... forceps	158
... septum elevators	477
Percy retractors	536
Perkins endaural retractors	315
Perthes reamers	544
Pestalozza placenta curettes	435
Phaneuf forceps	171
Piccolo cotton applicator	33
Pierce	
... antrum trocars	45
... septum raspatories	477
Pin and wire cutter	395, 396
Pinard Stethoscopes	600
Piper obstetrical forceps	433
Plain rib shears	269
Plester	
... endaural retractor	314
... Knife	562
... needle	560
... suctin tube	40
Politzer	
... furuncle knives	14
... mastoid knives	14
.. ear bag	552
... ear specula	549
... paracentesis needles	15, 16
Poole suction tubes	36
Post-Mortem	
... hammer	450
... knives	27
Potts-DeMartel neuro. scissors	264
Potts-Nevins forceps	393
Potts-Smith (DeMartel)	
... vascular scissors	260
Potts-Smith	
... cartilage scissors	241
... dressing forceps	60, 392
... tissue forceps	63
... vascular scissors	262, 409
Pozzi tenaculum forceps	182
Pratt	
... tenaculum forceps	186
... forceps	161
... rectal specula	440
Presbyterian-Hospital	
... tubing clamps	197
Price-Thomas bronchus clamp	143
Prince tonsil scissor	256
Probes stainless, silver, with eye	31
Presbyterian-Hospital	
... tube forceps	197
Providence-Hospital forceps	89
Putti bone raspatory	471
<div style="display: flex; justify-content: center; align-items: center;"> <div style="width: 100px; border-bottom: 3px double #000; margin-right: 10px;"></div> <div style="font-size: 2em; font-weight: bold; margin: 0 10px;">Q</div> <div style="width: 100px; border-bottom: 3px double #000; margin-left: 10px;"></div> </div>	
Quervain elevators	480, 481
Quinby dental gum scissors	257
Quire foreign body lever	555
<div style="display: flex; justify-content: center; align-items: center;"> <div style="width: 100px; border-bottom: 3px double #000; margin-right: 10px;"></div> <div style="font-size: 2em; font-weight: bold; margin: 0 10px;">R</div> <div style="width: 100px; border-bottom: 3px double #000; margin-left: 10px;"></div> </div>	
Radolf nail extracting forceps	531
Ragnell-Davis retractors	281
Ralks splinter forceps	75
Rampley dressing forceps	194
Randall	
... biopsy curettes	425
... kidney stone forceps	167
Raney hemostasis clips	219
Rankin-Crile forceps	93
Rankin-Kelly forceps	92
Recamier-Bumm uterine curettes	436

Alphabetical Index

Page	Page
Recamier uterine curettes	430
Rees face lifting scissors	248
Rehn transplantation knives	11
Reiner plaster knives	25
Reverdin	
... abdominal spatulas	333
... needles	212
Reynolds dissecting scissors	230
Reichert epiglottis retractor	594
Ricard abdominal retractors	340
Richardson retractor	306
Richter-Heath	
... clip removing forceps	219
Richter Rongeur	510
Rienhoff-Finochietto rib spreader	360
Richnau-Holmgren ear specula	557
Ritter-halle frontal sinus bougies	32
Roberts dissecting forceps	101
Rochard abdominal retractors	346
Rochester-Carmalt forceps	94
Rochester-Ochsner forceps	98
Rochester-Pean forceps	96
Roder towel forceps	189
Roger septum raspatories	477
Rogge sterilizer forceps	198
Rollet eye hooks	275
Roos rib shears	522
Rose retractors	281
Roser Konig mouth gags	603
Rosen	
... ear elevator	563
... needle	560, 561
... Knife	562
... suction tube	40
Rotter cleft palate needle	210
Rottgen-Ruskin bone rongeurs	516
Roux-Magnus retractors	302
Roux retractors	302
Royce ear knives	16
Rudd haemorrhoidas ligator	445
Rumel - Belmont tourniquet	368
Rumel forceps	108
Ruskin-Liston bone cutting forceps	520
Ruskin bone rongeurs	516
Russian Modell grasping Forceps	68
Rust amputating saws	537
S	
Saalfeld comedo extractors	54
Sachs	
... dura dissectors	485
... trachea retractor	273
... dura hooks	276
... dura separators	484, 486
Saenger placenta forceps	180
Santulli bulldog clamp	83
Sanvenero fistula scissors	247
Sarot	
... hemostatic Forceps	100
... needle holders	382
Satinsky vascular scissors	261
Satterlee amputating saws	537
Sauerbruch	
... pick up forceps	198
... retractor	308
... rib cutting forceps	521
... rib shears	521
Sawtell tonsil forceps	187
Scalpel handles	4,5
Schamberg comedo extractors	54
Schaedel towel forceps	189
Schede bone curettes	465
Schiller bone curettes	469
Schindler peritoneal clamp	176
Schink dermatome	12
Schlesinger Grasping Forceps	499
Schmid irrig. cannulas	38
Schmieden	
... dura scissors	265
... ligature conductors	215
... ligature needles	206
Schneider raspatories	475
Schmidt tonsil forceps	187
Schoemaker-Loth stitch scissors	268
Schoenborn thyroid gland retractor	273
Schroeder	

Alphabetical Index

Page	Page
... uterine scoops	428
... vulsellum forceps	181, 184
Schubert biopsy forceps	420
Schuknecht	
... wire cutting scissor	242
... Crimpers	565
... Knives	562
Schultze salpingograph	427
Schumacher	
... biopsy forceps	420, 423
... umbilical scissors	240
Schwartz clip applying forceps	86
schmeden nasal forceps	576, 589
Scoville-Haverfield retractor	325
Scoville	
... nerve root retractor	277
... hemilaminectomy retractors	325, 327
... nerve root retractors	277
Scudder intestinal clamp	152, 153
Sebileau elevators	481
Sedillot periosteal elevator	475
Seemann-Seiffert mouth gags	608
Segond myoma knives	11
Seletz-Gelpi vaginal retractor	350
Sellheim obstetric lever	434
Sellers rib spreaders & contractors	366
Semb	
... bone cutting forceps	520
... bone holding forceps	525
... forceps	144
... rongeurs	517
... periosteal raspatories	479
Semken	
... dressing forceps	59
... TC Forceps	393
... tissue forceps	62
Semm vaginal specula	412
Senn-Green retractor	283
Senn-Miller retractors	281
Senning needle holder	377
Setter bone holding forceps	527
Seutin Clothing scissors	245
Sewall raspatories	474
Sexton	
... ear knives	16
... Tympanum knives	14
Seyffert vaginal specula	411
Shapleigh ear curette	550
Shambaugh needle	560
Shea ear curette	557
Sheehan osteotome	462
Shortbent stitch scissors	268
Siebenmann suction tube	41
Siebold scissors	237
Siegle ear specula	548
Silver dermatome	12
Simon	
... bone curettes	468
... fistula hooks	274
... fistula knives	8
... vaginal retractor	347
Simpson-Braun obstetrical forceps	434
Simpson-Luikart obstetrical forceps	434
Simpson obstetrical forceps	433
Sims-Maier polypus forceps	192
Sims-Siebold scissors	237
Sims	
... vaginal specula	414
... rectal specula	440, 441
... uterine curettes	431
... uterine depressors	419
... uterine scissors	235
... uterine sounds	419
Singley (Tuttle) forceps	69
Skene tenaculum forceps	182
Sluder-ballenger tonsillectomes	588
Smillie	
... meniscotomes	22
Smith-Buie anal spreaders	354
Smith-Petersen	
... osteotomes	458
... Gouges	458
... Laminectomy rongeurs	515
Smith wire cutting scissors	241, 408
Smithwick nerve hook	276
Snellen ear curette	550

Alphabetical Index

Page		Page
<p>Sonnenschein nasal specula 572</p> <p>Somer uterine elevating forceps 179</p> <p>Spackmann uterine cannula 426</p> <p>Spencer-Wells forceps 99</p> <p>Spencer stitch scissors 268</p> <p>Spratt mastoid curettes 465</p> <p>Spurling Intervertebral Disc Rongeur491:493</p> <p>St.Marks pelvis retractor 352</p> <p>St.Martin-Gomel fixation forceps ... 66</p> <p>Stacke probes 31</p> <p>Standard forceps 58 ,392</p> <p>Standard scissor 221 ,401</p> <p>Standard Trocars 43</p> <p>Staude-Moore towel forceps 183</p> <p>Steinbach mallet 453</p> <p>Steinmann tendon grasping forceps 196</p> <p>Stellbrink synovectomy rongeur 512</p> <p>Sterilizer forceps 198</p> <p>Stevens tenotomy scissor 229</p> <p>struycken nasal cutting forceps 576</p> <p>Stammerberger antrum punch 577</p> <p>St. clair-thompson adenoid curette ... 582</p> <p>Stieglitz splinter forceps 74</p> <p>Stille-Barraya grasping forceps 67</p> <p>Stille-Giertz rib shear 521</p> <p>Stille-Liston bone cutting forceps 520</p> <p>Stille-Luer bone rongeurs ... 516 ,517</p> <p>Stille-mini plaster shears 534</p> <p>Stille-Ruskin bone rongeurs 516</p> <p>Stille</p> <p>... chisels 455</p> <p>... gouges 455</p> <p>... kidney pedicle clamp 163</p> <p>... osteotomes 455</p> <p>... Plaster shears 534</p> <p>Stone grasping forceps 67</p> <p>Strabismus scissors 266 ,408</p> <p>Strandell-Stille retractor 283</p> <p>Stratte needle holder 386</p> <p>Strully neurosurgical scissor 264</p> <p>Strumpel ear forceps 556</p> <p>Swedish needle holder 377</p>	<div style="border-top: 3px double black; border-bottom: 3px double black; padding: 5px 0;"> <h2 style="margin: 0;">T</h2> </div>	<p>Takahashi nasal cutting forceps 576</p> <p>Taylor</p> <p>... blades for spreader 326 ,327</p> <p>... dura scissor 265</p> <p>... percussion hammers 599</p> <p>Teale vulsellum forceps 184</p> <p>Tendon grasping forceps 196</p> <p>Tabb</p> <p>... Knives 562</p> <p>... Crura nippers 564</p> <p>Thiersch transplantation knives 11</p> <p>Thilenius forceps 589</p> <p>Thoms-Allis intestinal forceps 157</p> <p>Thoms-Gaylor biopsy forceps 420</p> <p>Thudichum nasal specula 571</p> <p>Thorek vascular scissors 261</p> <p>Tieck-halle nasal specula 573</p> <p>Tischler-Morgan biopsy forceps 424</p> <p>Tischler biopsy forceps 421</p> <p>Tilley(Yankauer) forceps 555</p> <p>Tilley forceps 580</p> <p>Tubingen pattern vaginal retractor ... 347</p> <p>Tobold tongue depressor 586</p> <p>Toennis forceps 101</p> <p>Tonnies needle holders 376</p> <p>Tonnis-Adson dissecting scissors 231</p> <p>Tonnis (House) dissecting scissors ... 231</p> <p>Tonnis</p> <p>... d/e dura dissector 485</p> <p>... dura hooks 271</p> <p>... dura knives 20</p> <p>Toynbee ear specula 549</p> <p>Trelat</p> <p>... cleft palate needles 209</p> <p>... vaginal specula 412</p> <p>Troeltsch dressing forceps 76</p> <p>Troemmer percussion hammers 599</p> <p>Troutman-Chris razor blade holder 29</p> <p>Trousseau trachea dilator 593</p> <p>Tubbs valve dilators 370</p>



LifeCare
Surgical

www.lifecaresi.com

Area No. 3 - Block B - Nasr city,
Free Industrial Zone - Cairo - Egypt.
Phone: +202 2672 0314 - 2672 0315
Fax : +202 2672 0316
E-mail: lifecaresi@lifecaresi.com

